

QST

DEVOTED ENTIRELY TO

AMATEUR RADIO

PUBLISHED SINCE 1915 BY THE AMERICAN RADIO RELAY LEAGUE INC.

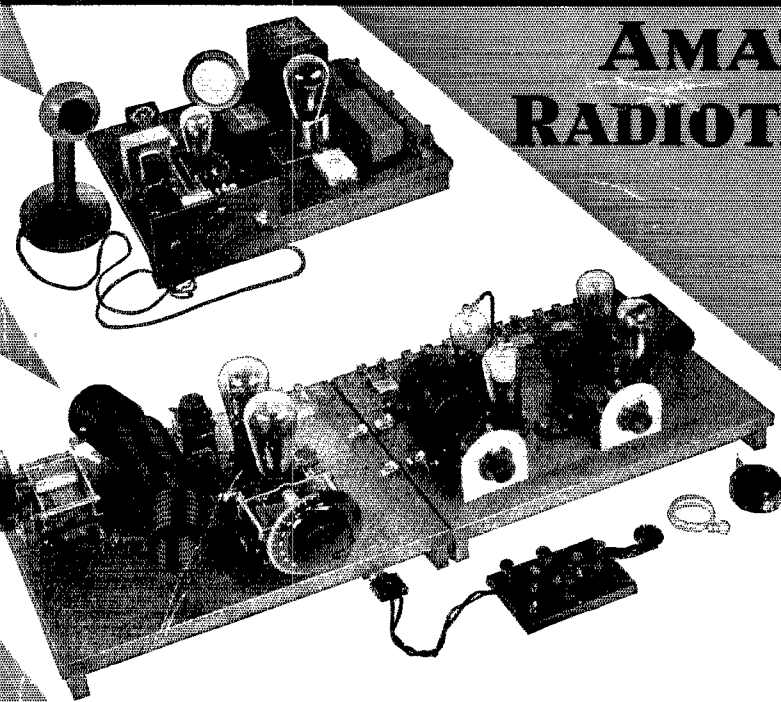

AMATEUR
RADIOTELEPHONY
AT
LOW
COST

SEE
PAGE
9

SEPTEMBER, 1929

25^c

Wouldn't You Like To
Be a Radio Amateur?
Are You Wondering
How To Go About It?

The American Radio Relay League, the national association of radio amateurs, has undertaken to make it easy for you by publishing a book designed for that very purpose. Amateurs everywhere hail it as the most valuable guide to practical amateur radio which has ever appeared.

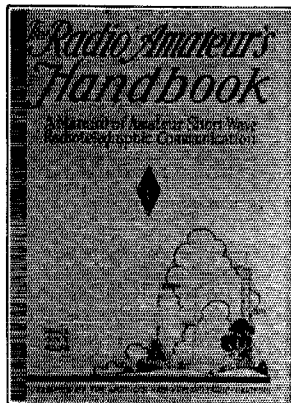

The Radio Amateur's Handbook

(FIFTH EDITION—in its 53rd thousand)

By F. E. HANDY and ROSS A. HULL
of the A.R.R.L. Headquarters Staff

Here is information about amateur radio from men who are real radio amateurs themselves, written so you can understand it. It starts in at the very beginning of the subject and tells you just what Amateur Radio is, what it's all about, how to be a radio amateur, how to get started in this most intriguing of avocations, how to learn the code, how to get your licenses, how radio works, how to build the apparatus for a simple station, how to operate a station. It has chapter after chapter on the construction of apparatus; different kinds of receivers and senders, power supplies, frequency measurement, transmitting antennas, all written so that you will be able to build them yourself and make them work. The whole story of amateur radio is in this book — its very purpose is to tell these things to the folks who are looking for the key to this great hobby.

The Handbook is printed in *QST* format, to keep the price down. In usual text-book printing style it would be a book of over 500 pages and would cost around \$5. The simpler style puts it in 200 pages like *QST*'s style and makes the price a modest \$1. It is the biggest dollar's worth of radio information you ever saw.

Break In—Let the Handbook Be Your Guide

Blue-and-gold paper cover

\$1

Stiff buckram cover

\$2

Postpaid Anywhere

American Radio Relay League, Hartford, Conn., U. S. A.

RCA

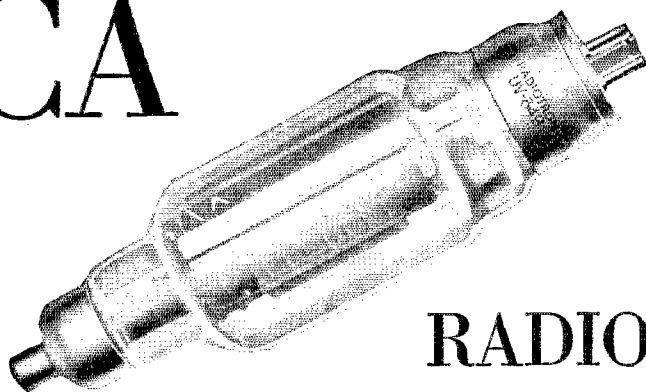

RADIOTRON UV - 849

MODULATOR, AMPLIFIER *or* OSCILLATOR

AMATEURS who operate phone transmitters of medium power will find that Radiotron UV-849 is a very effective modulator. Its characteristics have been so designed as to make it particularly suited for use with oscillators operating at plate voltages of from 2000 to 3000 volts. The high quality of phone transmission obtainable through its use will gratify the most exacting amateur.

Then too, Radiotron UV-849 will give remarkably smooth and stable performance when used either as an oscillator or as a radio frequency amplifier at frequencies below 3000 kilocycles (wave-lengths above 100 meters).

Filament Volts 11 Filament Amperes 5 Amplification Factor 19

<i>Modulator</i>			<i>Oscillator and RF Power Amplifier</i>	
Plate Volts	2000	3000 Max.	Max. Operating Plate Voltage	
Grid Bias Volts	-87	-132	Modulated DC Plate Volts	2000
Plate Current (ma.)	60	100	Non-modulated DC Plate Volts	2500
Plate Resistance (ohms)	4000	3200	Max. DC Plate Current (ma.)	350
Plate Dissipation (watts)	300	Max.	Max. Plate Dissipation (watts)	400
Oscillator Input Watts for each			Power Output (watts)	350
UV-849 (Mod. Factor 0.7)	110	350	Price	\$168.00

Write nearest RCA District Office for further information.

RADIOTRON DIVISION
RADIO-VICTOR CORPORATION OF AMERICA

New York—261 Fifth Avenue

Atlanta—101 Marietta Street

Chicago—100 West Monroe Street

Dallas—Santa Fe Building, Unit No. 1

San Francisco—235 Montgomery Street

*Shown here without
front panel*

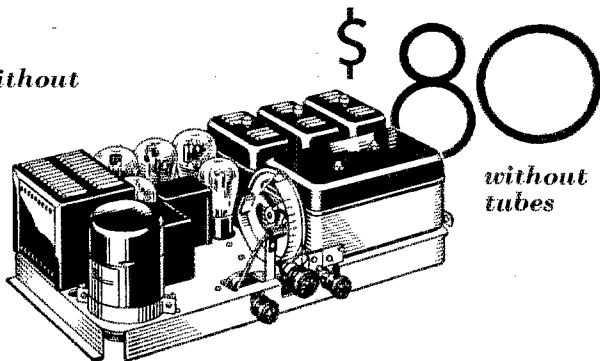

The CROSLY UNITRAD

—the “big news” in
SCREEN GRID RADIO!

ONCE more, Crosley engineering skill and Crosley straight-line mass production score! This time with the new Crosley Screen Grid Unitrad — an A.C. set, sensational in price, matchless in performance!

Just note the circuit! It utilizes **THREE** 224 Screen Grid R.F. tubes; one 227 power detector tube; one 227 heater-type first audio tube, resistance coupled; two 245 power output tubes in push pull; one 280 rectifier tube — eight in all!

Deep, natural tone is the re-

sult — razor-edge selectivity — instant response with volume *plus*. Complete elimination of howls and squeaks, too, even at the highest amplification!

Orders for the Unitrad are already flooding the factory. And dealers, everywhere are reporting lively sales. Better look into it now — call the nearest Crosley distributor *today!* Or write us direct.

The Crosley Radio Corporation
Powel Crosley, Jr., Pres.
Cincinnati, Ohio
Home of WLW

In console models, too! While the Unitrad may be used as a simple table model, for bookshelves, etc., it is also available in an extensive line of handsome Crosley consoles. Or it may be had in cabinets produced by seven of the country's leading cabinet manufacturers — all in the widest possible range of prices.

You're there with a

~~CROSLY~~

Say You Saw It in *QST* — It Identifies You and Helps *QST*

Section Communications Managers of THE COMMUNICATIONS DEPARTMENT, A. R. R. L.

Eastern Pennsylvania Maryland-Delaware-District of Columbia Southern New Jersey Western New York*	W3ZF W3BRW W3CFG W8PJ W8CEO	ATLANTIC DIVISION Don Lusk	Box 188	Ardsley
Illinois Indiana Kentucky Michigan Ohio Wisconsin	W9APY W9C9Q W9BAZ W8CEF W8BYN W9VD	CENTRAL DIVISION Fred J. Hinds D. J. Angus J. B. Wathen, III Dallas Wise H. C. Storck C. N. Crapo	1636 Thomas Ave. Box 49, R. F. D. 1 598 Masten St. 309 Third St.	Baltimore, Md. Cranbury, N. J. Buffalo Oakmont
North Dakota South Dakota Northern Minnesota Southern Minnesota	W9D9V W9DGR W9BVH W9EFK	DAKOTA DIVISION B. S. Warner D. M. Pasek Carl L. Jabs J. C. Pehoushek	3337 Oak Park Blvd. 310 N. Illinois St. Mockingbird Valley 9187 Falcon Ave. 694 Carpenter St. 443 Newton Ave.	Berwyn Indianapolis Louisville Detroit Columbus Milwaukee
Arkansas Louisiana Mississippi Tennessee*	W5ABI W5IB W5AKP W4SP	DELTA DIVISION H. E. Volte M. M. Hill J. W. Gullett James B. Witt	315 No. Jackson St. 1708 23rd Ave. 832 N. Fifth Ave.	Little Rock Oakdale Meridian Knoxville
Eastern New York N. Y. C. & Long Island* Northern New Jersey	W2CNS W2BGO W2WGO	HUDSON DIVISION F. M. Holbrook V. T. Kenney A. G. Wester, Jr.	2 Livingston Ave. 382 Wadsworth Ave. 50 Princeton St.	White Plains N. Y. C. Maplewood
Iowa Kansas Missouri Nebraska	W9DZW W9CET W9RR W9BYG	MIDWEST DIVISION H. W. Kerr J. H. Amis L. B. Lazure C. B. Deihl	915 Lincoln Ave. 8010 Mercier St. 5605 Cedar St.	Little Sioux Topeka Kansas City Omaha
Connecticut Maine Eastern Massachusetts* Western Massachusetts New Hampshire Rhode Island Vermont	W1ZL W1AQL W1ACH W1UM W1ATT W1BCR W1TT	NEW ENGLAND DIVISION C. A. Weidenhammer G. C. Brown E. R. Sharp Dr. John A. Tessmer W. W. Hodges C. N. Kraus Clayton Paulette	33 Washington Place 269 No. Main St. 9 Fairbanks St. 8 Schaffner St. 227 Main St. 92 Keene St.	Bridgeport Brewer Brookline Worcester Charmont Providence North Troy
Alaska Idaho** Montana Oregon Washington	W7WDN W7ARB W7AAT-7QT W7UN W7FD	NORTHWESTERN DIVISION W. B. Wilson H. R. McBirney G. W. Viers Wilbur S. Claypool Otto Johnson	11, S. LHT Fern 1720 Washington St. 430 "D" SE. 943 E. 30th St., S. E. 4340 30th Ave. W.	Ketchikan Boise Red Lodge Portland Seattle
Hawaii Nevada* Los Angeles Santa Clara Valley East Bay San Francisco Sacramento Valley Arizona Philippines* San Diego*	K6CFO W6UO W6AM W6NX W6CZR W6WB W6DON W6BWS K1AU W6EOP	PACIFIC DIVISION F. L. Fullaway C. B. Newcombe D. C. Wallace D. J. Quemont J. Walter Frates C. F. Banc Everett Davies Russ Shortman M. I. Felizardo Harry A. Ambler	2714 Manoa Rd. 209 Pine Ave., Room 410 1348 Hanchett Ave. 368 62nd St. 262 Castro St. Rt. 3, Box 380 519 W. Madison St. 252 Galicia St. 4101 Hamilton St.	Honolulu Yerington Long Beach, Calif. San Jose Oakland San Francisco Sacramento Phoenix Manila San Diego
North Carolina Virginia* West Virginia	W4TS W3CA W8VZ	ROANOKE DIVISION Hal S. Justice J. C. Wolford E. D. Reynolds	Box 552 118 Cambridge Ave. Box 1200	Canton Roanoke Fairmont
Colorado Utah-Wyoming	W9CAA W6BAJ	ROCKY MOUNTAIN DIVISION C. R. Stedman Parley N. James	1641 Albion St. 1430 "D" SE.	Denver Salt Lake City
Alabama Florida Georgia-So. Carolina-Cuba- Isle-of-Pines Porto Rico-Virgin Islands	W4AAQ W4AH W4RM K4KD	SOUTHEASTERN DIVISION S. J. Bayne Harvey Chafin James G. Cobble E. W. Mayer	9 Park Ave. 6002 Suwanee Ave. 1124 Mayland Circle Box 103	Montgomery Tampa Atlanta Ensenada, P. R.
Northern Texas Oklahoma Southern Texas New Mexico	W5BG W5GF W5OX W5TT	WEST GULF DIVISION J. H. Robinson, Jr. W. J. Gentry R. E. Franklin L. E. Radka	522 Cumberland St. 610 Pottenger St. 1806 Valentine St.	Dallas Shawnee Houston Tucumcari
Maritime*	VE3DQ	MARITIME DIVISION A. M. Crowell	69 Dublin St.	Halifax, N. S.
Ontario	VE3FC	ONTARIO DIVISION E. C. Thompson	266 Queensdale Ave.	Toronto, 6
Quebec	VE2BE	QUEBEC DIVISION Alex Reid	169 Logan Ave.	St. Lambert
Alberta British Columbia	VE4HA VE5BJ	VANALTA DIVISION E. J. Taylor E. S. Brooks	10107-87th Ave. 2987 Camosuit St.	Edmonton Vancouver
Manitoba Saskatchewan*	VE4HR VE4FC	PRAIRIE DIVISION A. V. Chase W. J. Pickering	109 Lanark St. 514 19th St. W.	Winnipeg Prince Albert

*Officials appointed to act until the membership of the Section concerned choose permanent SCMs by nomination and election.
**Acting for the summer.

FOR FIFTEEN YEARS

the General Radio Company has been manufacturing instruments for the amateur which have made a reputation for sound design, quality, and reliability. Among these are

Frequency Meters
Quartz Plates for
Piezo-Electric Oscillators
Audio Amplifier Transformers
Power-Supply Transformers
Variable Air Condensers (for
work on short waves)

New items are under development. Send for Bulletin 931-X and ask to receive future announcements as they appear in the General Radio *Experimenter*

GENERAL RADIO COMPANY

30 STATE STREET
CAMBRIDGE, MASSACHUSETTS

274 BRANNAN STREET
SAN FRANCISCO, CALIFORNIA



QST



The Official Organ of the A.R.R.L.

VOLUME XIII

SEPTEMBER, 1929

NUMBER 9

Editorials	7
Rocky Mountain Division Convention	8
An Effective Low-Cost 'Phone and C. W. Transmitter of Modern Design <i>James J. Lamb and Beverly Dudley</i>	9
A New Vernier Dial	18
Notes on Ethereal Adornments <i>L. G. Windom</i>	19
The President's Corner <i>Hiram Percy Maxim</i>	22
"XYL" <i>Eulalia M. Thomas</i>	23
Election Notices	24
Improving the All-Purpose Super-Heterodyne <i>L. W. Hatry</i>	25
Vacuum Tube Amplifier Definitions <i>H. F. Dart and C. K. Atwater</i>	29
Doings at Headquarters	31
W9CJC	32
Utilizing the Standard Frequency Transmissions <i>Killian V. R. Lansingh</i>	36
Finding the Expeditions	37
The A.R.R.L. Official Frequency System	38
Experimenters' Section	39
The Communications Department	42
I.A.R.U. News	58
Calls Heard	60
Correspondence Department	62
Hamads and QRAs	92
QST's Index of Advertisers	94

QST is published monthly by The American Radio Relay League, Inc., at Hartford, Conn., U. S. A. Official Organ of the A.R.R.L. and the International Amateur Radio Union

Kenneth B. Warner (Secretary, A.R.R.L.), *Editor-in-Chief and Business Manager*

James J. Lamb
Technical Editor

Beverly Dudley
Assistant Technical Editor

Clark C. Rodimon
Assistant Editor

David H. Houghton
Circulation Manager

G. Donald Meserve
Advertising Manager

Advertising Offices 55 West 42d Street, New York City
Editorial Offices 1711 Park Street, Hartford

Subscription rate in United States and Possessions, Canada, and all countries in the American Postal Union, \$2.50 per year, postpaid. Single copies, 25 cents. Foreign countries not in American Postal Union, \$3.00 per year, postpaid. Remittances should be by international postal or express money order or bank draft negotiable in the U. S. and for an equivalent amount in U. S. funds.

Entered as second-class matter May 29, 1919, at the post office at Hartford, Connecticut, under the Act of March 3, 1879. Acceptance for mailing at special rate of postage provided for in section 1103, Act of October 3, 1917, authorized September 9, 1922. Additional entry at Concord, N. H., authorized February 21, 1929, under the Act of February 28, 1925.

Copyright 1929 by the American Radio Relay League, Inc. Title registered at United States Patent Office. Member of the Radio Magazine Publishers' Association.

The American Radio Relay League

The American Radio Relay League, Inc., is a non-commercial association of radio amateurs, bonded for the promotion of interest in amateur radio communication and experimentation, for the relaying of messages by radio, for the advancement of the radio art and of the public welfare, for the representation of the radio amateur in legislative matters, and for the maintenance of fraternalism and a high standard of conduct.

It is an incorporated association without capital stock, chartered under the laws of Connecticut. Its affairs are governed by a Board of Directors, elected every two years by the general membership. The officers are elected or appointed by the Directors. The League is non-commercial and no one commercially engaged in the manufacture, sale or rental of radio apparatus is eligible to membership on its board.

"Of, by and for the amateur," it numbers within its ranks practically every worth-while amateur in the world and has a history of glorious achievement as the standard-bearer in amateur affairs.

Inquiries regarding membership are solicited. A bona fide interest in amateur radio is the only essential qualification; ownership of a transmitting station and knowledge of the code are not prerequisite. Correspondence should be addressed to the Secretary.

DIRECTORS

President
HIRAM PERCY MAXIM
Drawer 2102,
Hartford, Conn.

Vice-President
CHARLES H. STEWART
St. David's, Pa.

Canadian General Manager
A. H. K. RUSSELL
5 Mail Bldg.,
Toronto, Ont.

Atlantic Division
EUGENE C. WOODRUFF
234 W. Fairmount Ave.,
State College, Pa.

Central Division
CLYDE E. DARR
137 Hill Ave., Highland Park,
Detroit, Mich.

Dakota Division
C. M. JANSKY, JR.
Dept. of Elec. Eng., U. of M.
Minneapolis, Minn.

Delta Division
BENJ. F. PAINTER
424 Hamilton Nat'l Bank Bldg.,
Chattanooga, Tenn.

Hudson Division
A. LAFAYETTE WALSH
220 West 42d St.,
New York City

Midwest Division
PORTER H. QUINBY
817 Lauderman Building,
St. Louis, Mo.

New England Division
FREDERICK BEST
13 East Crescent St.,
Augusta, Maine

Northwestern Division
K. W. WEINGARTEN
3219 No. 24th St.,
Tacoma, Wash.

Pacific Division
ALLEN H. BABCOCK
65 Market St.,
Southern Pacific Co.,
San Francisco

Roonoke Division
W. TREDWAY GRAVELY
Box 245,
Danville, Va.

Rocky Mountain Division
PAUL M. SEGAL
Box 1771,
Denver, Colo.

Southeastern Division
HARRY F. DOBBS
245 Spring St., N. W.,
Atlanta, Ga.

West Gulf Division
FRANK M. CORLETT
2515 Catherine St.,
Dallas, Tex.

OFFICERS

President HIRAM PERCY MAXIM, Hartford, Conn.
Vice-President CHARLES H. STEWART, St. David's, Pa.
Secretary KENNETH B. WARNER, Hartford, Conn.
Treasurer ARTHUR A. HEBERT, Hartford, Conn.
Communications Manager F. EDWARD HANDY, Hartford, Conn.

ADDRESS ALL GENERAL CORRESPONDENCE TO THE EXECUTIVE HEADQUARTERS AT HARTFORD, CONN.

EDITORIALS

ELSEWHERE in this issue appears the customary annual advertisement in solicitation of nominations for A.R.R.L. Director in certain of our divisions. It is part of the operation of A.R.R.L.'s normal machinery of government. This seems a good time to present a few thoughts about that form of government.

The American Radio Relay League is proud of its form of government. It is ideal; it has stood every test. Under our constitution the United States is divided into thirteen divisions. The membership in each of these divisions, by nominating petitions and then by balloting, chooses one of its members to be a director. Similarly the amateurs in Canada (and Newfoundland and Labrador) choose one of their members to be the director known as Canadian General Manager. Then these fourteen men elect a president and a vice-president, and the whole sixteen constitute our Board of Directors. They meet periodically to go over A.R.R.L. affairs with a fine-tooth comb. The League pays the expenses for these meetings, several thousand dollars each. The sessions generally last two days. One such meeting was held in May, as reported in a recent issue. With just one single exception on the part of one director who was ill, every director has attended every meeting since the League adopted its present constitution in 1923.

Here is the finest type of representative government. It is typical of the way things are done in a democracy. It is as sound as the government of our country, and that's pretty solid. Amateur position and prestige today are attributable to the wisdom, the foresight, the experience and the hard work of this Board. The Board is the absolute "boss" of A.R.R.L. and the League is exactly what the Board makes it.

On the other hand, the Board is exactly what the membership makes it. Each member has a vote in the choice of his director. Do we seem to hear some grumbling against the Board? We suppose it's only natural. One knows that everybody can't be suited all the time, and in the quest of the wisest decisions on difficult problems there are bound to be cases where somebody isn't satisfied. If the membership doesn't like the personnel of the Board, it is its inalienable privilege to change that personnel at election time. Elections are about to be held in half of the divisions — that is the purpose of the announcement referred to. Whenever the membership doesn't like the

Board, whether that Board is good, bad or indifferent, the membership's plain duty is to elect the best possible men as directors and then give them loyal cooperation as its spokesmen, always remembering that this League is run on the old and familiar platform of the greatest good to the greatest number. Our directors are human beings and doubtless some of them possess more vision than others, but they are all amateurs, all loyal, all giving whole-heartedly of their time and energy on behalf of amateur radio. If a director isn't every thing he should be, it's nobody's fault but the membership of the division that elected him — the division membership chooses its own spokesman. It's just like Congress — the Board is under the obligation of accepting into its number whomever the membership of a division picks as its representative, and nobody else has the right to speak for that division. If the members decide they don't like their choice, they have the privilege of changing it when the next election rolls around.

Such an opportunity is now offered in half our divisions, the other half having had elections last year. Members should understand that they are earnestly invited to name, work for and vote for the man of their choice as their director, because when the vote is cast and a choice is made by the majority they are just as earnestly urged to cooperate with that director until the next election occurs. There's nothing new about that idea — it's typical of American government.

AT the recent meeting of our Board it was apparent that there is strengthening sentiment around the country in favor of the abolition of A.C.C.W. and I.C.W. Unnecessary modulation causes unnecessary interference, and in cases where the transmitter itself is not nicely stable it means that "wobulation" occurs, with a broad interfering signal that has no right on the air these days. The Board is loath to seek a regulation against modulated plate supplies, however, because it feels that every amateur ought to be free to use anything that he can make perform properly and because our Technical Development Program has demonstrated that it is possible to avoid "wobulation" from modulated plate supplies.

The answer to this problem remains in the hands of the individual amateur. Alternating-current plate supply is the cheapest and simplest.

It can be made to produce a good clean hard signal if the precautions outlined in *QST* are observed to avoid "wobulation." The chief precautions are the use of high-C circuits and, if full-wave self-rectification is used, the employment of some method to make the two halves of the circuit work on exactly the same frequency. *QST* has explained this very fully. If these precautions are not taken, then A.C.C.W. remains just what it has always been in a bum transmitter — a terrible nuisance in the form of an emission which zigzags back and forth over a wide band at the modulation frequency, obliterating everything inside its limits. Obviously this can't be permitted to go on indefinitely. Amateurs who desire to retain the benefit of the

cheapness and simplicity of A.C.C.W. must consider themselves under the obligation of rebuilding their transmitters so that they put out "1929 signals," or something will have to be done about a.e. supply.

The ideal signal is pure C.W. Trick modulations are to be avoided like poison. They give "individuality" at short range, perhaps, but they make "selfish signals" that prevent somebody else from operating, and at greater ranges their efficiency is vastly reduced. So long as we use heterodyne reception (and nobody has discovered a better method) the clean and steady unmodulated C.W. signal will win every time, in range, reliability, and reception through interference and atmospherics.

K. B. W.

Rocky Mountain Division Convention

Sept. 6th and 7th at Denver, Col.

THE Argonaut Hotel has been chosen as the headquarters for this year's Annual Rocky Mountain Division Convention to be held in Denver Sept. 6th and 7th under the auspices of the Associated Radio Operators Club. A fine program has been prepared; good speakers on timely subjects have been obtained, and the entertainment committee will do its best for every one. A.R.R.L. Headquarters has promised that Treasurer-Fieldman Hebert will attend. A cordial invitation is extended to all.

Strays

All amateurs, and the West Coast gang in particular, will be interested in the reason for the unusually long absence of VE5GO from the air. The achievements of Earle Chang, the owner and operator, in high frequency work have recently attracted the attention of the Nationalist Government of China and negotiations were opened with the result that on February 2d Earle sailed from Vancouver on the *Empress of Russia* to take an important post in the Radio Bureau of the Nationalist Government. With him he took a complete 1929 t.p.t.g. transmitter, an exact duplicate of the "High-power 1929 Transmitter" and also a 1929 receiver using the peaked audio system, all as described in *QST*. Not only has one of the best-known hams on the West Coast transplanted himself to China "complete with station," but also the A.R.R.L. will have a staunch supporter in China holding what, in all probability, will develop into a high government position in the Radio Bureau. — E. A. Westlake, S. S. Griffco.

When referring to the Handbook in letters to

the Technical Information Service, please mention the edition number. There are now five editions and the same material does not always occur on corresponding pages of all editions.

The secondary of an Eria 1000-cycle peaked audio transformer shunted by a 500- μ fd. fixed condenser is the feline's love call as the impedance (in place of the Ford coil secondary) in the plate circuit of the 222 tuned audio amplifier.

—W9EUZ.

W5CNZ found that a burned-out 2 e.p. bulb could be substituted for the resistor used to drop the plate voltage for the oscillator in his oscillator-amplifier transmitter *a la* September, 1928, *QST*. The plate voltage supplied to the 852 in the amplifier is 1000, and using a 210 in the oscillator the drop through the burned-out bulb is 800 volts.

W5KX uses three mercury arcs to rectify his three-phase plate supply with a pair of 2-ampere tungar bulbs in a full wave keep-alive for all three arcs. Individual keep-alive chokes are used in the feed to each arc, but only one arc will operate unless a 1½ henry choke is connected in the positive high-voltage lead from each arc before the leads are connected together.

Victor T. Schmitt of St. Louis went on a still hunt for mercury to equip his variable with mercury contact *a la* R.E.L., snaffled it from the back-porch thermometer, lost track of the temperature and next morning found his Ford in the yard with a frozen and busted water-jacket. Moral: If you must gyp the thermometer, do it in the summer.

Correction on Modulometer Article

Footnote 2 at the bottom of page 14 of August, 1929, *QST* should be corrected to read, "The accuracy of measurement is within 5 per cent —."

An Effective Low-Cost 'Phone and C.W. Transmitter of Modern Design

This transmitter, heralded in the August issue of QST, has more than come up to the fondest expectations not only on the score of performance but also in low cost of construction. It places the oscillator-amplifier type of transmitter in the price range of the self-excited rig of equivalent power output.

—EDITOR.

By James J. Lamb, Technical Editor, and
Beverly Dudley, Assistant Technical Editor

IN order that it may be of maximum value to the greatest number, an amateur transmitter, 'phone or C.W., must be designed to give the greatest possible return in effective miles-per-watt per dollar expended. The actual attainment of this ideal combination of

fore, need not so much guard against reckless abandon in designing the expensive technically idealistic sort of rig but rather must we beware of becoming niggardly in providing sufficient equipment of the right type to give us our money's worth in ultimate performance. There is many an

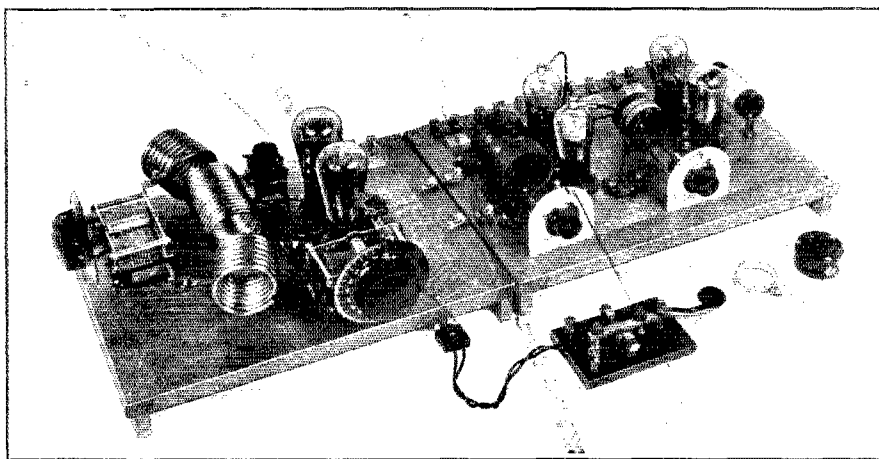

THE RADIO-FREQUENCY PORTION OF THE TRANSMITTER READY FOR 3500-KC. C.W. OPERATION

The push-pull oscillator with the resonant choke in its grid circuit is at the right. The screen-grid buffer-amplifier stage is at its left and the power amplifier follows. The split antenna inductance is mounted on the antenna tuning condenser at the extreme left. Pilot "midget" condensers, equipped with white cardboard for marking calibration, are used for tuning the oscillator and buffer-amplifier plate circuits. The neutralizing condensers are the double-spaced midgets mounted vertically to the left of the power amplifier tubes. In the foreground are the key, tuning lamp and a crystal mounting which may be plugged in the oscillator grid circuit replacing the resonant grid inductance.

technical and economic balance is indeed a nice problem, for it is easy enough, on the one hand, to be carried away by technical idealism at the expense of economy in cost, and, on the other, to be stampeded by parsimony to the detriment of truly effective design.

We hams are not all located on Wall Street, nor do we have at hand the facilities and personnel of a G. E. Research Laboratory. Most of us, there-

otherwise good set in which an apparently slight change in design in the interest of false economy has resulted in a relatively enormous sacrifice of performance. It pays to be sure a penny-wise design may not pan out a pound-foolish flop. Fortunately, there is a point at which satisfactory economy in cost can be realized with no considerable sacrifice in performance, and the transmitter presented in this article may be considered

as very nearly representing the optimum in economy with thoroughly effective performance.

Features of the transmitter which may be specifically given in advance of the detailed description are:

1. Effective performance on both 'phone and C.W. On 'phone the carrier output is of the order of 7 watts which, modulated by the 100 per cent

retail, and at usual "ham prices" prevalent in the United States the cost should be considerably less. The total outlay, including plate supply, filament transformer and bias batteries, should not exceed \$150.00.

3. The simple design, construction and adjustment together with the wide availability of the parts specified should make it possible for the

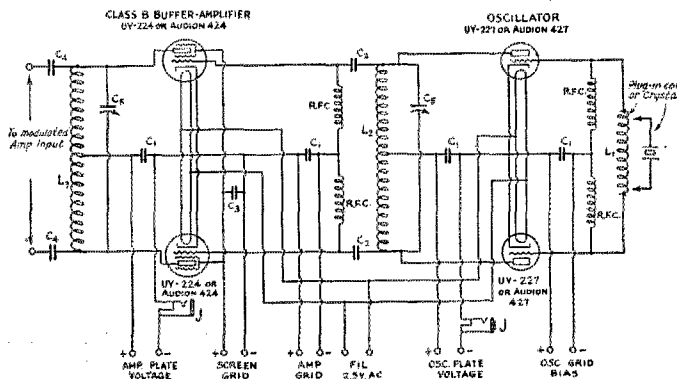

FIG. 1.—THE OSCILLATOR AND BUFFER-AMPLIFIER CIRCUIT

L_1 —110 turns of No. 26 d.c.c. wire on a 1-inch diameter tube for 3500-ke. band; 55 turns for 7000 ke., 27 turns for 14,000 ke. and 220 turns for 1750 ke.

L_2 —For crystal control (low C); 20 turns of No. 20 d.c.c. on a 2-inch diameter tube for 3500 ke., 10 turns for 7000 ke., 5 turns for 14,000 ke. and 40 turns for 1750 ke. All coils should be center-tapped.

L_3 —For self-control (high C); 10 turns of No. 20, d.c.c., on a 2-inch diameter tube, shunted by a 500- μ fd. fixed condenser for 3500 ke.; 6 turns shunted by a 200- μ fd. fixed condenser for 7000 ke.; 4 turns shunted by a 100- μ fd. fixed condenser for 14,000 ke., and 20 turns shunted by a 500- μ fd. fixed condenser for 1750 ke. All coils are center-tapped. Some variation from the above specifications may be required in obtaining the exact frequency coverage desired. It must be remembered that 'phone operation is legal on the 3500- to 3550-ke. and 1715- to 2000-ke. bands only (at this writing).

L_4 —20 turns of No. 20 d.c.c. wire on a 2 1/2-inch diameter tube for 3500 ke., 10 turns for 7000 ke., 5 turns for 14,000 ke., and 40 turns for 1750 ke. All coils are center-tapped.

If rapid QSY from band to band is desired, L_2 and L_3 may be made "plug-in."

C_1 —1000- μ fd. Sangamo receiving type fixed condensers.

C_2 —100- μ fd. Pilot fixed condensers.

C_3 —0.5- μ fd., 300-volt Tobe by-pass condenser. A .002- μ fd. or larger fixed condenser might be used.

C_4 —250- μ fd. Pilot fixed condensers.

C_5 —100- μ fd. Pilot 2 1/2-plate midget variable condensers.

J—Closed circuit jacks for plate milliammeter.

R.F.C.—400 turns of No. 36 d.s.c. wire on 3/4-inch wooden dowel, tapped at center, for 3500 and 1750 ke. Use half as many turns for 7000- and 14,000-ke. bands.

system, gives a peak output of over 25 watts. Satisfactory frequency stability, with or without crystal control, is attained on both 'phone and C.W.; and when used as a C.W. telegraph transmitter, proper adjustment permits a power output of 15 watts.

2. Minimum cost compatible with maximum effective power output. This economy is made possible by the use of comparatively inexpensive receiving type tubes requiring low plate voltages, permitting the use of low voltage transmitter parts and plate supply. The total cost of the parts for the C.W. portion of the transmitter should not exceed \$50.00, tubes included, while the speech amplifier and modulator unit components represent an outlay of about \$40.00. These prices are

ham-in-the-street to completely duplicate the transmitter as well as performance.

CONSTRUCTION

To make the transmitter as adaptable as possible, it was built up in three units; the oscillator buffer-amplifier unit, the modulated amplifier unit, and finally the speech amplifier and modulator unit. The photographs show the general appearance of the three units as well as the bottom view of the two radio frequency units. It will be noted that the "bread-board" style of construction has been followed throughout. This type of construction permits accessibility of all units and wiring, is economical, and is easily executed. Furthermore, such construction per-

mits a considerable portion of the wiring to be done below the supporting baseboard, so the top of the unit presents a neat clean-cut appearance. The bread boards used in the radio-frequency portion of the transmitter were 12 inches by 16 inches, and were given two coats of Duco colorless finish. The 12-inch by 18-inch modulator board was finished in a similar manner. All connections on the two radio-frequency boards are made with Fahnestock clips, while 'phone jacks

possess a suitable crystal may obtain results very nearly as satisfactory in the manner to be described.

It is well known that when the grid and plate circuits of a vacuum tube contain resonant elements the circuit will oscillate at a frequency determined by the constants of these elements. Under such conditions, the tube will oscillate at radio frequencies over a considerable range with a fixed-tune grid circuit element, the frequency of

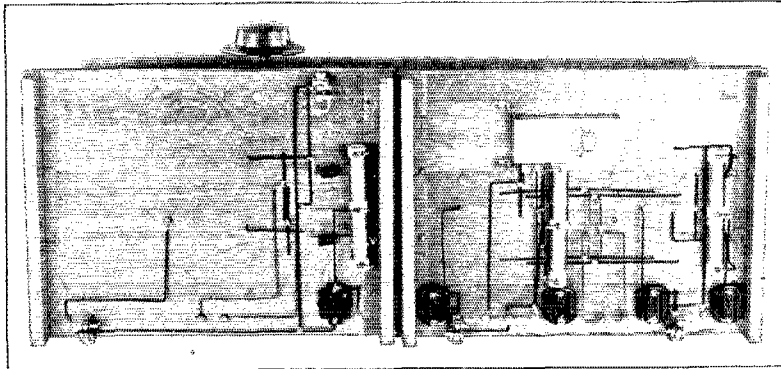

EQUIPMENT AND WIRING BENEATH THE BASE-BOARDS

The r. f. portion of the transmitter tipped up on its back edge; oscillator and buffer-amplifier to the right, power amplifier to the left. The center-tapped grid circuit chokes line up along the center and the supply by-pass condensers along the bottom. The jack at the top, to the right of the power amplifier plate condenser dial, is for the telegraph key while the three jacks along the bottom are for the plate milliammeter. The parasitic chokes in the power amplifier tube grid circuits are to the left of the center-tapped choke on the left-hand base-board.

and plug and a battery cable are used in addition to the clips on the modulator board.

THE OSCILLATOR AND BUFFER-AMPLIFIER

While it is highly desirable that the output frequency of a high-frequency 'phone transmitter be controlled by a quartz crystal, the purchase of a crystal and holder represents a considerable investment for the average amateur. Although the technical reasons for a "self-controlled"¹ oscillator were rather exiguous, it was realized that there was an economic as well as a technical problem involved, and an oscillator was designed which could be made self- or crystal-controlled with no greater modification than the substitution of a resonant choke coil for the quartz plate in the grid circuit of the oscillator and a high-C tuning unit in its plate circuit. For those amateurs who have crystals, we heartily recommend the use of quartz plates, although any who do not

oscillations in this case being determined by the inductance and capacitance in the plate circuit. If a fixed-tune choke coil is used to replace the quartz plate of a crystal-controlled oscillator, we obtain a tuned-grid tuned-plate type of oscillator with only one variable tuning adjustment — the tuning condenser in the plate circuit. The resonant choke coil permits QSY over a frequency band sufficiently wide for practical purposes when battery bias is employed,² and by simply varying the plate circuit tuning, we have a very excellent means of quickly shifting the frequency. At the same time the screen-grid buffer-amplifier effectively prevents the antenna circuit and power amplifier from reacting upon the oscillator, so that the power output and frequency stability when using the high-C self-controlled oscillator compares favorably with the output and stability when using the crystal-controlled oscillator. As may be seen from the photographs, the grid circuit of the oscillator is provided with two switch jaws, into which the resonant choke coil

¹ "Self-controlled" is suggested for designating the type of oscillator circuit in which the frequency of oscillation is determined by the LC constants, as contrasted with the "crystal-controlled" type oscillator wherein the frequency of oscillation is determined by the oscillation frequency of a quartz crystal. While the term "self-excited" is often used in this sense, it is more specifically applicable to the specification of the source of excitation than of the type of frequency control. As a matter of fact, both "self-controlled" and "crystal-controlled" oscillators are self-excited.

² When grid bias is obtained by the use of a grid leak resistor, no bias is available until grid current flows, which does not occur until the tube starts to oscillate. This is evidenced by the "lag" in going into oscillation as the circuit is tuned. With battery bias, the oscillations are more easily started and persist over a wider range of tuning adjustment.

may be inserted as shown or into which the crystal holder may be plugged.

The oscillator uses two UY-227 tubes in a push-pull arrangement. The use of the indirectly heated cathode type of tube is a considerable improvement over the use of the directly heated cathode type in the elimination of low frequency hum when alternating current is utilized to heat the filament. The operating characteristics of the UY-227 are identical with those of the UX-

boiling in paraffin wax. It is essential, in order to preserve the balance of the circuit, that both halves of the choke be identical.

When the oscillator is to be of the self-controlled type the resonant choke, L_1 , will be required. This choke consists of 110 turns of No. 26 d.c.c. wire wound on a bakelite tube 1 inch in diameter for 3500 kc. If it is definitely decided not to use crystal control, this coil should be tapped at the center, the center tap being connected to the oscillator negative grid bias. The choke coils, RFC, as mentioned above, may then be eliminated.

The plate circuit, when a quartz crystal is used to control the frequency, contains the inductance, L_2 , shunted by the 100- μ fd. Pilot midget receiving condenser. For 3500-kc. operation L_2 consists of 20 turns of No. 20 d.c.c. wire, wound on a bakelite tube 2 inches in diameter and center-tapped, or else in two sections, both wound in the same direction, of 10 turns each. When the oscillator is to be self-controlled, the plate circuit should be of the high-C type so that maximum frequency stability may be realized. This is accomplished by reducing the number of turns in the plate coil and augmenting the capacity across it by means of a fixed receiving type condenser of proper capacity. For the 3500-kc. 'phone band, the coil should contain 10 turns, center-tapped, and the fixed condenser should be of 500- μ fd. capacitance. Specifications of high-C plate circuit tuning units for the other amateur bands are given in Fig. 1. It may be found that a slight variation from the number of turns specified may be necessary, as the actual capacitance of commercial fixed condensers often varies considerably

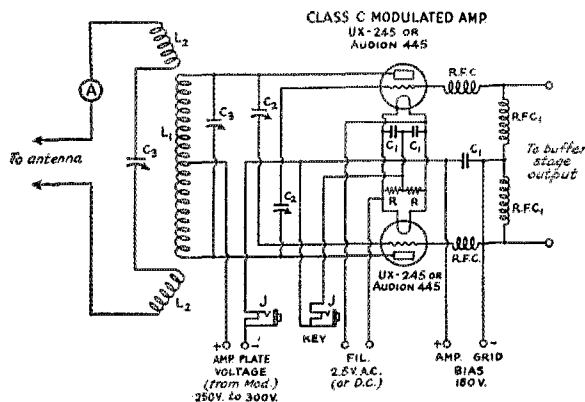

FIG. 2. — THE POWER AMPLIFIER CIRCUIT

L_1 — 16 turns of $\frac{3}{16}$ -inch copper tubing, 2-inch inside diameter, center-tapped for 3500 and 7000 kc. 52 turns No. 12 enameled copper wire, space wound and center-tapped, for 1750 kc. 6 turns $\frac{3}{16}$ -inch tubing for 14,000 kc., also center-tapped. These coils may also be made "plug in" for rapid QSY.

L_2 — 6 turns $\frac{3}{16}$ -inch copper tubing, 2-inch inside diameter. Both coils wound in same direction.

R.F.C. — 16 turns of No. 20 wire wound on $\frac{1}{2}$ -inch dowel and then removed from form and doped with Duco.

R.F.C.A. — Same as R.F.C. in Fig. 1.

C_1 — 1000- μ fd. Pilot fixed condensers.

C_2 — Pilot 100- μ fd., 23-plate midget condensers spaced by removing alternate plates so that capacity is reduced to about 25 μ fd.

C_3 — 350- μ fd. or 500- μ fd. Cardwell receiving type variable condenser.

J — Closed circuit jacks.

201-A tube with the exception of the filament or heater characteristics. Therefore receiving type components may be used entirely and the cost of the transmitter becomes very moderate.

There is nothing unusual or complicated about the oscillator. It is simply a standard push-pull job. A center-tapped choke coil is provided so that each grid may obtain its proper bias whether the crystal or the resonant choke coil is used. If a self-controlled oscillator were to be used exclusively, the grid chokes in the oscillator could be eliminated if the resonant choke were provided with a center tap. The elimination of this choke is not possible when the oscillator is crystal-controlled or when either the self-excited or the quartz-controlled type of oscillator is to be used at will. The choke coil consists of 400 turns of No. 36 d.s.c. wire wound in two sections of 200 turns each on a $\frac{3}{4}$ -inch wooden dowel rod, which preferably should be treated against moisture by

from that indicated on the label. The oscillator output circuit is coupled capacitively to the buffer-amplifier input circuit through two 100- μ fd. Pilot fixed receiving condensers.

Radio frequency by-pass condensers, C_1 , are used across the grid bias and plate supply leads. A word might be said at this point regarding the use of by-pass condensers in push-pull circuits. If the circuit is carefully built so that one side of the push-pull circuit is electrically identical with the other side of the circuit there should be no radio frequency currents flowing in the grid and plate return leads, the cathode circuits, or the center-tapped filament circuit, and the condensers may then be eliminated. However, the condensers are cheap insurance, easily procurable, and it is believed that their use is well warranted.

THE BUFFER-AMPLIFIER

Coming as it does upon the heels of the above

insistence upon economy in design of the amateur transmitter, the specification of a buffer-amplifier in such a simple transmitter as this may seem to some a reversion to extravagance. Such, however, is not at all the case. The buffer-amplifier has a dual and necessary function in an oscillator-amplifier type of transmitter, whether it be intended for use on 'phone or C.W. It serves to provide a voltage and power gain between the oscillator and power amplifier and at the same time prevents the unavoidable variations in power amplifier constants due to modulation or keying from reflecting back into the oscillator circuit and thereby causing undesirable variation in the oscillator frequency. The use of such a buffer stage is heartily recommended in any oscillator-amplifier type transmitter, crystal-controlled or otherwise. Its use in many C.W. transmitters at present afflicted with serious feed-back from the amplifier to the oscillator with the certain accompaniment of frequency flutter and creeping would be decidedly an advantageous investment. Some crystal-controlled transmitters never seem to grow up — they always creep.

The buffer-amplifier uses two UY-224 screen-grid tubes, which, like the UY-227 tubes, have indirectly heated cathodes. The grid circuit of this amplifier, like the oscillator, contains two radio-frequency chokes. The chokes are constructed exactly like those used in the grid circuit of the oscillator, which have already been described.

The plate circuit of this amplifier contains another 100- μ fd. midget tuning condenser shunted across the coil, L_3 , which consists of 20 turns of No. 20 d.c.c. wire on a 2½-inch bakelite tube. The inductance, L_3 , is either center-tapped, or wound in two sections, the same as L_2 . The output of the screen-grid amplifier is taken from the two Fahnestock clips at the extreme left of the oscillator-amplifier panel, to which are connected the two output coupling condensers of 250- μ fd. capacitance each.

Care should be taken to make all of the filament supply wires heavy and of equal length. The current drawn by two -27 and two -24 tubes is 7 amperes, and the filament wires must be sufficiently heavy to carry this current. Not only must the filament wires be sufficiently heavy to carry the current, but they must be sufficiently large so that excessive IR drop will not occur in the leads. As the filaments of the four tubes are all connected in parallel, it is essential that the length of the leads to any tube from the filament supply binding posts be identical with the length of any, or all, of the other filament leads to the supply posts. If this point is overlooked the drop in some filament lines will not be the same as that of other filament lines and the tubes will operate with different filament voltages. The bottom view of the oscillator-amplifier unit will show the care which has been exercised in this respect to keep all filament leads of equal length.

Closed circuit jacks are provided in the negative side of the plate voltage leads of both the -27 and the -24 tubes. A plate milliammeter provided with a cord and telephone plug is inserted into the proper jack for the determination of the plate current in either the oscillator or the amplifier. Thus, one 0-100 milliamperere meter will measure the plate current of all of the tubes in any circuit, thereby affecting economy by not requiring a multiplicity of meters.

By-pass condensers are used across the grid, screen grid, and plate supply terminals of the buffer-amplifier. The condensers C_1 are 1000- μ fd. mica insulated receiving condensers, while C_2 is a 0.5- μ fd., 750-volt Tobe filter condenser. For this larger condenser, C_3 , a 1000- μ fd. receiving condenser the same as C_1 , could be substituted.

The photographs both of the top and bottom of the oscillator-amplifier unit, together with the detailed wiring diagram of Fig. 1, should permit any amateur worthy of the name to duplicate this unit. There is no neutralizing or laborious testing to be done.

THE MODULATED AMPLIFIER

Like the oscillator and buffer-amplifier unit, the modulated amplifier uses receiving parts exclusively. The only indication of any transmitting equipment in the entire transmitter is the set of three coils made of 3/16-inch copper tubing. The final amplifier makes use of the UX-245 type tubes, which, because they are directly heated, require a filament center-tap resistor. Two 50-ohm Yaxley units connected in series serve the purpose, while two 1000- μ fd. fixed receiving condensers serve for the radio frequency by-pass in the filament circuit. Another 1000- μ fd. by-pass receiving condenser is employed as a radio frequency by-pass across the amplifier grid bias battery.

It should be noted that no by-pass condenser is employed across the plate supply terminals of the power amplifier. The reason for the omission of this by-pass condenser is that the plate voltage for this amplifier is obtained from the plate circuit of the modulator tube, and since plate voltage variations of the modulator tube (and consequently of the modulated amplifier tubes) occur at audio frequencies, the higher audio frequencies would be by-passed if this condenser were used across the plate voltage terminals. A 1000- μ fd. by-pass condenser may be used in this position if the transmitter is to be used exclusively for telegraph transmission, however.

The choke coils used in this amplifier are identical with those used in the grid circuits of the oscillator and screen-grid buffer-amplifier, constructional data for which have already been given. The tank inductance of the modulated amplifier, L_1 of Fig. 2, consists of 16 turns of 3/16-inch copper tubing, center-tapped. In making the

tap on this coil, a piece of angle brass is soldered to the mechanical center of the coil, the angle brass being bent into the shape of an "L." With the top part of the L-shaped angle brass soldered to the center of the coil and the bottom piece drilled and bolted to the bread board, a very excellent mechanical support, together with a good electrical contact, is provided so that the coil, L_1 , is unusually firm and rigid. A 350- μ fd. Cardwell receiving type condenser is employed to tune this circuit, but since the condenser is used with practically all of the capacitance in at 3500 kc., a 500- μ fd. condenser could just as profitably be employed.

The antenna coupling coils, L_2 , are placed at both ends of L_1 and the coupling between the tank inductance and each of the two coils marked L_2 is made the same to load both sides of the circuit equally so that each of the two UX-245 tubes contributes its share of antenna power. Each coil consists of 6 turns of 3/16-inch copper tubing, 2 1/2 inches inside diameter. One end of each coil is flattened and a hole drilled in this flattened part in order to provide a pivot mounting for varying the coupling between the coils L_2 and L_1 . In winding and mounting the coils L_2 , care should be exercised to note that both of the antenna coils are wound in the same direction. If this point is not observed, the antenna current in one of the coils will neutralize that in the other coil, and little, if any, power will be radiated by the antenna system. The coils are mounted on the antenna tuning condenser as shown, the antenna condenser in this case being another 350- μ fd. Cardwell receiving type condenser. The maximum capacitance of the tuning condenser required in any given installation will depend upon the natural frequency of the antenna system or the length of the feeders if a Zeppelin antenna is used, as well as on the number of turns used in L_2 . In practice, the number of turns in actual use in each antenna coil should be the same.

NEUTRALIZATION

The amplifier is neutralized by means of two Pilot 100- μ fd. midget receiving condensers which have their alternate plates removed so the resulting capacitance of the double-spaced condensers is approximately 25 μ fd. each. With the UX-245 tubes complete neutralization is obtained when approximately one-third of the capacitance of each neutralizing condenser is in the circuit.

A jack is wired in the filament center tap of the modulated amplifier so that, by plugging a key in this jack, the radio frequency units may be used without the modulating equipment for continuous wave telegraph transmission.

Note that small choke coils to prevent parasitic oscillations are mounted as close to the grid terminals of the sockets of the UX-245 tubes as is practical. Each choke consists of 15 turns of No.

22 d.c.e. wire, wound on a 1/2-inch dowel rod, the coils being afterward removed from the dowel and made reasonably strong and self-supporting by an application of Duco. The photographs and the wiring diagram of Fig. 2 show the rest of the details clearly and further explanation should be unnecessary.

THE SPEECH AMPLIFIER AND MODULATOR

The modulating unit comprises a microphone coupling transformer, speech amplifier tube, an audio coupling transformer to the UX-250 tube, the UX-250 modulator tube, a double speech choke with its modulating amplifier plate supply resistor, audio by-pass condenser, and the 0-100 milliammeter for measuring the current of the various plate circuits. This unit is the same as the one used with the 'phone transmitter described in the March, 1929, *QST* and changed so as to use a UY-227 rather than a UX-201-A speech amplifier tube.

A microphone or modulation transformer with a low impedance primary winding of the single button type is used to couple the microphone to the grid circuit of the speech amplifier. Across the secondary of the microphone input transformer is a 200,000-ohm potentiometer which acts as a volume level control. The output of the 227 tube is fed into the grid circuit of the UX-250 modulator tube through a high quality audio frequency amplifying transformer. With single button microphones, a single stage of speech amplification is sufficient, although two stages of transformer-coupled audio frequency amplification, or its equivalent, should be employed if the less sensitive double button microphone is used.¹

The plate current for the modulator is fed from a 500-volt supply to the UX-250 tube through an audio frequency choke coil. The inductance of this choke should be in the neighborhood of 20 to 30 henries to keep the d.c. plate current constant when audio frequency voltage variations are applied to the grid of the modulator tube. A double "B" eliminator choke is used for this purpose. One portion of this choke is used in the modulated amplifier plate circuit while the other half is wired into the modulator plate circuit. The radio frequency amplifier plate current is varied at audio frequencies through the large audio by-pass condenser connecting the "high" sides of the double choke. Thus, when the voltage on the grid of the modulator tube is varied at voice frequencies and the modulator grid becomes less negative, the modulator plate current tends to increase. Due to the impedance of the two choke coils at these frequencies, the current flowing through their windings is kept constant and power is drawn by the modulator through the coupling condenser from the plates of the modulated amplifier tubes. When the grid of the

¹ For more complete data on speech amplifier design, see *QST*, August, 1929, page 13.

modulator tube becomes more negative than its normal bias, the converse action takes place. The power output of the modulated amplifier tubes varies directly as their plate power input. Therefore the antenna power is varied in accordance with the sound input to the microphone. A 5000-ohm resistor is placed in series with the choke coil feeding the modulated amplifier, as complete modulation is not possible unless the plate voltage of the modulator exceeds that of the modulated amplifier.¹

OPERATION OF THE TRANSMITTER

In operating the transmitter, the oscillator and buffer-amplifier should be made to function successfully before anything else is accomplished. The operation of this unit is simplicity itself, and should present no difficulties. With the unit correctly wired, the filaments should be lighted, and since it takes approximately half a minute for the tubes to assume their normal operating temperature, plate voltage should not be switched on for at least this length of time. Grid bias may be connected, however, and after the proper interval of time, the plate voltage should be applied to the oscillator. Since it is first necessary to get the oscillator operating properly, the grid bias, screen grid and plate voltages should not be applied to the buffer-amplifier at this time. Best operation of the oscillator is obtained with a negative grid bias of 22½ volts and a plate voltage of 180 or 200. The heater voltage should be between 2.0 and 2.5 volts. While the exact heater voltage is not critical between these values, the value of 2.5 volts should not be exceeded.

With the crystal in the circuit and all voltages applied to the oscillator tube, the oscillator tank tuning condenser should be varied until oscillation of desirable amplitude at the proper frequency is indicated. In working with low power equipment a pick-up coil and lamp, shown between the key and the crystal holder in the photograph, made of from one to three turns of No. 18 d.c.e. wire connected to a low current flashlight lamp, will be found of inestimable value. This may be better appreciated when it is known that it is possible to tune the entire transmitter with this coil and lamp as an indicator. The pick-up coil is rather closely coupled to the tank inductance, L_2 , of the oscillator circuit to indicate oscillation and relative output, after which it may advantageously be coupled more loosely. Maximum output at a given frequency will be indicated by maximum brilliance of the lamp. The normal

plate current of the UY-227 tubes when oscillating will be about 6 to 8 milliamperes. Some idea of the adjustments may be gained from the photograph since all tuning condensers were set as accurately as could be judged to their normal operating positions at the time the photograph was taken.

If a resonant choke coil is used in place of the crystal in the grid circuit of the -27 tubes, the operation will be slightly different. It will be found, when using a grid coil made up as specified, that the oscillator will give practically constant output over a goodly portion of the 3500-ke. amateur band. If this should not be the case, the choke should be altered either by adding more

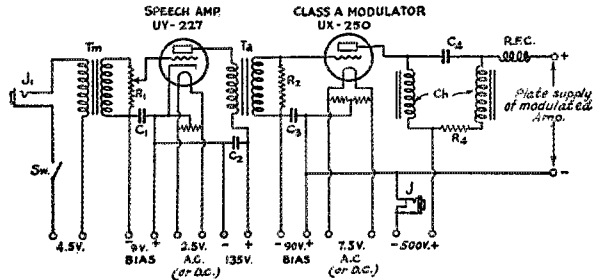

FIG. 3.—THE SPEECH AMPLIFIER AND MODULATOR

- T_m — Microphone transformer.
- T_a — Audio frequency amplifying transformer.
- Ch — National type 80 double B eliminator choke.
- C_1 — 1- μ d. by-pass condenser.
- C_2 — 1- μ d., 300-volt by-pass condenser.
- C_3 — 1- μ d. by-pass condenser.
- C_4 — 1- μ d., 1000-volt, audio coupling condenser.
- R_1 — 200,000-ohm Frost potentiometer.
- R_2 — 250,000-ohm resistor, grid leak type.
- R_3 — 100-ohm filament center-tap resistors.
- R_4 — 5000-ohm Ward Leonard No. 507-a resistor, 90 m.a., 44 watts.
- R.F.C. — Silver-Marshall type 217 or Aero type C-248 choke.
- J — Closed circuit jack.
- J_1 — Open circuit microphone jack.

turns or removing turns until this condition does obtain. When the choke is properly constructed, oscillation can be obtained over most of the amateur band and it will be necessary to determine the exact frequency of oscillation by means of a frequency meter either of the oscillating or simple absorption type. Due to the low power of the oscillator and the close coupling which will be required when the absorption type meter is employed, the latter is not recommended when other means of frequency determination are available.

After the oscillator is operating properly, grid, screen grid, and plate voltages of the buffer-amplifier should be applied. The pick-up coil should be coupled to the tank inductance, L_3 , and the circuit tuned until the lamp burns brightest. No other adjustments, with the possible exception of grid bias, should be required. With the oscillator-amplifier unit operating properly, the modulated amplifier is the next point of attack.

¹ A more detailed discussion of this system of modulation is contained in QST for April, 1929, pages 9 to 11.

The filaments of the UX-245 tubes should be lighted and the filament voltage adjusted to between 2.0 and 2.5 volts. Since the 245 tubes are directly heated, they will reach their operating temperature much more quickly than the 227 or the 224 tubes, and consequently the plate voltage may be applied sooner after the filaments are lit. Before the plate voltage is applied, however, this amplifier should be neutralized in the following manner:

With the full grid bias of approximately 180 volts and with grid excitation applied but without plate voltage on the 245 tubes, the pick-up coil is coupled to L_2 and the plate circuit is tuned to resonance. If the amplifier is not neutralized the bulb will light up indicating that power from the buffer-amplifier is being fed directly through the inter-electrode capacitance of the 245 tubes to the plate circuit. The two neutralizing condensers should then be adjusted simultaneously until the lamp shows no signs of incandescence as the plate circuit tuning is varied. The amplifier is now neutralized.

In connection with the neutralization of the amplifier, the modulometer described in the August, 1929, issue of *QST* is very effective. After the tubes are neutralized as accurately as possible by the method described above, a few turns of one antenna coupling coil are connected to the modulometer input circuit. The plate meter of the modulometer should show a very decided upward deflection if the amplifier is not completely neutralized. If incomplete neutralization is indicated, readjustment of the neutralizing condensers until the modulometer plate meter shows no deflection as the amplifier plate tuning is varied, will be necessary. The setting of the neutralizing condensers, while not extremely critical, is many times more accurate when the modulometer is used to indicate neutralization than when the lamp is employed. Neutralization may be realized with no difficulty whatsoever in push-pull amplifier circuits, and with the modulometer or any vacuum tube voltmeter as an indicator, there is no doubt as to its completeness.

When the power amplifier has been neutralized, the filament of the modulator tube should be lighted and the plate voltage applied to both the modulator and the modulated amplifier. Do not turn on the speech amplifier at this stage of the game. Satisfactory modulation cannot be expected until the modulator and modulated amplifier have been properly adjusted.

Modulated amplifiers are operated as "Class C," the bias and excitation being such that the power output varies as the square of the plate voltage.¹ The bias required is greater than, and usually double, that required to reduce the plate current to zero when no excitation is applied. The value of this bias for the 245 tubes when operated as Class C amplifiers with plate voltages

of 250 to 300 is approximately 180 volts. When so operated, the excitation should be sufficient to cause normal plate current to flow.

If an attempt should be made to experimentally determine the proper bias required for "cut-off" with this particular transmitter arrangement, a peculiar difficulty of the vicious circle variety will be encountered. As the bias is increased, no excitation being applied, the plate current decreases but the plate voltage increases due to the fact that the IR drop in the series resistor is decreasing with the reduction of plate current through it. Experimental determination of the proper value of bias is, therefore, impossible. Fortunately, however, the proper value of cut-off bias for a given plate voltage may be determined by dividing the operating plate voltage by the amplification constant or μ of the tube. For Class C operation this value may be doubled. Since the amplification factor of the 245 is 3.5 and the operating plate voltage is 250 to 300, the cut-off bias is approximately 90 volts and the proper bias for Class C operation is 180 volts.

With the proper value of grid bias thus determined and with grid excitation applied to the amplifier, its plate tank is coupled to the antenna — preferably of the dummy variety.² The coupling between the plate and antenna inductances should be adjusted so the antenna current and amplifier plate input are maximum. The coupling between each of the antenna coils and the tank inductance should be the same. It will be found that variation in the tuning of the antenna circuit will necessitate a readjustment of the plate tank condenser. Therefore it is best to make these two adjustments simultaneously. The optimum operating condition will obtain when the plate current is of the order of 30 to 40 milliamperes. When these conditions have been satisfied the modulation may be applied.

With the speech amplifier and modulator used in this transmitter, the usual single button microphone is capable of causing maximum permissible grid swing of the modulator tube with the gain control half-way on when the microphone is spoken into at normal voice intensities.

When work on the transmitter has progressed thus far, the percentage of modulation may be measured with the modulometer, if one happens to be available. Lacking such a device, complete modulation will be indicated to an approximate degree when the antenna current, as indicated by the antenna ammeter, shows an increase of about 30 per cent when a prolonged, "ohhhhh" is sounded into the microphone. A check on the quality may also be made via a monitor — and the transmitter is ready to go on the air.

The dummy antenna should be replaced by the regular operating and radiating antenna. Necessary readjustments of the antenna and plate tank tuning condensers should be made. "CQ," "test,"

¹ See "Vacuum Tube Amplifier Definitions," this issue.

² Figure 6, page 15, *QST*, August, 1929.

or any other of the cryptic utterances peculiar to amateur radio telephony may now be spoken into the microphone with reasonable assurance that they will be heard.

The foregoing may seem to be a rather elaborate process for the adjustment of a simple 'phone transmitter, but considerable experimental work has proved that this method is the most effective and quickest for obtaining real quality results.

So much for the adjustment as a 'phone transmitter. In addition, the set also has unusual possibilities as a C.W. transmitter and when used as such requires slightly different adjustment for best results.

In a continuous wave telegraph transmitter, a key is employed to open and close some portion of the circuit to alternately start and stop the radiation of radio frequency waves. Voice modulation is comparatively "smooth" and may vary in a particular word or syllable over a considerable range of amplitudes. With C.W. transmission, however, modulation is from zero to maximum amplitudes only with the result that these sudden and great differences in load require a buffer amplifier as good as, if not better than, that required for a 'phone transmitter. This is a point which, apparently, is not generally appreciated in practice since, even with crystal-controlled oscillator-amplifier transmitters, the frequency is often noticed to vary appreciably with keying. In this particular transmitter, even a direct short circuit of the output of the buffer-amplifier has little reaction on either the oscillator frequency or power output. It is, therefore, when properly adjusted, an excellent C.W. transmitter as well as an effective 'phone transmitter.

For C.W. transmission, the oscillator and buffer-amplifier are used in exactly the same manner as for 'phone transmission, but the power amplifier is operated as Class B rather than as Class C. When operating as a Class B amplifier, the grid bias is of such value that, without grid excitation, the plate current is near zero. This condition is obtained with a grid bias of 90 volts when the plate voltage is 250 to 300. Correspondingly higher values of grid bias would be required for higher plate voltages. The modulator should be dispensed with and the plate voltage to the UX-245 tube should be adjusted to 250 or 300.

The power output of this transmitter when adjusted for C.W. operation is approximately

double the carrier output obtained when it is operated on 'phone. This means that the antenna current on C.W. is about 40 per cent greater than the carrier antenna current when voice transmission is employed. It is possible to deliver about 1 ampere to the feeders of a fundamental 3500-ke. Zeppelin antenna on C.W. as compared to 0.7 ampere for the carrier on 'phone.

The key is connected in the filament center tap of the final amplifier. This arrangement permits the oscillator and buffer-amplifier to operate con-

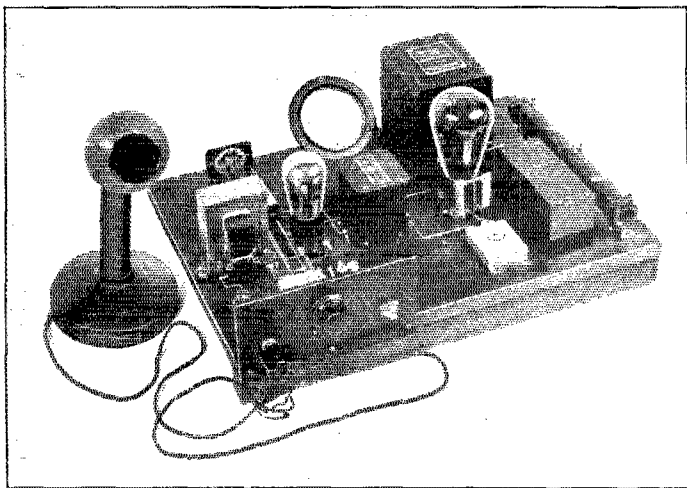

THE SPEECH AMPLIFIER AND MODULATOR UNIT

This unit is the same one used with the transmitter described in the April issue of QST with the exception that a -27 type a.c. tube is used in the speech amplifier. The milliammeter, equipped with a cord and telephone plug, is used for measuring current in all plate circuits of the transmitter.

tinuously, and since the screen-grid stage makes a very effective buffer, the frequency shift is negligible after the temperature of the tubes has reached a steady value. As in other oscillator-amplifier transmitters which are keyed in this fashion, a small key thump filter may be required so as not to cause local interference. However, this is an individual problem which must be solved for each and every station installation.

With the transmitter adjustments given for both 'phone and telegraph operation, some general considerations of the transmitter may be of use. The set, notwithstanding the fact that it uses receiving tubes exclusively, delivers a healthy "sock" to the antenna. The power output of this transmitter on 'phone exceeds that obtainable from a "100 per cent" modulated UX-210 preceded by a UX-865 buffer stage and crystal-controlled oscillator, the same modulator and plate supply being used. When it is considered that in the average amateur station no more power than that obtainable from one or two 210-type tubes is employed, the potentialities of this little rig assume no mean proportions. Moreover, the power

output of this transmitter is sufficient to swing the grids of a couple of 50-watt or UX-852 tubes arranged in push-pull as a linear amplifier. If desired, additional Class B amplifiers may be used to boost the output on C.W. Its ultimate power output need necessarily be limited only by the individual bank roll or the regulations imposed by the F.R.C. If one should wish to incorporate frequency doubling for telegraph transmission (and perhaps for 14,000-ke. phone, if and when that band should be made available) one or

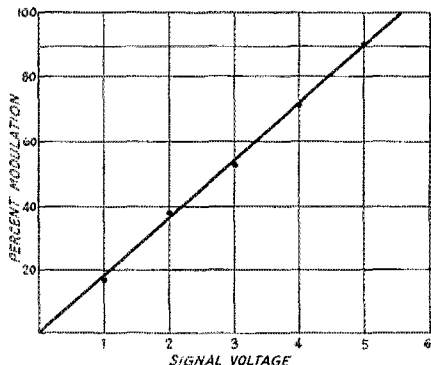

FIG. 4.—SPEECH AMPLIFIER INPUT-PERCENTAGE OF MODULATION CURVE FOR THE TRANSMITTER

two stages of additional screen-grid frequency doubling amplifiers may be interposed between the present buffer stage and the power amplifier.

POWER SUPPLY

No design data on power supply for the transmitter will be given, since practically every amateur has available suitable equipment to give the necessary plate and filament power as well as the required grid bias and screen-grid voltages. However, a few recommendations may be in order.

The plate power for the modulator and power amplifier tubes may be supplied by a 500-volt motor-generator set or rectified a.c. unit. In either case, a good filter should be used because smooth d.c. plate supply is essential to good quality transmission. This plate supply should be capable of delivering at least 100 milliamperes and should have good regulation. Plate power for the oscillator and buffer-amplifier may be derived from the 500-volt plate supply through proper resistances to drop the voltage to 180 or 200, but this method is generally unsatisfactory, and the use of a separate supply is recommended. The latter may be a 180-volt "B" battery substitute or 180 volts of heavy duty "B" batteries. The screen-grid voltage for the buffer-amplifier tubes can also be taken from this supply. The small size "B" batteries used for "C" bias on audio frequency

power amplifiers are entirely satisfactory as the source of grid bias, a total of 180 volts being required for phone operation or 90 volts bias for C.W.

Two filament supplies are required, one capable of delivering 1.25 amperes at 7.5 volts and the other 10 amperes at 2.5 volts. If the plate transformer happens to be equipped with a 7.5-volt winding, this may be used for the modulator tube filament supply. A center tapped filament transformer capable of delivering 10 amperes may be used as the filament and heater supply for the 2.5-volt tubes, one half of the secondary winding being employed and a rheostat provided in the primary circuit to drop the output voltage to not more than 2.5 volts.

A New Vernier Dial

THE increasingly exacting demand for accuracy in frequency measuring equipment is reflected in the new vernier scale 6-inch National Precision Velvet Vernier Dial, big brother to the 4-inch Type N version brought out some time ago. Increased dial diameter on the new type is accompanied by a proportionate increase in scale length of both the dial and vernier resulting in more facile readability.

In general, the 6-inch dial is similar to the Type N 4-inch one. The dial is of solid German silver with the divisions accurately cut on an engine divider. The mechanism is the original velvet vernier and the knob is of bakelite. Direct readings to 1/10 scale division can be made. As applied to a frequency meter having a frequency range of 500 kc., this means that direct readings to 1/2 kc. (500 cycles) are obtainable with a dial having 100 scale divisions for 180° of rotation.

A disc bakelite shield between the knob and the metal dial is provided to prevent the fingers from coming in contact with the metal.

The new dial should be particularly applicable to frequency meters, calibrated monitors, beat frequency oscillators and other equipment demanding accuracy of calibration and readability.

— J. J. L.

Strays

No necessity for kicking because your bug slides all over the table — use this suggestion furnished by W6NW, who got it from Mr. F. L. Dewey of the Mackay Radio Company, Los Angeles:

"Just moisten the feet on the bottom of the bug and press (the bug) down firmly on the table.

"It will then stick like a bum to a chicken sandwich, especially if the table is varnished or has a smooth surface of any kind. The moistening should be slight and done with the tip of the finger. If the rubber feet are not smooth enough, slide the feet of the bug over a fine piece of sandpaper first."

Notes on Ethereal Adornments

Practical Design Data for the Single-Wire-Fed Hertz Antenna

By L. G. Windom*

The use of the linear Hertz radiator fed by a single-wire line has been restricted in amateur work because of lack of data on its design and adjustment. This article explains how these systems may be completely designed on paper. The antenna may then be erected with the assurance that the voltage and current distribution on both the radiator and feeder will be correct. — EDITOR.

SOONER or later in the course of amateur development, one must have some sort of antenna, skyhook, or as you like it. In the earlier stages it consists generally of merely "a" antenna, then later after much deep (?) thought, it is "the" antenna. These few notes concern themselves only with that much-cursed atrocity, the single-wire-fed (cross-breed, voltage-current) Hertz. This type has the advantages of simplicity, ease of erection, very

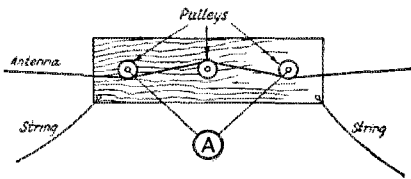

FIG. 1.—THE TROLLEY ARRANGEMENT USED TO PLOT THE CURRENT DISTRIBUTION ON THE RADIATOR

The same length of wire is maintained between the two outer pulley wheels which are connected to the ammeter. This effectively shunts the ammeter across a length of wire which causes a definite percentage of the current to flow through the meter. The position of the trolley is controlled by the two strings which allow it to be moved in either direction. Its position along the antenna during the tests described was determined by means of a transit.

high efficiency and, as will appear later, can be designed on paper and erected without the usual pruning operation.

The information herein contained is due to the efforts of John Byrne of the Bell Telephone Laboratories, exSLT, WSGZ, W8ZG, W8DKJ; Ed. Brooke, also of the Bell Telephone Laboratories, W2QV and exSDM; and Jack Ryder, W8DQZ, under the direction of Prof. W. L. Everitt of the Department of Electrical Engineering, Ohio State University. The writer acts solely as a reporter and all credit is due the above-named men.

Interest in the single-wire-fed Hertz antenna for amateur work started mainly with an article by Williams, 9BXQ, in the July, 1925, QST followed by several, others including the re-hash in

* W8GZ-W8ZG, 1575 Franklin Ave., Columbus, Ohio.

the July, 1926, issue. It is perhaps best to disregard all this previous material in relation to the

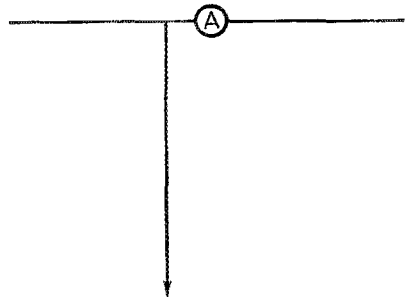

FIG. 2.—THE COMMONLY-USED METHOD OF DETERMINING THE FUNDAMENTAL OF THE ANTENNA IS TO INSERT AN AMMETER IN THE CENTER OF THE RADIATOR AND ADJUST FOR MAXIMUM CURRENT

This system is not satisfactory and the results obtained are very misleading.

single wire feeder system and start from the beginning.

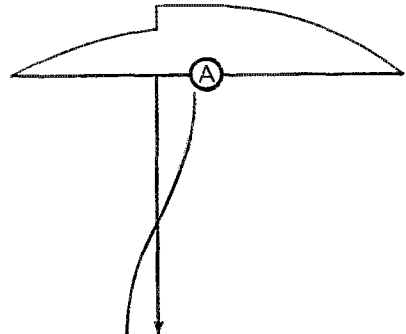

FIG. 3.—WHEN THE CURRENT IN THE CENTER OF THE RADIATOR WAS MAXIMUM IN THIS PARTICULAR CASE, THE CURRENT DISTRIBUTION WAS AS SHOWN

This is by no means a satisfactory condition, although it would be considered as such if only the ammeter readings were being considered.

Byrne and Brooke erected a special experimental station at W8XJ (Ohio State University),

consisting of a transmitter shack, a very stable oscillator and necessary ethereal equipment to vary the antenna in all possible ways. Measure-

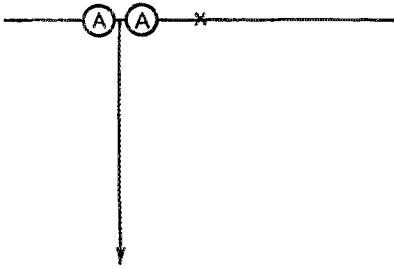

FIG. 4.—THIS SYSTEM OF DETERMINING THE FUNDAMENTAL EMPLOYS TWO AMMETERS PLACED CLOSE TO EACH OTHER WITH THE FEEDER CONNECTED AT THEIR JUNCTION

The ammeter normally located at the center of the system is dispensed with entirely.

ments were made by means of meters placed on trolley arrangements (Fig. 1) by which they were shunted across a portion of the antenna and readings taken at predetermined points through the aid of a transit.

A normal half-wave radiator with a single-wire feeder was erected, using a meter at the center of the radiator for tuning purposes, and with the feeder some 6 feet off the center as in Fig. 2.

Tuning for maximum current at the center of the antenna with this arrangement resulted in

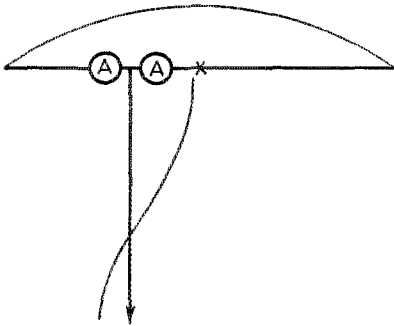

FIG. 5.—IN THE TEST WORK, THE TWO AMMETERS AND FEEDER WERE PLACED ON THE ANTENNA AT A RANDOM POINT AND THE TRANSMITTER FREQUENCY VARIED UNTIL THE READINGS OF THE AMMETERS WERE THE SAME

It was then found that the current distribution was as indicated.

a greatly distorted current curve on the antenna and a bad standing wave on the feeder as indicated in Fig. 3. Note that this is the usual method of tuning employed by amateur stations.

Obviously this wasn't according to the theory, so different lengths and feeder positions were tried—with the same discouraging results. Now let's write this on our cuffs or where you will—

the method of tuning a single feeder Hertz by means of an indicator at the center of the antenna is wrong and should not be used. True, there are some means of so doing, but they are more likely to lead one astray, even when you know what you are doing. From the above it was apparent that the first requirement was to hammer the current curve on the antenna into shape. Then, as says the movie sub-title, "came the dawn." Just where the glimmer came from I never knew, but most amateurs have a few spare ideas stored away somewhere. The meter in the center of the antenna was taken off and tossed into the lake—it wasn't their meter, so they could afford the procedure. Nevertheless, that step is essential to results—discard all indicators at the center of the antenna—the neighbors will feel better and the fire department will have fewer false alarms.

Next, two equal reading ammeters were placed in the antenna at a random point—any place between center and end—and the feeder connected between them as in Fig. 4. These meters should be as close together as possible. Also, one

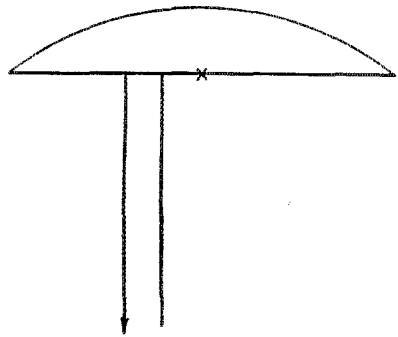

FIG. 6.—AFTER THE RADIATOR DIFFICULTIES HAD BEEN CLEARED UP, THE POSITION OF THE FEEDER WAS SHIFTED AND THE CURRENT DISTRIBUTION ALONG IT MEASURED

When the proper position was located, there were no standing waves upon the feeder and the radiator showed excellent current distribution as indicated. These conditions are independent of the length of the feed line which when properly adjusted will not cause any damaging radiation.

meter could be used by changing it from one side to the other of the feeder and plotting two frequency-vs.-current curves.

The transmitter was then tuned (frequency varied) until the two ammeters read exactly the same. The current curve of the antenna was again taken, and the result was a perfect current distribution as shown in Fig. 5.

Different lengths of antenna were tried and when adjusted by this method always gave a perfect current distribution curve. Such is only possible at the fundamental, hence this method is the proper one for determining the fundamental of a single feeder Hertz. A number of tests were run, and it was found that for the average ama-

teur antenna the fundamental was approximately 2.07 times the length in meters, i.e., $\lambda = L \times 2.07$.

Next the feeder was given a massage. Starting with it at the center, current curves were plotted (curves on the feeder) as it was moved outward. Again by the grace of the Wouff-Hong the standing wave on the feeder began to disappear. At a very definite point, the feeder curve became a straight line. Beyond this point standing waves again appeared. This procedure was repeated for a number of various antennas, and it was found that this magical position of the feeder from the center was a fixed ratio, and that, given any antenna length, we can compute the proper feeder point. This formula being: Distance of the feeder from the center equals the antenna length times

up to 1200 feet in length (that being the longest distance available) and that the only losses were those of resistance. The 1200-foot feeder had an

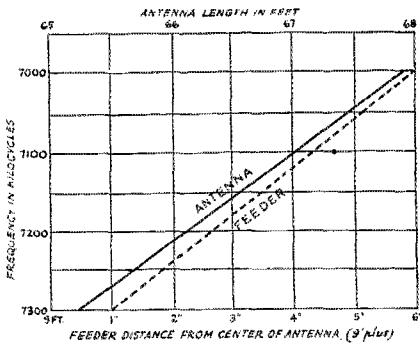

FIG. 7. — IN ORDER TO SIMPLIFY THE PROBLEM OF DESIGNING THIS TYPE OF SYSTEM, THE ABOVE CURVES ARE GIVEN

They cover the dimensions of the feeder and radiator for fundamental operation in the 7000-ke. band. One has but to decide upon the frequency at which operation is desired and then pick the values for feeder and radiator length directly from the chart. For the higher frequency bands, the radiator may be operated at a harmonic frequency; the feeder position will still be correct.

25 and the product divided by 180; i.e., feeder distance from center =

$$\frac{\text{Length of antenna (feet)} \times 25}{180}$$

These figures are for number 14 copper wire — the size having a slight effect — until for number 24 wire the factor 25 above becomes 30. The absolute factor for any size wire is thus easily computed. Also it was found that the position of the feeder has no effect on the fundamental of the antenna.

Recently at W8XJ, Ryder of WSDQZ has found that these formulas hold true for feeders

¹ This agrees quite closely with the figures obtained from a number of sources and given on page 49 of the October, 1928, issue of QST. Rearranging the formulas for the general problem of determining the length of wire in feet needed to give a certain fundamental wave length in meters, we get:

$$\text{Length in feet} = \frac{\text{Desired fundamental in meters} \times 1.56}{\text{Desired frequency in kilocycles}}$$

— Editor.

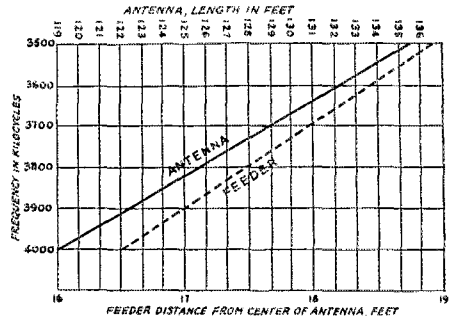

FIG. 8. — THESE CURVES ARE SIMILAR TO THOSE GIVEN IN FIG. 7 EXCEPT THAT THEY APPLY TO SYSTEMS HAVING THEIR FUNDAMENTAL FREQUENCIES IN THE 3500-KC. BAND

If a 14,000-ke. system is to be designed, these values may be divided by 4 or those given in Fig. 7 may be divided by 2.

efficiency of over 85%. Anyway, it isn't usual practice to put your antenna in the next state. Hence, we can say that the feeder length has no effect, for all normal operation.

Constructing an antenna by these two formulas and tuning to the predetermined fundamental by a good accurate frequency meter, we secure current distribution on the feeder and antenna as in Fig. 6, which is about as perfect as can be desired. The feeder efficiency for the average runs well over 95%.

Next, antennas for the 14,000- and 3500-ke. bands were tried and the formulas given found to hold true for all waves. A single feeder Hertz will work well at its harmonics — in fact just as well as at the fundamental, for the reason that the feeder connection will continue to be approximately at the correct distance from the voltage nodes. We can, therefore, build the antenna for the lowest frequency (highest wave) to be used and then work at harmonics for the other bands, or else use separate antennas. At W8XJ a 7000-ke. antenna has been working very effectively on 28,000 kc.

To save time and computation, graphs covering the 7000-ke. and the 3500-ke. band are given in Figs. 7 and 8. By choosing the frequency you desire to operate on, the antenna length and feeder positions are at hand. For a half-wave 14,000-ke. band antenna divide the figures of the 7000-ke. graph by 2.

The feeder is tapped directly on the plate inductance of the transmitter at such a point as causes the tube to draw normal input — i.e., the feeder tap is moved from the filament toward the plate end until the tube draws normal operating current. It is not advisable to push it out to the limit, as this tap on the inductance has an



The President's Corner

A WORD FROM
HIRAM PERCY MAXIM

PRESIDENT OF THE AMERICAN RADIO RELAY LEAGUE AND
OF THE INTERNATIONAL AMATEUR RADIO UNION

Lest We Forget

SOMETIMES I wonder if a good many of us A.R.R.L. people are not inclined to overlook big matters just because somebody talks a good deal about small matters. Every now and again somebody starts trying to pull apart our A.R.R.L. because Headquarters has done or has not done something or other.

Whose A.R.R.L. are they trying to pull apart? Is it Headquarters' A.R.R.L.? Not a bit of it. It is your and my A.R.R.L. and the other fellow's A.R.R.L. they are pulling apart.

Headquarters is our office, and it is occupied and run by those we hire and pay to run our affairs. You and I and the other fellow elect every so often our representative, to sit with the representatives that the rest of the country elects. These representatives are called Directors. They meet and agree upon what is best for Amateur Radio AS A WHOLE. When they have decided by majority vote, Headquarters is told what to do.

Now suppose something was decided that somebody does not like. Does it help very much to start pulling A.R.R.L. apart? Your Director and mine and the other fellow's had his say in the matter. All the other Directors heard him. The whole Board gave careful thought to the subject and voted. The majority vote prevailed, as it should.

Consider our country itself. When we elect a Congress of these United States, we discuss and argue and study and then vote. The representatives and senators getting the most votes are elected. Then, when these representatives and senators go and decide something you do not like, do you start trying to pull apart the United States? Not at all. Our U. S. A. would not be where it is if we did.

When election comes around again you vote for a different representative or senator. If a majority of the rest of your fellow citizens think as you do, a different representative or senator is elected. BUT, if you are in the minority, they return the same representative or senator. That is majority rule. You are obviously on the wrong side of the fence.

In certain foreign countries they start pulling their government apart when an election does not go their way. There are all kinds of factions. But this is the U. S. A. and we do not run our affairs that way.

Have you ever stopped to think what the effect would be were we radio amateurs to adopt these other methods? We would have some twenty or thirty different warring amateur radio organizations all shouting at each other, calling each other names and demanding different things. What do you suppose our authorities would do under the circumstances? How far would Amateur Radio get?

effect on the efficiency of the transmitter beyond a certain point. In addition, you can spoil a good note by such excessive coupling. The formulas are for average operation using inductances about 4 inches in diameter. For 28,000 and 14,000 kc., one turn from the filament; for 7000 kc., two or

three turns; and for 3500 kc., five or six turns are ample, depending, of course, on the total number of turns used. A ground should be used on the filament circuit as a protective measure.

As a summary, the following steps should be

(Continued on page 84)

“XYL”

By Eulalia M. Thomas*

IT has been requested by the powers-that-be at *QST* factory, that the operator at WSCNO write an article under the caption of, “Impressions of ham radio by an XYL operator, especially those concerning the idiosyncrasies of the male of the species.” Here goes, then, under protest.

Ever since WSCNO has been on the air, two years in May, my original expression of classifying myself as an “XYL” has been a stumbling block to many, and I take this opportunity of explaining the same. “XYL” means just what it says, i.e., ex-YL, which means that I am no longer exactly a YL operator, nor yet can I be classed as an OW. Not wishing to sail under false colors, “XYL” was originated. Very few guesses as to its meaning are correct, which may not indicate an over-abundant amount of intelligence on the part of the male of the species! Some have even hazarded that it might mean “old maid.” Horrors! That decidedly is not the case; nor is it a nice way to get around “OW.” Others have given the “X” the algebraic meaning “unknown.” It has been amusing to note how some of them try to ignore the “XYL” part until their curiosity eventually gets the best of them! I hereby swear, under oath, that I am not a spinster, nor an old woman, and not a YL either — so there!

How did I get into the game? There are various absurd reasons, but being especially requested to do so, I will tell you the chief one. A great admiration for the achievements of Donald MacMillan and the fact that he was using the higher frequencies for communication led me first into the field of ham radio from which field I find it very difficult to stray.

In the summer of 1925 I read in a daily paper how one could build a radio set for ten dollars on which one could hear MacMillan broadcast. I didn't even know I would have to learn the code and, when that astounding fact was announced, I gave up all hope. The following summer, ex-W8DED became my neighbor. One night I was trying hard to distinguish a dot from a dash, and suddenly W8DED began to copy. “We are now off the coast of Disko — etc. — signed MacMillan.” Well, that settled it! I would follow MacMillan into the far North. I would master code! By the next summer I had my license and was operating. Just to hear WNP was not enough. I have called him often, but in vain. I have not given up hope, and some night

my dream will be fully realized in a two-way communication with the *Bowdoin*.

Which phase of the game do I enjoy the most? Well, I've had my fling at all of them except experimenting, as most hams know it, and from the lot it is very hard to choose. A good rag-chew is a joy when I have time, which is not often. I have had plenty of thrills out of DX and of it



THE “XYL”

I have had my share, so they say, but yet I am not contented. I am enough of a DX hound to hunger for more whenever the opportunity presents itself. I hope sometime to tack “WAC” on my wall. Then, and only then, will I be content with my DX.

Swapping signals never interested me much; but traffic! That holds me and interests me much and constantly. I am more or less known (and cussed) for usually getting what I go after, and a growing pile of legitimate messages handled is a sign of achievement to me. Therefore I may say with all truthfulness that the traffic phase interests me most of all. Let me add here that the fellows in the traffic game are the cream of the gang and far too busy with message handling to find time to develop some of the idiosyncrasies which I shall mention later. They treat me as one of them and that's what I want.

What has been my greatest thrill in radio? Well, that again, is hard to decide, for I've had many — but, to me, this one is outstanding. I had been up all night DXing with fair success. Yes, I “boil the owl”; what DX hound does not? About four a.m., I came upon a faint “CQ.” I answered and we went through the usual blah, “DC — R3 — conditions OK — QRA Delaware, Ohio — etc.”

* (Mrs.) WSCNO, 71 Griswold Street, Delaware, Ohio.

Back came the question, "Did you say Delaware, OHIO? Do you know Lydia Crickard? She is a friend of mine." Know her! She lives but two blocks away, and was my teacher at one time. I think K6DQQ was as excited as I. To think of all the amateurs in this big old world, I should pick out of the air a friend of my former teacher! As he signed off giving me "73," I knew Miss Crickard and I had a mutual friend in far-off Wailuku.

To me, one of the greatest things in amateur radio is the friendships one forms. Ofttimes there is naught but the thinnest strands of communication binding them. It is as the poet Dix has said, "My world is as wide as the realm of thought."

(Continued on page 72)

ELECTION NOTICES

To all A.R.R.L. Members residing in the ATLANTIC, DAKOTA, DELTA, MIDWEST, PACIFIC (including Territory of Hawaii and Philippine Ids.), and SOUTHEASTERN (including Porto Rico, the Republic of Cuba and Isle of Pines) Divisions of A.R.R.L.:

1. You are hereby notified that an election for an A.R.R.L. Director, for the term 1930-1931, is about to be held in each of the above Divisions, in accordance with the Constitution. Your attention is invited to Sec. 1 of Article IV of the Constitution, providing for the government of A.R.R.L. affairs by a Board of Directors; Sec. 2 of Article IV, defining their eligibility; and By-Laws 9 to 18 providing for their nomination and election. Copy of the Constitution and By-Laws will be mailed any member upon request.

2. The election will take place during the month of November, 1929, on ballots which will be mailed from Headquarters in the first week of that month. The ballots for each Division will list the names of all eligible candidates nominated for the position by A.R.R.L. members residing in that Division.

3. Nominating petitions are hereby solicited. Ten or more A.R.R.L. members residing in any one Division have the privilege of nominating any member of the League in that Division as a candidate for Director therefrom. The following form for nomination is suggested:

(Place and date)

*Executive Committee,
American Radio Relay League,
Hartford, Conn.*

Gentlemen:

We, the undersigned members of the A.R.R.L. residing in the Division, hereby

nominate, of, as a candidate for Director for this Division for the 1930-1931 term.

(Signatures and addresses)

The signers must be League members in good standing. The nominee must be a League member in good standing and must be without commercial radio connections. His complete name and address should be given. All such petitions must be filed at the headquarters office of the League in Hartford, Conn., by noon of the first day of November, 1929. There is no limit on the number of petitions that may be filed, but no member shall append his signature to more than one such petition.

4. Present Directors from these Divisions are as follows: Atlantic, Prof. Eugene C. Woodruff, State College, Pa.; Dakota, Prof. C. M. Jansky, jr., Minneapolis; Delta, Mr. Benj. F. Painter, Chattanooga; Midwest, Mr. Porter H. Quinby, St. Louis; Pacific, Mr. Allen H. Babcock, San Francisco; Southeastern, Mr. Harry F. Dobbs, Atlanta. Members of the Southeastern Division are informed that no nominations were filed from that Division in the elections of 1927, in default of which Mr. Dobbs has remained in office.

5. These elections are the constitutional opportunity for members to put the man of their choice in office as the representative of their Division. Members are urged to take the initiative and file nominating petitions immediately.

For the Board of Directors:

K. B. WARNER, Secretary.

Hartford, Conn., 1 August 1929.

To all A.R.R.L. Members residing in the Dominion of Canada, Newfoundland, and Labrador:

1. You are hereby notified that an election for an A.R.R.L. Canadian General Manager, for the term 1930-1931, is about to be held, in accordance with the Constitution. Your attention is invited to By-Law 28, defining the policy of the League in Canada; Sec. 1 of Article IV of the Constitution, providing for the government of A.R.R.L. affairs by a Board of Directors, of which the Canadian General Manager is a member; Sec. 2 of Article IV, defining the eligibility of Directors; By-Laws 25 and 26, specifying the duties and authority of the Canadian General Manager; and By-Laws 22, 23 and 24, providing for his nomination and election. Copy of the Constitution and By-Laws will be mailed any member upon request.

2. The election will take place during the month of November, 1929, on ballots which will be mailed from Headquarters in the first week of that month. The ballot will list the names of all

(Continued on page 70)

Improving the All-Purpose Super-Heterodyne

By L. W. Hatry*

ANY designer or builder of a high-frequency super-heterodyne must reckon with a major fault of the breed, the interlocking of tuning controls effected by coupling between the oscillator and first detector. This manifests itself in two ways. Detector tuning is as critical as oscillator tuning, and several combinations of tuning condenser settings for the same station can be obtained. The former is annoying, since two dials must be carefully adjusted, but the latter makes for insane confusion as no calibration can be considered as such if it is always contradicted by finding the dial readings for the same station at, say, 15°-15°, 20°-10°, or 25°-0°, etc. Now interlocking, even with its effect on calibration, could be ignored if the wrong

if interlocking is to be limited and sensitivity maintained. Because of the need for a less critical

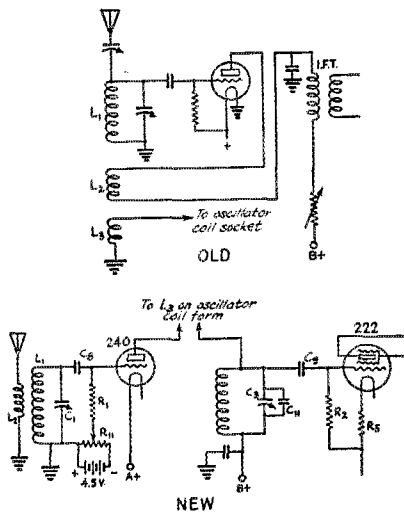

FIG. 1.—THE ORIGINAL AND MODIFIED VERSIONS OF THE FIRST DETECTOR CIRCUIT

The top diagram is that of the first detector circuit of the original set while the lower diagram illustrates the changes suggested in the text.

settings gave noticeably weaker signals, but it often has no effect on signal strength, with the result that the right setting is as much a stranger as a non-microphonic 201-A.

In the QST all-purpose super-heterodyne, a type of oscillator-detector coupling is used which generally proves noticeably critical in adjustment

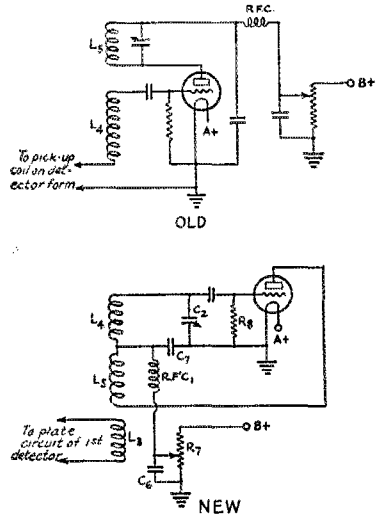

FIG. 2.—THE ORIGINAL AND MODIFIED OSCILLATOR CIRCUITS

pick-up causing less interlocking, a number of tests were made toward that end. These tests resulted in an improved pick-up arrangement as well as two other improvements which came from two additional changes.

These three improvements call for several changes in a set made according to the article in QST for March, 1929, but these changes are minor and can be made easily so far as the circuit is concerned. The improvements cover an oscillator pick-up which even when over-abundant is quite useful; the elimination of first detector regeneration and consequently of a control; and greater overall sensitivity obtained partly from the use of a 240-type high-mu tube as first detector, partly from the use of abundant pick-up which is not damaging under the new conditions and partly from properly biasing the first detector.

In addition to the circuit changes required to accomplish these things one other change is recommended, a change that has been recommended previously in QST, the addition of a volume control. If the owner of the set is interested chiefly in

* Hatry & Young, Inc., 126 Ann St., Hartford, Conn.

broadcasting, or sufficiently in broadcasting, his volume control must be placed where it will prevent the second detector or audio tubes from overloading. A control satisfactory for this purpose consists of a potentiometer to adjust the

detector sensitivity noticeably and, incidentally biases the tube for plate rectification. The first detector bias could, with a saving of apparatus, be run through the inductance of the tuned circuit, but I found the arrangement shown an easier means of changing over a ready-made set. The chap starting at scratch should omit the grid-leak and condenser, but he will probably find the potentiometer desirable for getting exactly the right bias. It should be by-passed when in the filament return.

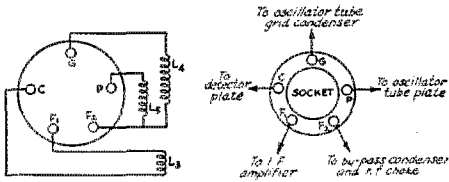

FIG. 3. — CONTACT AND SOCKET CONNECTIONS FOR THE OSCILLATOR COIL

voltage on the screens of the r. f. tubes. The chap interested chiefly in C. W. and headset reception, however, needs his volume control after the second detector, since second detector oscillation manifests itself as a hiss and the hiss should not be reduced while the signal level is lowered. If one wants both types of reception, both controls should be provided, the one to prevent distortion and the other to prevent ear fatigue and maintain the signal-noise ratio.

THE CHANGES

In relation to the original circuit the changes required for the improvements group themselves as follows:

1. First detector circuit and coils.
2. Oscillator circuit and coils.
3. First r.f. transformer construction.
4. Screen-grid wiring or first audio wiring.

The first detector when changed has no tickler, and since the pick-up is in series with its plate circuit the detector coils will need but one winding, that for the tuned circuit. Pick-up coil and tickler are omitted. This results in leaving three of the five coil-form prongs unused and suggests an additional change and another desirable gain, and two of them. This addition is of an antenna coil or primary on each coil which would eliminate C_1 and the changes in calibration it can cause, since every change in C_1 affects the capacity setting of C_2 for a given frequency. As C_1 is decidedly too small for the broadcast and 2000-kc. bands, and causes a loss in sensitivity, the addition of an antenna coupling coil is a very noticeable gain.

Fig. 1 shows the first detector changes schematically and also shows the original first detector circuit for comparison. Notice that the high- μ tube is impedance-coupled to the first intermediate frequency amplifier. Also notice that the grid-leak gets the grid-return through a potentiometer of 500,000 ohms (to be mounted on the baseboard and set but once as it does not need constant adjustment) which bridges the 4.5-volt "C" battery. This connection increases first

THE OSCILLATOR

The oscillator suffers circuit changes as radical as and more complete than those imposed on the first detector. These changes are most noticeable on the coils, being minor in the wiring. They are shown in Fig. 2. Whether grid or plate tuning is used is unimportant and makes practically no difference in the coils or results. Grid tuning is shown in Fig. 2 because I happen to have used it in a finished set embodying the improvements mentioned. The connections of the oscillator coil windings to the pins on the coil forms are shown

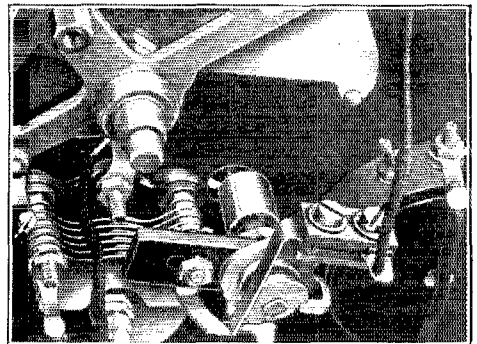

A LOW CAPACITY SWITCH FOR CONNECTING THE MIDGET HIGH FREQUENCY TUNING CONDENSER IN PARALLEL WITH THE 300- μ fd. VARIABLE FOR OPERATION IN THE BROADCAST BAND

A Yazley battery switch is used, the stationary blade being removed and mounted directly on the back of the midget condenser as shown. A strip of hard rubber is mounted on the same bolt of the midget and supports the switch. A National shaft extension goes through the panel to the control knob.

in Fig. 3. Of course, these may be departed from whenever one desires. The oscillator grid leak should be 25,000 ohms, as such a low resistance makes the size of L_b , the plate (or if tuned-plate, the grid) coil, less critical and assures one of a full oscillator tuning range without squealing. However, with the 25,000-ohm leak one can have so much feed-back that the result is an a.f. howl or a number of beat notes independent of signals if the "B" voltage is set too high.

The first intermediate frequency transformer construction was mentioned as being changed. The change is simply in the elimination of the separate primary. Anyone wanting to use a

separate primary should wind a wad of about 300 turns for it.

The change in the wiring to the screen-grids for the insertion of a volume control is shown in

If one has satisfactory oscillator coils they will very likely require no change in turns, but only in terminations, and since the additional turns of the pick-up are few and have

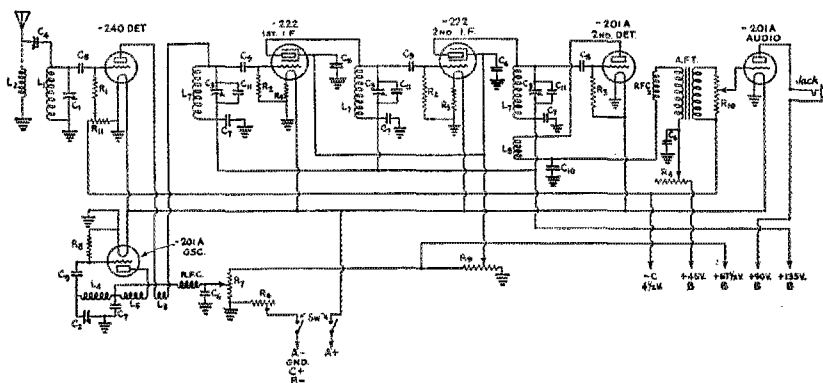

FIG. 4.— THE COMPLETE DIAGRAM OF THE MODIFIED CIRCUIT

- L_1, L_2 —Detector coils. (DA, DB, DC, etc.)
- L_3, L_4, L_5 —Oscillator coils. (OA, OB, OC, etc.)
- L_1 —Intermediate Amplifier Inductance. See March, 1929, QST for details.
- L_3 —15 turns of No. 30 d.s.c. wire wound over L_1 at B + end.
- RFC_1 —Silver-Marshall No. 277 or Remler radio-frequency choke.
- RFC_2 —Silver-Marshall No. 277 or Hammarlund 85 millihenry r. f. choke.
- C_1 —13-plate Pilot midjet condenser or duplicate of C_2 .
- C_2 —ET-27 National double section variable condenser.
- C_3 —23-plate Pilot midjet or Hammarlund 100- μ fd. Equalizer.
- C_4 —5-plate Pilot midjet condenser. Omitted when L_2 is used.
- C_5 —Omitted.
- C_6 —1- μ fd. by-pass condenser.
- C_7 —0.25- μ fd. Sprague fixed condenser.

- C_8 —250- μ fd. fixed condenser.
- C_9 —600- μ fd. fixed condenser.
- C_{10} —1,000- μ fd. if RFC_2 is 85 m.h. 4,000 μ fd. if RFC_2 is SM 277
- C_{11} —100- μ fd. fixed condenser.
- R_1 —5-megohm grid-leak. This value not critical.
- R_2 —2-megohm grid-leak.
- R_3 —5-megohm grid-leak.
- R_4 —50,000-ohm ElectroRad Royalty variable resistor.
- R_5 —15-ohm fixed filament resistors.
- R_6 —2-ohm rheostat.
- R_7 —100,000-ohm ElectroRad Royalty resistor.
- R_8 —25,000-ohm grid-leak.
- R_9 —50,000-ohm Yaxley potentiometer.
- R_{10} —200,000-ohm ElectroRad Royalty resistor.
- R_{11} —500,000-ohm ElectroRad Royalty potentiometer.

The designations correspond in general with those of the circuit diagram on page 13 of QST for March, 1929.

the complete diagram, Fig. 4. This results in satisfactory control even on very strong local signals. And the reader will find that the complete diagram also shows, in addition, the wiring change for the proper kind of volume control for the high frequency telegrapher.

practically no effect upon tuning range, they can be added to the oscillator coil form without

THE COILS AND THEIR WINDING

The table of coils included with this is correct for a set using two double-section National "ET-27" variable condensers, one for oscillator and one for first detector; but, nevertheless, may not be exactly right for your particular set operated under those same physical conditions. The National "ET-27," incidentally, is a factory-made double-section variable with the specifications given in March QST.

The table is correct only if the coils are made as Fig. 5 indicates on Pilot coil forms. An increase of less than 50% in the spacings recommended causes small change.

COIL DATA

	L_3	L_4	L_5	Wire Size, L_1	L_1	L_2	Wire Size, L_1
OA	1	5	5	No. 22, d.s.c.	DA	6	0
OB	1	7	6	"	DB	8	"
OC	2	8	6	"	DC	9	"
OD	2½	12	8	"	DD	13	"
OE	3	17	8	"	DE	18	"
OF	4	22	10	"	DF	22	"
OG	4	30	14	"	DG	31	"
OH	15	35	25	No. 30, d.s.c.	DH	50	"
OI	15	45	35	"	DI	75	20
OJ	1	5	8	No. 22, d.s.c.			
OK	1	1½	5	"			

OJ and OK are special oscillator coils for the 7000- and 14,000-ke. bands and are made up as shown in Fig. 7. This table corresponds in general with the frequency ranges for corresponding coils in the table accompanying the article in March, 1929, QST, describing the original super-heterodyne.

damage. If the coils are wound on S-M forms from the table accompanying this article they will differ slightly but not harmfully in frequency range, the range generally being slightly lower;

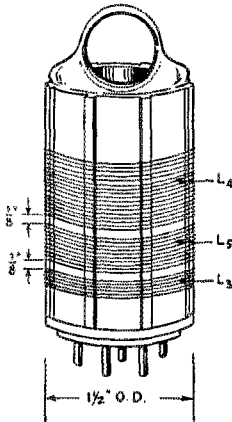

FIG. 5.—ARRANGEMENT AND SPACING OF THE OSCILLATOR COIL WINDINGS

e.g., OG becomes 3300 to 3200 kc. This change will seldom be enough to impair usefulness or require correction.

ADJUSTING COILS

Adjusting the antenna coil is so simple that I have no suggestions. Each of us has preferences regarding frequency ranges. The table, consequently, is merely a guide, not a dogmatism. Also one need not adhere to the small capacity of ap-

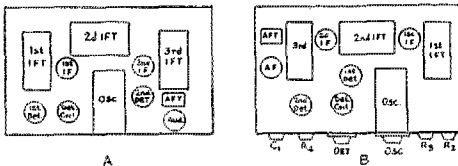

FIG. 6.—ARRANGEMENT OF THE APPARATUS IN THE ORIGINAL AND MODIFIED SETS

proximately 42 μ fd. for high-frequency tuning; reasonably larger capacities simply increase tuning criticalness and frequency range without other material harm.

The oscillator coil is a more complicated matter. If the tickler or plate coil has too many turns the oscillator will howl when the "B" voltage to it is too high; but it will work satisfactorily at some voltage within the range of R_7 , this range becoming increasingly narrow as the turns on the tickler increase. Consequently the tickler coil adjustments need not be made to a critical point, but only to that which allows some convenience of handling; for instance, if howling starts at not more than the last one-third of the movement of

R_7 's knob, the previous full third will be the useful operating range. However, one can get rid of oscillator howling and half a turn of R_7 for merely controlling the strength of oscillation. The howling must be avoided because the consequence is no signal.

The pick-up perhaps is best explained by contrast. The method of pick-up shown in the March QST is hard to adjust because the amount of

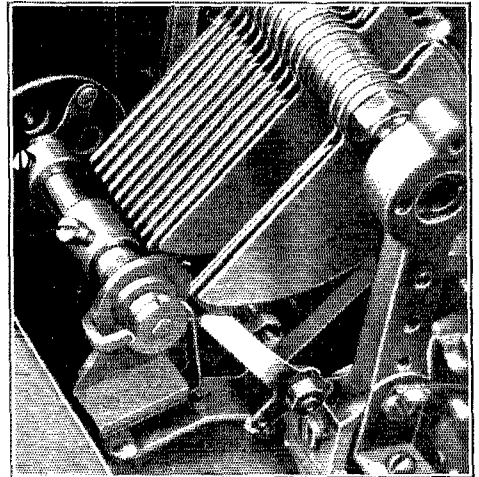

THE SWITCHING ARRANGEMENT EMPLOYED IN CONNECTION WITH THE DOUBLE-SECTION NATIONAL CONDENSER

The stator blade is mounted on the stator of the low capacity section of the tuning condenser. Closing the switch cuts the three-plate section of the condenser in parallel with the high capacity section for broadcast band tuning. For high-frequency reception the three-plate section only is used.

winding in L_3 varies with different sets and is critical unless one can put up with the horrors of interlocking tuning. For instance, I have built several sets in duplication of that described, and all have required pick-up turns on DA, DB and DC. That on DA has varied from a quarter to a full turn; a quarter of a turn making the difference between confusing interlocking and somewhat less interlocking with sufficient sensitivity. With this coil no size of pick-up not sacrificing sensitivity would eliminate an annoying amount of interlocking. The reason is plain. The oscillator and detector are only 2% off common resonance. Even on DD, at 7500 kc., with the difference increased to 4%, L_3 when small enough to reduce interlocking decreased sensitivity too greatly, and it had to be adjusted to the quarter turn. Such adjustments are tedious and not entirely necessary, nor is a loss of sensitivity essential.

The pick-up diagrammed in Figs. 1 and 2 is not so critical of adjustment or so harmful if oversized. Besides, even when so large as to cause very noticeable interlocking, the erroneous settings are apparent because of somewhat reduced volume.

(Continued on page 82)

Vacuum Tube Amplifier Definitions

By H. F. Dart and C. K. Atwater*

There has been a considerable amount of mystery surrounding the various classifications of amplifiers. We have heard amateurs glibly speaking of Class A, B and C amplifiers without having any realization whatever of the characteristics of these arrangements. We are, therefore, pleased to be able to present the following material which should help considerably in clearing up the matter. These definitions have been arrived at jointly by the General Electric and Westinghouse companies. — EDITOR.

VACUUM tube amplifiers are used in many different types of equipment and under widely varying conditions. Fundamentally, the characteristics of operation fall into general classes depending upon the main features of grid bias, excitation, distortion and other factors. The operating conditions may be divided into three general classes: namely, the usual type of audio-frequency amplifier called Class "A"; a more or less limited class of radio-frequency amplifier called Class "B"; and the usual type of oscillator or radio-frequency amplifier specified as Class "C." The definition of each class is indicated and later described in detail.

CLASS A — VOLTAGE OR POWER AMPLIFIER OR MODULATOR

"The Class A amplifier operates so that the plate output wave shapes are essentially the same as those of the exciting grid voltage.

"This is accomplished by operating with a negative grid bias such that some plate current flows at all times, and by applying such an alternating voltage to the grid that the dynamic operating characteristics are essentially linear. The grid must usually not go positive on excitation peaks and the plate current must not fall low enough at its minimum to cause distortion due to curvature of the characteristic.

"The amount of second harmonic present in the output wave which was not present in the input wave is generally taken as a measure of distortion, the usual limit being 5%.

"The characteristics produced are low efficiency and output with a large ratio of power amplification."

The Class A amplifier is the usual type of audio-frequency amplifier and operates with very little distortion. The recommended operating conditions are such that the tube can operate with a considerable grid swing and without the introduction of an appreciable amount of distortion in the output which was not present in the input. Grid bias is secured from a separate source to keep the plate current at the desired value. The

* Both of Westinghouse Lamp Company, Bloomfield, N. J.

grid bias should permit the plate current to swing over the essentially straight portion of its characteristic curve when excitation is applied. The grid bias should be so selected that the grid swings in a positive direction will not cause the grid to take current while equal excitation in the

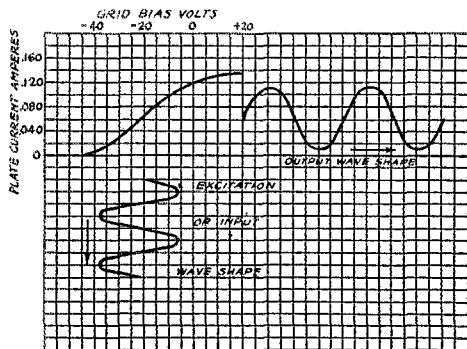

FIG. 1— CLASS A AMPLIFIER

opposite direction will not cause distortion due to curvature of the plate characteristic curve.

A characteristic curve is illustrated in Fig. 1 as a theoretical example. If the grid bias is extended to 45 volts negative, the plate current will be reduced to zero, while if the grid bias is reduced to zero, the plate current goes to approximately 120 milliamperes. If a signal of 16 volts is applied to the grid with the grid bias as indicated of -22 volts, it will vary the plate current between the limits of 10 and 110 milliamperes. The output wave indicated at the right of the figure represents the current in the plate circuit. As seen by inspection, the wave shape of the output is practically the same as that of the excitation or input wave. A typical circuit is indicated in Fig. 2.

This type of amplifier produces an output which follows the characteristics of the input very closely, but the efficiency is not so high as that obtainable by some other methods.

As a Heising or constant plate current modulator, the operating characteristics are practically the same as those obtainable with the usual type of audio amplifier. In fact the modulator tube

acts as an audio-frequency amplifier, except that its output is super-imposed onto a radio-frequency carrier wave, rather than fed into a loud speaker.

CLASS B — RADIO-FREQUENCY POWER AMPLIFIER; BALANCED OR PUSH-PULL MODULATOR

“The Class B amplifier operates so that the power output is proportional to the square of the excitation grid voltage.

“This is accomplished by operating with a negative grid bias such that the plate current is practically zero with no excitation and by apply-

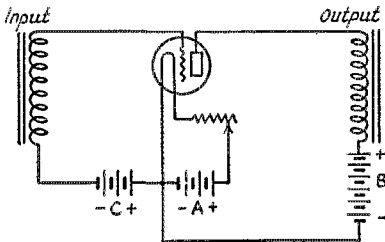

FIG 2

ing excitation grid voltage such that essentially half sine-waves of plate current are produced on the least negative half cycle of the grid voltage. The grid may usually go positive on excitation peaks, the harmonics being removed from the output by suitable means.

“The characteristics produced are medium efficiency and output, with a relatively low ratio of power amplification.”

This type of amplifier is used chiefly in the amplifier stages of transmitters in which modulation is effected in a low-power stage. The radio-frequency signal from this modulated stage carries the audio-frequency component and must be sent through a special amplifier, as any second harmonic or other distortion would be carried through to the receiving set and cause objectionable distortion in the signal. Therefore, the succeeding radio-frequency stages, including the output stage must amplify the signal without introducing appreciable audio-frequency changes. In other words, the characteristics of the output wave of any one stage should correspond as closely as possible with the input to that stage. The distortion may be reduced to some extent by an output tank circuit of suitable design (for instance with high capacity), or by push-pull amplifier circuit connections. The tubes in an amplifier of this type are usually operated with enough grid bias to reduce the plate current to slightly above cut-off value. The excitation is strong enough to swing the grid somewhat positive and thus produce an appreciable rectified grid current. Rather heavy loads are placed on the preceding amplifier by the large amount of

grid excitation required to overcome the grid losses in the tube.

The output efficiency is very good due to the fact that the grid swings positive for part of the cycle. Also the heating of the plate is very uniform under these operating conditions. The plate dissipation ratings recommended for radio-frequency operation apply to this class of service.

As indicated in Fig. 3, the grid bias may come close to the plate current cut-off value of -45 volts. With an excitation of, say, 65 volts, the grid will swing slightly positive. The output wave shape will be practically half sine-waves of plate current which, however, are flattened to some extent at their peaks. By using two similar tubes in push-pull, a very good output wave shape can be secured, particularly when a tank circuit of suitable design is used.

Although the circuit of Fig. 2 may be used, the tuned-grid and plate circuits represented in Fig. 4 are usually more suitable. The grid bias may be secured from a “C” battery or a generator. A grid leak is not suitable as its use would tend to produce distortion.

CLASS C — RADIO-FREQUENCY POWER AMPLIFIER OR OSCILLATOR

“The Class C amplifier is one in which the output is the primary consideration. The output varies as the square of the plate voltage, within limits.

“This is accomplished by operating with a negative grid bias of more than a sufficient value to reduce the plate current to zero with no excitation. An alternating grid excitation is applied such that large amplitudes of plate current are passed during a fraction of the least negative half cycle of the grid excitation voltage. The grid voltage usually swings sufficiently positive to

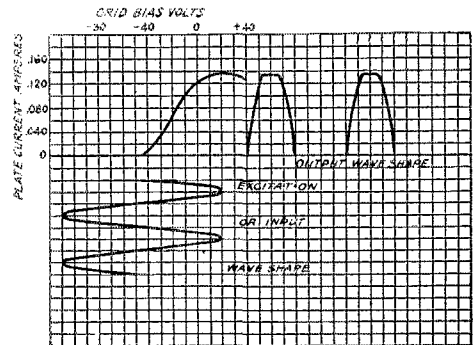

FIG 3—CLASS B AMPLIFIER

allow saturation plate current to flow through the tube. Thus the plate output waves are not free of harmonics, and suitable means are usually provided to remove harmonics from the output.

“The characteristics produced are high effi-

ciency and output, with a relatively low ratio of power amplification."

The Class C radio-frequency service corresponds with the usual type of oscillator and radio-frequency amplifier. The tube operates with a negative grid bias considerably more than enough to produce plate current cut-off. The excitation peak voltages must be sufficient to drive the grid considerably positive in order to secure large amplitudes of plate current. This results in very high efficiency of tube operation due to the fact that the tube's internal resistance is very low under these conditions. However, the grid excitation losses are relatively high and the preceding stage must deliver enough energy to supply these losses. In fact, the grid excitation goes so far positive that saturation may be reached for a relatively large portion of the cycle.

The tube operates so that a considerable amount of second harmonic distortion is produced with the positive grid swings. However, the plate output circuit is usually provided with a tuned tank circuit designed so the distortion is reduced by a considerable amount and practically all of the second harmonic distortion is eliminated. In most cases, the distortion is not objectionable, as the radio-frequency current acts merely as a carrier agent between the transmitter and receiver and is removed from the signal in the detector tube of the receiving set. Thus any radio-frequency distortion of this type does not impair the quality of the signal.

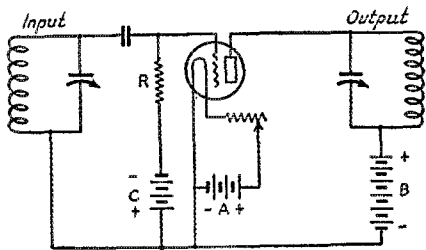

FIG. 4

The circuit of Fig. 4 also represents the connections of a typical amplifier of the Class C type. The input circuit is tuned and is connected to the grid of the tube through a suitable blocking condenser. The output circuit is tuned to the input frequency and is in turn coupled with the desired succeeding amplifier or the antenna system.

The negative grid bias may be secured from a generator or from the drop in voltage produced by the rectified grid current flowing through the grid leak, *R*. Also a combination may be used with the generator supplying a large proportion of the bias and a grid leak supplying the remaining amount required by the operating conditions. The value of grid bias is usually not critical.

When a grid leak is used, the grid bias depends

upon the voltage drop produced by the rectified d.c. grid current flowing through the grid leak. The bias will thus depend upon the value of the

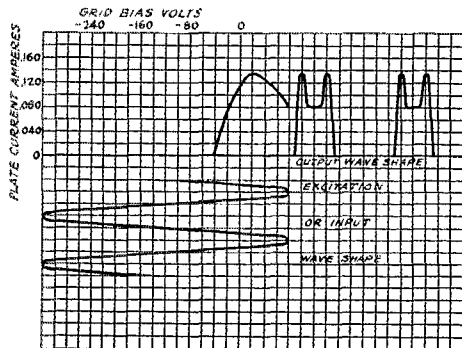

FIG. 5 - CLASS C AMPLIFIER

grid resistance and upon the rectified grid current. In case the excitation becomes stronger, the rectified grid current becomes greater and the grid bias increases. In this manner the grid leak method of securing a grid bias is very effective over a wide range of operating conditions. In case a generator or a "C" battery is used, it is common practice to employ some grid resistance to take care of circuit and other variations.

Due to the large proportion of the time that the grid is positive, the efficiency is very high.

As indicated by Fig. 5, the grid bias may be roughly -120 volts and with a peak excitation signal of 200 volts, the grid is driven so far positive that the plate current is appreciably reduced on the excitation peaks. The increasing plate current rises rapidly to its maximum value, dips and then rises for a portion of the half cycle and later rapidly drops to zero, producing what is frequently referred to as a "square" wave shape. The tank circuit usually presents a considerable "fly wheel" effect so that the signal is radiated as a wave showing only relatively unimportant amounts of distortion.

Doings at Headquarters

SUMMER is here which means that those of us at Headquarters who are not already vacationing are at least looking forward to our few days at the sea-shore, in the mountains or painting the house.

During July we were visited by several amateurs. Fred Elser of old-time op3AA and xop1ZA was down for a chat one afternoon. Fred is located at Cambridge at present while studying at M. I. T. Mr. and Mrs. W8KC of Cleveland dropped in on us one afternoon, as did Middleton and Lister of the same city. W3AID and W3CGS of Philadelphia drove up one day. W3MQ of Allentown, Pa., paid us a short visit. W4AZ of

(Continued on page 70)

W9CJC

This is the fifth published entry in the Station Description Contest held to determine which amateur station conforms most nearly to 1929 standards. We are sure that there are many stations worthy of appearing in these columns, although relatively few amateurs have sent in descriptions of their stations. The closing date for this contest is October 10, 1929. If your station is worthy of space in this contest, be sure that your description reaches us by October 10. — EDITOR.

W9CJC, owned and operated by E. H. Carter, 3455 Elizabeth Street, Denver, Colo, first came on the air with a tuned-grid tuned-plate transmitter using two UX-210 tubes before the days of "high C" and 1929 regulations. The transmitter was changed slightly to make it a fairly high-C oscillator circuit when it became evident that

pany amateur frequency meters. The old equipment used in 1928 is still retained, and may be pressed into service for emergency use if necessary. The general layout of the station is shown below. In designing the crystal-controlled transmitter for 1929 operation, UX-210 tubes were chosen because of their low initial first cost, their low up-keep cost and their adaptability.

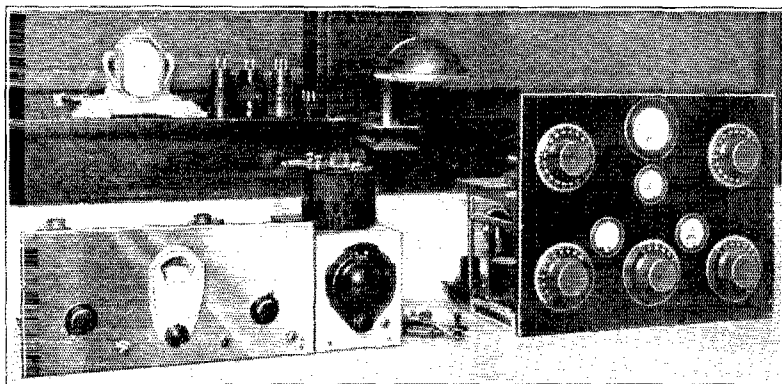

A GENERAL VIEW OF W9CJC

Note the absence of unnecessary apparatus.

the restricted regulations would require more careful operation and better constructional practices. Modulation due to a ripple in the plate supply caused a rather broad wave to be emitted, which was quite effective in covering up any frequency drift which occurred as the oscillator tube became warm. A filter in the generator smoothed out the note, and further improvements, principally in reducing the L/C ratio so as to provide a still higher C circuit, cured creeping, and some very good results began to be obtained. However, it was believed that better results could be obtained, and a crystal controlled transmitter was decided upon. Improvements in the receiving equipment were also planned.

The present W9CJC consists of a four-tube 1929-type receiver with plug-in coils and condensers to cover the 3500-kc., the 7000-kc., and the 14,000-kc. amateur bands. A crystal control transmitter operating on the same frequency bands, a shielded monitor with plug-in coils and finally, one of the new type General Radio Com-

The clear bell-like note obtainable with a crystal-controlled transmitter using these low-power tubes makes a combination that is difficult to beat. The oscillator, with a 3520-kc. quartz crystal in its grid circuit uses a UX-210 tube with 350 volts applied to its plate. The next tube, also a 210, is used in a frequency multiplier circuit for operation in the 7000-kc. and the 14,000-kc. bands, while the final amplifier, a neutralized device, also uses a UX-210 tube operating on the same frequency as the intermediate amplifier.

The transmitter is a double deck affair using two 7" x 18" formica panels. The deck sub-panels are also of formica. Contrary to popular amateur belief, this sub-panel arrangement works very satisfactorily, and while this type of construction requires more time to complete than the familiar "bread-board" type of construction, a very neat job results. All experimental work is done with bread-board construction, after which the final model, using sub-panel construction, is completed. This procedure is

followed because formica panels are too expensive to use in experimental set-ups. Benjamin sub-panel brackets are used, which aid in constructional work as practically all of the wiring, done with flexible hook-up wire, is located below the sub-panel.

The transmitter construction may be seen clearly in a photo. The wiring diagram of the transmitter at W9CJC is given in Fig. 1. All of the coils are of the plug-in variety, and are provided with General Radio Company plugs, the corresponding jacks for these being mounted on the formica sub-panels. The coils for the tank circuit of the oscillator and the first amplifier are wound with No. 12 enameled wire on bakelite tubing which keeps the coils mechanically strong and rigid. The coil L_1 consists of 9 turns, while L_2 consists of 5 turns of wire on bakelite tubing 3" in tubing. For 7000-ke. operation, the tank inductance of the final amplifier, L_3 , consists of 12 turns of 3/16" copper tubing wound on a 2 1/2" pipe. The antenna coupling coil L_4 consists of 6 turns of copper tubing similar to L_3 . Because of the higher resistance of the antenna, smaller tubing or wire could have been used in the antenna circuit, but the 3/16" tubing provides the requisite rigidity and was available so it was employed. Fixed, though loose, coupling is employed between the antenna coupling coil and the tank coil of the final amplifier. All tuning condensers have capacitances of 500 μ fd.

The radio-frequency choke coils are of various types and makes. Two General Radio Company chokes are used in the grid circuit of the oscillator and first amplifier. Two home-constructed chokes are used in the plate circuits of the series fed oscillator and first amplifier, while Aero transmitting choke coils are used in the output amplifier. The critical choke coil is that of the grid circuit of the oscillator tube. If the choke is so constructed that its natural frequency is near the operating frequency, the circuit will still oscillate at the frequency of the crystal when the crystal is used. If the crystal is removed from the circuit, oscillations will still persist at a frequency which is determined by the LC constant of the plate circuit of the oscillator, the oscillator in this case becoming a tuned-grid tuned-plate affair. Normally, the choke used at W9CJC in the grid circuit of the oscillator is so constructed that it is not resonant with the operating frequency and the circuit is then workable only when the crystal is plugged into its mounting in the grid

circuit, but sometimes practical use is made of the fact that the circuit will oscillate with a resonant grid choke. A small coil shunted by a 23-plate Pilot midjet condenser is used to replace the radio-frequency choke coil when the crystal fails to operate or when it is desired to change the frequency of the transformer slightly. Actually, if the choke coils were made to be resonant in the 3500-ke. band the circuit would oscillate over a considerable portion of the amateur band without any grid tuning condenser. Thus, it is possible to determine the frequency solely by

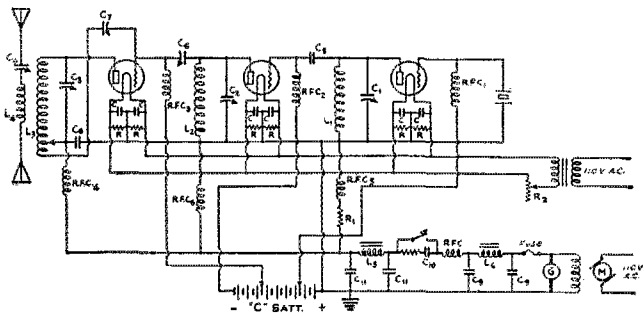

FIG. 1. — DIAGRAM OF THE TRANSMITTER AND POWER SUPPLY AT W9CJC

- L_1 — 9 turns of No. 12 enameled wire on 3" bakelite tube.
- L_2 — 5 turns of No. 12 enameled wire on 3" bakelite tube.
- L_3 — 12 turns on 2 1/2" copper tubing wound on 2 1/2" pipe.
- L_4 — 6 turns of 3/16" copper tubing wound on 2 1/2" pipe.
- L_5 — 3-henry filter choke.
- L_6 — 16-henry filter choke.
- C_1 — Filament by-pass condensers.
- C_2, C_3, C_4, C_5, C_6 — 500- μ fd condensers.
- C_7 — 250- μ fd. Sangamo condenser.
- C_8 — 23-plate Pilot midjet condenser.
- C_9 — 2,000- μ fd. by-pass condensers.
- C_{10} — 2- μ fd. filter condensers.
- C_{11} — Key thump filter condensers.
- R — Filament center-tap resistors.
- R_1 — 500-ohm resistor to reduce oscillator plate voltage to 350 volts.

the LC constants of the plate circuit of the oscillator, and a beautiful single control oscillator is the result. Tuning the grid coil will increase the power output slightly, however. With a high- C tank circuit the emitted frequency is constant and the transmitter delivers a clear, constant clean-cut signal. The tuned-grid tuned-plate version of the crystal controlled transmitter is of value if the crystal should become lost, strayed or stolen, and will serve as a very good type of transmitter for the amateur of limited means who cannot afford a crystal at the outset.

A general view of the front of the transmitter shows, from left to right, on the lower panel, the oscillator tank condenser, oscillator plate milliammeter, first amplifier tank tuning condenser, plate current meter and the variable grid excitation condenser feeding the final amplifier. The upper panel contains the antenna tuning condenser, the filament volt meter, antenna current meter and the power amplifier tuning condenser.

OPERATION OF THE TRANSMITTER

When operation is intended in the 3500-ke. band the frequency doubler tube is removed from its socket, the grid excitation clip of the doubler is removed from the first amplifier, and the grid excitation clip from C_2 of the final power amplifier on the top "deck" is attached to L_1 . About 10 turns are used in the amplifier tank circuit and two turns are required for the neutralizing circuit. The filament of the oscillator and amplifier are lighted and plate voltage applied to the plate of the oscillator tube, no

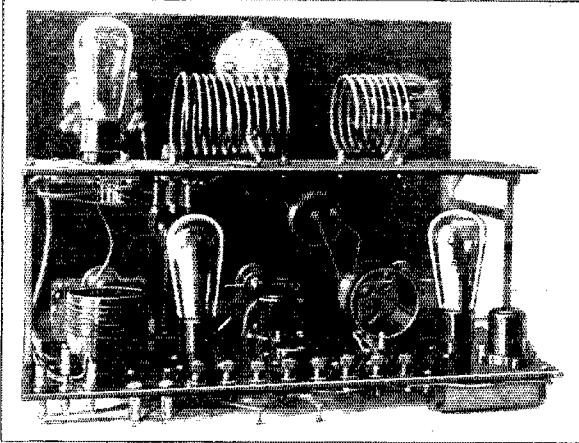

BACK VIEW OF THE TRANSMITTER

*The oscillator and first amplifier are on the lower deck.
The upper deck carries the final amplifier and antenna tuning coil and condenser.*

plate voltage being as yet applied to the plate of the amplifier tube. A flash-light bulb connected to a turn or two of rather heavy wire (to give rigidity) is coupled to the tank circuit of the amplifier, and this tank circuit is tuned to resonance with the oscillator tank circuit. The bulb will light, indicating the circuit is not neutralized and that a portion of the power delivered to the amplifier is feeding directly to the antenna. The neutralizing condenser should then be adjusted until the light goes out, and if slight readjustment of the tank tuning condenser does not light the lamp again, the amplifier is neutralized. The plate voltage is then applied to the amplifier, and with looser coupling between the tank circuit and the pick-up coil and lamp, the tank circuit and antenna circuit are tuned to resonance with the oscillator. The tank and antenna circuits will have to be adjusted together as the coupling between the two circuits does not permit independent adjustment. The frequency doubler is not used at all in this operation. For operation in the 7000-ke. band (the band in which most communication is carried

out) the frequency doubler is used, the clip from the condenser C_2 being attached to the coil L_1 . It might be well to mention here that the less grid excitation on the frequency doubler (within limits) the more stable the transmitter will be. A UX-210 tube will supply the grid losses of a 50-watt tube, so that ample excitation is available for the UX-210 frequency doublers. Consequently, the grid excitation clip from the condenser C_2 may be clipped on to the coil L_1 fairly close to the filament end of the coil. In actual practice only three turns are used to supply the grid excitation to the first amplifier. When the

circuit is keyed the oscillator milliammeter should not drop more than 5 milliamperes. The practice of supplying as little grid excitation as is sufficient with proper operation can make each circuit more independent of the rest. The lamp is now coupled to the oscillator tank circuit, and C_1 varied to obtain maximum brilliancy of the flash lamp. Neutralization is not required in the frequency doubler, and the next operation is to obtain maximum brilliancy in the lamp circuit when this is coupled to L_2 . Neutralization is carried out in exactly the same manner as already described, except that a coil suitable for 7-mc. operation is used for L_3 . Grid excitation to the final amplifier is varied by the condenser C_3 , which is more convenient than shifting the clip along the inductance. In many cases, it will be possible to obtain another resonant point with the tuning condenser, C_4 , adjusted to the position of nearly minimum capacitance. The tank circuit

will then be found to be tuned to the 14,000-ke. band, as a test with the frequency meter will prove.

For 14,000-ke. operation, the tank circuit L_3-C_3 is tuned to this lesser peak and the antenna is tuned to give maximum current either on the fundamental or a harmonic of the antenna system. The power amplifier is now operated as a frequency doubler, and it is advisable to increase the grid bias to obtain greater power output. The grid bias is fairly critical and greatly effects the power output. Grid bias is supplied by batteries, as this has been found superior to obtaining bias through the IR drop in a resistor. If sufficiently large, the plate supply unit will be capable of supplying the grid bias voltage. A grid bias of 45 volts is used on the crystal oscillator, 135 volts is used on the first amplifier, and 90 volts on the final amplifier for 7000-ke. operation. The high bias on the frequency doubler tends to make the harmonic more pronounced than low bias.

PLATE SUPPLY

Power to the plate of the tube is furnished by a 500-volt direct current Westinghouse motor-generator. This unit is mounted on a partially inflated inner tube to reduce noise and vibration. A fuse is inserted in the high voltage line to protect the tube and generator if an unusually large current is drawn from the generator. A filter consisting of a 15-henry choke coil and a 2- μ fd. condenser 'fore and aft' of the choke is used. Even without any filter, "pure d.c." reports are received, due to the fact that the crystal oscillator irons out such small modulating ripples. The amplifier tube obtains its plate voltage directly from the generator; the oscillator plate supply is obtained from the generator through a 5000-ohm resistor, which reduces the oscillator plate voltage to 350.

Keying is accomplished by inserting the key directly in the high voltage side of the plate supply lead. The key opens the plate supply of the frequency doubler and power amplifier, but permits the oscillator to operate. A key thump filter is used which keeps the neighbors happy.

THE RECEIVER

The receiver used at W9CJC is a four-tube affair using a screen-grid radio frequency coupling tube, an oscillating detector circuit, a peaked audio amplifier using a screen-grid tube with a Ford secondary coil, and a second audio amplifier. Both screen-grid tubes, as well as the Ford type of audio transformer, are shielded in Carter screen-grid shields. The receiver is a copy of the four-tube receiver described in the November, 1928 issue of *QST*, except that a National Company type B dial is used in place of the drum type of dial to give more room in back of the panel. As is done in the transmitter, the sub-panel idea is made use of. Benjamin sub-panel sockets are used which permit direct wiring with flexible cable to be accomplished easily. Three plug-in coils, covering the three most popular amateur bands, are available. The battery cable, of the plug-in variety, is used, all battery connections are broken when the plug is removed so that the midget tuning condenser may be changed without the danger of shock from the "B" batteries. And this is a necessity.

Fig. 2 shows a schematic wiring diagram.

Further details concerning this receiver are not given, as this subject has already been thoroughly covered in the past issues of the *QST*.

THE ANTENNA

The antenna used is a bent Hertz and has a fundamental of 5455 kc. The antenna and counterpoise are each 38 feet long. For operation in the 3500-kc. band, a loading coil is used, whereas for 7000-kc. operation, the loading coil is cut out and a series condenser cut into the antenna circuit. For 14,000-kc. operation a separate bent Hertz antenna is used. The antenna and counterpoise of the smaller antenna are each 16 feet long. This small antenna operates better than the

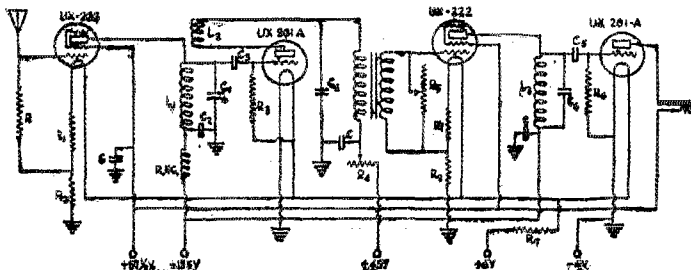

FIG. 2.—THE CIRCUIT OF THE RECEIVER USED

- C — 1- μ fd. by-pass condensers.
- C₁ — Plug-in midget tuning condensers.
- C₂ — 400- μ fd fixed condenser.
- C₃ — 100- μ fd. grid condenser.
- C₄ — 2000- μ fd. by-pass condenser.
- C₅ — 6000- μ fd. audio grid condenser.
- C₆ — 0.01 audio tuning condenser.
- CR — 10,000-ohm resistor, grid leak type.
- R₁ — 10-ohm filament and grid bias resistor.
- R₂ — 5-ohm filament resistor.
- R₃ — 6-megohm gridleak.
- R₄ — 50,000-ohm variable resistor.
- R₅ — 200,000-ohm variable resistor for volume control.
- R₆ — 5-megohm grid leak.
- R₇ — Filament ballast resistor for 0.75 ampere.
- L₁, L₂ — Tuning inductance and tickler wound on plug-in form.
- L₃ — Ford secondary coil.
- R.P.C. — Receiver type radio frequency choke coil.

larger antenna, although the larger antenna may be loaded to 4686 kc. and operated on the third harmonic for 14,068-kc. transmissions.

W9CJC is more or less of an experimental station. Any changes made in the station, such as the erection of a new antenna, or a new oscillator arrangement are carefully noted as to date, time, dial settings, antenna current, and circuit constants. Only one change is made at a time, and a record of all changes is kept over a considerable period of time, so that comparisons may be made with results obtained from previous operations. W9CJC believes that if you put up a new antenna and don't work everybody you call, that that isn't sufficient justification for trying a new antenna system immediately. Everything is given a fair trial over a sufficient long span of

(Continued on page 32)

Utilizing the Standard Frequency Transmissions

By Killian V. R. Lansing*

IT really ought not to be necessary for an article like this to be written. Every amateur "on the air" should long hence have a well-constructed, accurately calibrated frequency meter (yes, Horace, that's high-brow for wave-meter). This all too prevalent practice of adjusting the transmitter frequency by seeing as nearly as possible "where the receiver picks it up," and then seeing whether or not it is "too far" from the others will surely result in further slicing of our bands if continued, for much "slopping over" into the frequencies reserved for other services is bound to result. More than one foreign government has assigned its amateurs curtailed bands (such as 7050 to 7250 kc. instead of 7000 to 7300 kc.) so that its amateurs will actually stay within the limits set by the 1927 conference. If the present situation, particularly at the high-frequency end of the 7000-kc. band, does not improve, our government may be forced to take the same steps.

There seems to be some amateur feeling that we received a "raw deal" at the conference, but the conference, good, bad, or indifferent, is in the past and its results are the law of the land. We should even this early be looking forward to the next one and considering what privileges we are liable to obtain there if we abuse our present privileges in such a manner that other radio services will not only be jealous of the frequencies we retain, but even of having our frequencies anywhere near theirs on account of the interference caused by us. Granted that it is only a small minority that causes interference, nevertheless we all get the resulting black eye. This off-frequency operation becomes not the private business of the offender, but the business of all of us.

The remedy is the frequency meter. To my mind the possession of a moderately good and well-calibrated meter should be made a prerequisite to the issuance of a station license and to renewals thereof. Such a meter in its simplest form consists merely of a coil, a condenser, and usually some sort of indicating device. It's probably the simplest and cheapest instrument in an amateur station, yet approximately 25 per cent of the Los Angeles stations which the writer has visited in recent months have had no frequency

meter of any kind. Perhaps, though I doubt it, Los Angeles is unusually bad in this respect, but it's pretty safe to say that from 15 to 25 per cent of the amateurs of this country have no meters. It's also pretty safe to wager that if our bands are ever curtailed still further, these fellows will be the first to kick.

Why do so many lack meters? It can't be the cost. Good meters are advertised in *QST* and elsewhere at reasonable prices, and one can be made at home for next to nothing. It can't be the difficulty of construction, for such a meter is far simpler than the simplest "ham" receiver or transmitter ever constructed. It is not my purpose to describe such meters here; *QST* has described dozens in the past few years; others will be found in the *Radio Amateur's Handbook* by Handy and Hull. See particularly *The Frequency Measurement Problem*, page 9, October, 1928, *QST*.

There seems then, only two possible reasons why stations without meters exist: (1) General laziness and cussedness, and (2) difficulty of calibration. For the first, the A.R.R.L. can do nothing. For the second, the League with the coöperation of the Standard Frequency Stations has done and is doing a real service.

Various methods have been described in *QST* for calibrating a meter by the use of the signals of fixed-frequency stations such as WIZ, WIK, and the better broadcasting stations, using the harmonics of an auxiliary oscillator or receiver tuned to the frequency of the incoming signal. Such methods are far less complicated than they appear in print. An excellent recent article is *Calibrating the Heterodyne Frequency Meter or Monitor*, by George Grammer, W3AIIH, which appeared in April, 1929, *QST*. This method can very easily be extended to calibrate an ordinary frequency meter, although I agree with Mr. Grammer that the oscillating type frequency meter is by far the more satisfactory for traffic stations and for quick frequency checks, either on your own transmitter or on a distant one.

The Standard Frequency Transmissions remove the last possible objection to constructing and calibrating a frequency meter by *handing you exactly the frequencies you want*. Do you want to know where 7300 kc. is on your meter? All right; the Standard Frequency Station will send you a signal exactly on 7300 kc., and there is no necessity of auxiliary oscillators, checking harmonics,

* W6QX, care Multi-Radio Co., Engineers, Box 666, Hollywood, Calif. Member Official Frequency Station Committee; in charge of Standard Frequency Stations.

or much else. All you need is the meter and a receiver to hear the signal.

These schedules cover a number of points in each of the prominent amateur bands, are made up long in advance, and published in *QST*. They are arranged by the Official Frequency Station Committee of the League's Experimenters' Section, and are transmitted through the courtesy and hard work of the staffs of W9XL and W1XV. W9XL is the Gold Medal Station, R. F. D. No. 3, Anoka, Minnesota and H. S. McCartney is in charge, assisted by Lyall K. Smith, Ivan H. Anderson, and George Collier. W1XV is the Communications Experiment Station of the Massachusetts Institute of Technology located at Round Hill, South Dartmouth, Mass., with H. A. Chinn in charge. Both stations have efficient, steady transmitters with good notes and considerable power.

There is no reason why a standard frequency signal should not be identified if heard at all no matter how bad the interference; during the eight minutes' transmission period of each standard frequency, the station frequently signs its call letters for identification; furthermore, instead of using the letters "t-e-s-t" or the signal . . . for a test signal, each station uses a special test or

"characteristic letter" to assist in identification. "D" is the characteristic letter of W9XL, while W1XV uses "G." Each schedule starts at the (low-frequency high wave) end of the band being covered. Even on a brand-new receiver the approximate tuning position of this point can be determined in a few minutes by listening to the amateurs on that band, and thus the standard frequency signal should be found without undue difficulty. From there, points are given in regular order and at approximately equal intervals up (in frequency) the band and should be followed without much trouble. Evening schedules are now being sent in the 3500- and 7000-ke. bands and afternoon schedules in the 14,000- and 28,000-ke. bands.

Once the standard frequency signal is being received the sole remaining operation is to "transfer" it to the meter. If the meter is of the ordinary type, this can be done by the resonance click method which has been described so many times in these pages. Simply bring the meter near the coil of the receiver, and slowly vary the setting of the condenser until a click is heard in the phones as the resonance point is passed. This particular setting of the condenser may then be marked as

(Continued on page 76)

Finding the Expeditions

Expedition Station	Frequency (kc.)	Call Signal	Remarks
Yacht <i>Carnegie</i> , Dept. of Research in Terrestrial Magnetism, Carnegie Institute of Washington.	9045	WSBS	In second year of three-year world cruise. Arrived San Francisco on schedule July 29, sailing for Honolulu, Apia, Lyttelton, So. Georgia, St. Helena, Cape Town, etc., Aug. 23. Operator, Stuart L. Seaton of W3BWL.
Schooner <i>Bowdoin</i> , MacMillan Expedition to Northern Labrador	12970 8650 4320	WDDE	Look for WDDE on 23.18 meters. Nightly operation starts at 6:30 p.m., E.S.T. The schedules and general work are indicated in our full report received via W1AFB from a position near the Labrador coast. Operator, R. E. Brooks, of W9AFA.
Base Station, All-American Lyric Malaysian Expedition, Poeroek, Tjahoe, Borneo	7330	PMZ	Several months will be spent in the jungle conducting radio and other research work. Traffic should be filed with W1MK or W6AKW to be sent to PMZ direct or via KIAF or K1CY. Operator, Harry W. Wells, ex3ZD.
Yacht <i>Rippee</i>	8290 5525	KFLF	Sailed from Baltimore for New York City about August 1. Keeps daily schedules with W8GZ who routes Los Angeles traffic via W6CJ. Operator, J. R. Foran. QSL to Box 188, Bradenton, Fla.
Yacht <i>Nauad</i>	8370 468 500	WHDC	On world cruise. San Francisco QRD the South Seas. Operator, Stephens Miranda.
Yacht <i>Tempress</i>	8350	WIDJ	On Tahiti cruise. Operator, exW6CZX.
Base, Byrd Antarctic Expedition, Lat. 78 34 S, Long. 163 30 W.	8810 6580 13,180	WFA	WFA calls CQ after regular schedules, also at 0400, 0700, and 1000 GCT daily, choice of frequency depending on season and conditions. Operators, Berkner, Hanson (MP), Peterson (PETE) and Mason (MN).
S.S. <i>Eleanor</i> , Boling of Byrd Expedition	8830 7310	WFAT	Worked W9CSB with traffic using 7310 kc. from port at Dunedin, N. Z.
S.S. <i>Lake Ormoc</i> , Ford Motor Company	8650	KVUA	Bases at rubber plantation at Santa Ream, Brazil.

The A.R.R.L. Official Frequency System

THE Official Frequency Station Committee, a part of the Experimenters' Section of the A.R.R.L., has arranged the services described below for the benefit of the members of the League and others who may wish to use them.

1. Standard Frequency Transmissions are sent by the Standard Frequency Stations (known as O.F.S.-S.F.) on definite schedules with a high degree of accuracy. All the principal amateur bands are covered, several points being given in each so that frequency meters may be accurately calibrated. These transmissions are based on piezo-electric frequency standards that are regularly checked by one or more of the leading scientific laboratories of the country.

2. Official Frequency Transmissions are sent by Official Frequency Stations (known as O.F.S.) at a somewhat lesser degree of accuracy. These stations do not transmit on regular schedules but announce their frequency at the end of at least every other transmission during their regular amateur operation. Such stations will measure the frequency of your transmission upon request.

Practical suggestions are always welcome and should be sent to the proper member of the Committee which is composed of the following: Don C. Wallace, W6AM, Chairman in charge of O.F.S., Room 410, 209 Pine Ave., Long Beach, Calif.; Prof. C. M. Jansky, Jr., care of University of Minnesota, Minneapolis, Minn.; and Killian V. R. Lansingh, W6QX, in charge of O.F.S.-S.F., Box 666, Hollywood, Calif.

STANDARD FREQUENCY SCHEDULES

Time (p.m.)	Friday Evening Frequency, kc.			Time (p.m.)	Friday and Sunday Afternoons Frequency, kc.		
	A	B	AB		BB	C	CD
8:00	3500	6900	7000	4:00	6900	13,900	28,000
8:12	3550	7000	7100	4:12	7000	14,000	29,000
8:24	3600	7100	7200	4:24	7100	14,100	30,000
8:36	3700	7200	7300	4:36	7200	14,200	14,000
8:48	3800	7300	3500	8:48	7300	14,300	14,200
9:00	3900	7400	3650	5:00	7400	14,400	14,400
9:12	4000	3850				
9:24	4000				

The time is the local standard time at the transmitting station. 8:00 P.M. at W1XV-W1AXV is 0100 G.C.T. and 8:00 P.M. at W9XL-W9WI is 0200 G.C.T. Similarly, 4:00 P.M. at W1XV-W1AXV is 2100 G.C.T. and 4:00 P.M. at W9XL-W9WI is 2200 G.C.T. Due to the new regulations of the Federal Radio Commission concerning experimental licensed stations, the Standard Frequency Stations will in all probability use the amateur calls W1AXV and W9WI for these schedules.

DATES OF TRANSMISSION

Date	Schedule	Station
Sept. 1, Sunday	CD	W9XL-W9WI
" 6, Friday	A	W1XV-W1AXV
" 13, "	BB	W1XV-W1AXV
" 13, "	AB	W9XL-W9WI
" 20, "	B	W1XV-W1AXV
" 22, Sunday	C	W1XV-W1AXV
" 27, Friday	AB	W9XL-W9WI
Oct. 4, "	A	W1XV-W1AXV
" 6, Sunday	CD	W9XL-W9WI
" 11, Friday	BB	W1XV-W1AXV
" 11, "	AB	W9XL-W9WI
" 18, "	B	W1XV-W1AXV
" 25, "	AB	W9XL-W9WI
" 27, Sunday	C	W1XV-W1AXV

Schedule "BB" sent at 2100 G.C.T. on one Friday of each month is transmitted at that hour for the particular benefit of European stations. If sufficient reports on its reception are not received, it will be discontinued. Since the 5700-kc. frequency is no longer available for use by Canadian amateurs, transmission of a standard frequency on that channel has been discontinued.

THE STATIONS

W1XV-W1AXV: Massachusetts Institute of Technology, Communications Department Experiment Station, Round Hill, Dartmouth, Mass., H. A. Chinn in charge. Uses Eastern Standard Time and characteristic letter "G."

W9XL-W9WI: Gold Medal Station, R. F. D. No. 3, Anoka, Minn., H. S. McCartney in charge, assisted by Lyall K. Smith, Ivan H. Anderson and George Collier. Uses Central Standard Time and characteristic letter "D."

DIVISION OF TIME

A total of 12 minutes is allotted to each transmission divided as follows:

- 4 minutes — QST QST QST de (call letters).
- 3 minutes — Characteristic letter ("G" or "D") sent very slowly and broken by call letters each half minute.
- 1 minute — Statement of frequency in kilocycles to nearest integral figure.
- 4 minutes — Time allowed to change to next frequency.

ACCURACY

The transmissions of both stations will be within 1/10 of 1% of the frequencies herein announced, which is considerably better than the accuracy to which the average good amateur frequency meter can be calibrated and maintained constant. During each transmission by W1XV-W1AXV the integral frequency nearest its exact frequency within 1/100 of 1% will be

(Continued on page 50)

Experimenters' Section

THE "DOUBLET" FOR RECEIVING

THE idea of applying the "doublet" type of antenna system for reception must have occurred to many and has probably been tried before this as theory of it is so simple. Fig. 1 shows the arrangement consisting of two wires of a total length such that the natural frequency is near the middle of the band on which reception is desired. (This total length may readily be determined by taking the natural wavelength and multiplying it by 1.56, the answer being in feet. For the 7000-kc. band, this length should be around 64.5 feet.

"The idea was suggested by Fred Roebuck one day when he and Ralph Heintz were at W6HM. A visit was immediately made to the village where the lamp-cord was secured and the doublet was made up. It peaks at a point slightly below the middle of the 7000-kc. band, the two sections of the antenna being each 32 feet, 8 inches long and the lamp-cord feeder 45 feet in length. For a trial, it was hooked up to a little t.g.t.p. receiver which uses a pair of Canadian peanut tubes and which had always been used capacitively coupled to a vertical wire 100 feet long. A little antenna coil

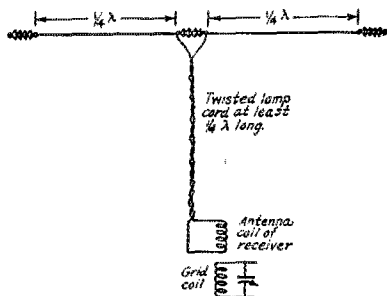

FIG. 1

was rigged up on a piece of dry shingle screwed to the window-sill just back of the receiver and the ends of the feeder were clipped to the coil. With the screw not all the way down and coupling pretty close to the grid coil, the resonant spot was just a little below the middle of the band. At this point the receiver stopped oscillating. Setting the screw down tighter raised the thin end of the shingle and loosened the coupling until the receiver started oscillating again—and there it was left. Signals come in a great deal louder than with the 'untuned' antenna and there is no increase in background noise. In fact, the detector goes into oscillation so quietly that it is difficult to determine just where it starts. The antenna works just as well on the 14,000-kc. band, and even 'way off the center of the 7000-kc. band sigs are better than with the untuned antenna used here.

"W6AM thinks that the Zepp transmitting antenna would work just as well for reception and Fred Roebuck suggests that the feeder might be better if the wires were spaced about every three feet as the resistance and distributed capacity would be considerably reduced, 'cancelling' taking place just the same.

"W7MO was given the dope and reports that the signals are about twice as strong as with his other receiving antenna, while there is no increase

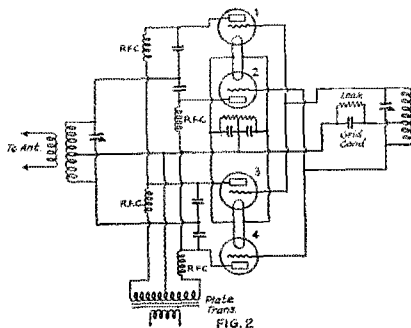

FIG. 2

in background noise level. Other experimenters may also find the system advantageous, particularly in locations where the noise level is high."

—Clair Foster, W6HM.

PUSH-PULL SELF-RECTIFIED T.G.T.P. CIRCUIT

W. H. Martin of 2270 Ocean View Blvd., San Diego, Calif., suggests the push-pull self-rectified, tuned-grid tuned-plate transmitting circuit shown in Fig. 2. While the arrangement may appear complex, it is necessary if the transmitter is to operate in true push-pull fashion at radio frequency while self-rectifying at plate supply frequency.

A study of the circuit reveals that the plates of alternate tubes are in parallel with respect to the a.c. plate supply and in push-pull with respect to oscillation frequency. Each of the pairs, 1-3 and 2-4, alternate in oscillating push-pull with alternations in the plate supply voltage.

Considerable difficulty might be experienced in getting the circuit properly balanced to realize identical frequency of oscillation from each pair of tubes on their respective alternations, but care in circuit design and the use of well matched tubes should eliminate this difficulty, particularly if each tube should be provided with individually adjustable grid leak and grid condenser. The thing looks intriguing and should provide an interesting bit of experimental work.

GRID BIAS FOR THE SCREEN-GRID TUBE

"A very good grid bias arrangement for the

screen-grid tube used in a radio frequency amplifier can be made from an ordinary 20-ohm filament rheostat as shown in Fig. 3. The link connecting the rotating arm to one end of the resistance unit is removed and a flexible lead is soldered to the rotating arm, which is then replaced. The resistance element is connected in the negative filament lead at the socket terminal. The flexible lead is connected to the grid return, the grid bias being adjusted by rotating the contact on the resistance element.

"This makes a more satisfactory and, if an old rheostat is available, a cheaper arrangement than



FIG. 3

the tapped fixed resistor. It may be mounted on the receiver panel or sub-panel and once properly adjusted it may be left set."

— W. T. Clayton, Jr., Magnolia, Miss.

MOUNTING CONTACTS ON SCREWS AND RODS

"Have you ever built a relay or made anything that required a contact on the end of a screw or rod? Have you cursed and cursed because the drill followed every direction but that parallel to the axis of the screw or rod? Well, whether you have or not, just put the following down in your note-book and profit by my experience.

"The suggestion which is contained in this article has been thoroughly tested and tried out on some several hundred contacts and screws, and the results were so pleasing that it has been decided to hand it over to QST. The idea has never before been seen in any technical pages and it is believed that it may attract the attention of many experimenters because of its usefulness.

"Fig. 4 illustrates the temper-saving device. First, select a piece of iron, preferably cold-rolled, or if you want to work harder, tool steel is the thing. It should be from 1/2" to 1" thick according to the purpose for which you are going to use it; the thicker the stock, the longer the life of the tool.

"If you are mounting contacts, determine the size of the shank of the contact, or if it's a rod, determine the diameter of the rod and then secure a drill this exact diameter or .001" smaller. Drill a hole from the face of the tool, completely through it. Next, determine the thread to be used and get the corresponding tap-drill and drill half-way or less through the tool, starting on the same side as you did before and in the same hole. Your drill will act then as a reamer rather than as a drill. Now tap the hole to the size of the thread of the screw upon the contact which is to be mounted.

"Work the screw into the threaded hole,

screwing it in far enough to have it catch where the hole is reduced to the size of the original hole. This is half-way through the tool. Turn the tool over and drill into the screw shank with the drill that is the size of the contact shank. Of course, you have to judge the depth of the contact shank.

"This done, you are ready to remove the screw, insert the contact and hammer gently. You will find, if ordinary care has been used in constructing the tool, that you can drill the screw from end to end and not break out the side.

"A few of the ordinary sizes of threads and tapdrills are included in the following list:

Thread	Drill
6-32	36
6-40	33
8-32	29
8-40	28

— R. E. Kepler, WSOT, 3981 W. 233 St., Fairview Village, Cleveland, Ohio.

CHOOSING THE PROPER MODULATOR TUBE

W2JS supplies the following table which indicates the relative desirability of tubes of the two general classes most used by amateurs as modulators in the Heising system. The modulator plate input is assumed to be normal for the tube specified and the plate input for the oscillator or amplifier (Class C) is at the same plate voltage as that of the modulator tube. If the modulating system is such that the modulator plate voltage is higher than that of the Class C oscillator or amplifier tube being modulated, as in the 100 per cent Heising system described in this and the April issue of QST, the input of the r.f. tube may be considerably increased. The table below,

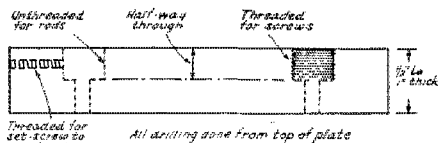

FIG. 4

however, is for equal plate voltages on the modulator and r.f. tubes, the peak percentage of modulation being assumed as 60 (modulation factor 0.6).

Tube Used as Class A Modulator	Plate Input to Class C Oscillator or Amplifier
UX-210	4 watts
UX-842	8 "
UX-250	12 "
UX-203-A	17.5 "
UV-211	45 "
UV-845	120 "

From the above table it is clearly evident that the most effective modulator for a UX-210 used as a Class C oscillator or amplifier at normal plate voltage is the UX-250. The UX-842 is second choice while the UX-210 as a modulator is obviously quite unsuited. Similarly, for a 50-watt

Class C oscillator or r.f. amplifier, the UV-845 is the most effective with even the UV-211 a poor second choice.

Definitions of the various amplifier classifications, "A," "B" and "C," will be found in the article, "Vacuum Tube Amplifier Definitions," appearing in this issue. The system of modulation considered is, of course, the Heising.

LOOP TRANSMISSION AND RECEPTION

With the problem of interference between stations becoming increasingly more acute and the desirability of greater selectivity growing in proportion, it is highly probable that application of the loop antenna for both transmission and reception on amateur frequencies may prove worthwhile. In addition, directional transmission has been shown to be extremely effective on the 28,000-ke. band and may prove to be the solution for successful communication on the 56,000-ke. band. The physical size of antenna systems for these two bands is comparatively small, and loop systems suitable for both transmission and reception on these frequencies are within the space limits possible to most amateurs.

It may therefore be considered appropriate to suggest that experimental work involving the use of loop antenna systems for both transmission and reception on all our bands be given consideration by those experimenters in a position to do some good work on the problem. Something new and valuable can, without doubt, be worked out. It always is when an earnest group of amateurs tackle a thing.

A bibliography of references on loop antennas for transmission and reception follows. New applications and modifications of the material contained in these references will do the trick.

BIBLIOGRAPHY ON LOOP TRANSMISSION AND RECEPTION

QST References:

- Loop Transmission, by Bishop, pp. 7, Jan., 1923.
- Loops for Sending, pp. 38, May, 1923.
- Loop Receiver Picks Up U. S. Hams, by Z3AA, p. 53, Dec., 1923.
- Low Power Loop Transmission, by O. Wright, pp. 39, Jan., 1924.
- Low Loss Loops? by Harper, pp. 21, Dec., 1924.
- CW on a Loop, pp. 38, Feb., 1925.
- Top Loading Antennas and Loops, by Murphy, pp. 49, May, 1925.
- Low-Power Report (Includes Loop Transmitter), by L. W. Hatry, pp. 44, June, 1925.
- Loops and Ford, by O. Wright, pp. 33, July, 1925.
- A Neat Loop, pp. 38, July, 1925.
- Locating "Power Leaks," by Radio, pp. 13, Sept., 1925.
- Amateur Wave Changers (Contains Loop Data), by Clapp, pp. 35, April, 1926.

The Flying Loop, by Wright, pp. 53, Dec., 1926.

A Short-Wave Loop Receiver, by Preece, pp. 43, May, 1927.

Proceedings I. R. E.:

Antennae, by Pickard, pp. 6, May, 1909.

Antennae Discussion on Pickard Paper, pp. 16, June, 1909.

The Possibilities of Concealed Receiving Systems, by A. H. Taylor, pp. 261, June, 1919.

Radio Direction Changes and Variations in Audibility, by Kinsley, pp. 324, Aug., 1920.

Quantitative Experiments with Coil Antennas in Radio Telegraphy, by Austin, pp. 416, Oct., 1920.

The Reduction of Atmospheric Disturbances in Radio Reception, by L. W. Austin, pp. 41, Feb., 1921.

Loop Uni-Directional Receiving Circuits for the Determination of the Direction of Atmospheric Disturbances, by L. W. Austin, pp. 395, Aug., 1923.

The Polarization of Radio Waves, by Pickard, pp. 205, April, 1926.

Portable Receiving Sets for Measuring Field Strengths at Broadcasting Frequencies, by Jensen, pp. 333, June, 1926.

Discussion of Pickard's Polarization Paper, by Alexanderson, pp. 391, June, 1926.

Reduction of Interference in Broadcast Reception, by Goldsmith, pp. 575, Oct., 1926.

Directional Radiation with Horizontal Antennae, by Meissner, pp. 928, Nov., 1927.

Abbreviated Method for Calculating the Inductance of Irregular Plane Polygons of Round Wire, by Bashenoff, pp. 1013, Dec., 1927.

The Chireix-Mesny Directive Antennas for Short Waves, a review by Ballantine, pp. 1261, Sept., 1928.

The Receiving System for Long-Wave Transatlantic Radio Telephony, by Bailey, Dean, and Wintringham, pp. 1645, Dec., 1928.

Radio Broadcast:

Construction and Operation of a Loop Radiophone Transmitter, pp. 51, 1922.

Text-Books:

Robinson's Manual of Radio Telegraphy and Telephony (U. S. N. I.).

Principles of Radio Communication, by J. H. Morecroft (Wiley).

Radio Engineering Principles, by Lauer and Brown (McGraw-Hill).

ADDITIONAL PORTABLE SET REFERENCE

To the bibliography on portable sets (Problem T-28) which appeared on page 46 of July QST, there should be added a very pertinent reference on the subject. This is: "Following the Sun with a Radio Flivver," by Elser, QST, Sept., 1927, page 9. This reference was inadvertently omitted from the bibliography.

The Communications Department

F. E. Handy, Communications Manager
 E. L. Battey, Asst. to Coms. Mgr.
 1711 Park St., Hartford, Conn.

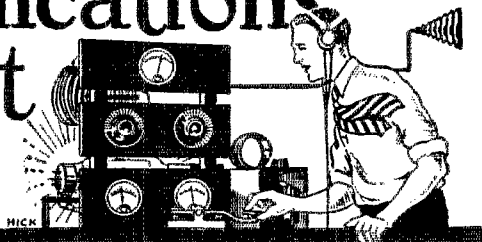

Propagation of Signals

THE following table will show one the probable best time or times at which he can work several of the countries and continents in which there happen to be active amateurs. It should be noted that this schedule contains data on only the 14-mc. and the 7000-ke. bands. This table is something that has been needed for some time. There

We are indebted to Mr. Thomas W. Connette, W8AFM, of Lockport, N. Y., for this table, which has been compiled from observations made of the transmissions from General Electric's high frequency stations. All times specified are Eastern Standard. This table was made at 75° Lat. and 42° Long. The table follows:

Country	7000-ke. Band	14-mc. Band	Season
Germany	5 p.m.- 1 a.m.	{ 11 a.m.- 8 p.m. } { 2 a.m.- 5 a.m. } November to February
	8 p.m.-12 midnight.....	{ 3 p.m.- 9 p.m. } { 12 midnight-4 a.m. } February to May, also August to November
	8 p.m.-10 p.m.	{ 4 p.m.- 9 p.m. } { 12 midnight-2 a.m. } May to August
Argentina	7 p.m.- 3 a.m.....	{ 5 p.m.- 9 p.m. } { 4 a.m.- 6 a.m. } November to February
	7 p.m.- 4 a.m.....	{ 6 p.m.- 9 p.m. } { 4 a.m.- 6 a.m. } February to May, also August to November
	9 p.m.- 4 a.m.....	{ 5 p.m.-10 p.m. } { 3 a.m.- 6 a.m. } May to August
Australia	5 a.m.- 7 a.m.	{ 2 p.m.- 6 p.m. } { 11 p.m.- 4 a.m. } { 7 a.m.-10 a.m. } November to February
	5 p.m. and 3 a.m.-6 a.m.....	{ 12 midnight-5 a.m. } { 8 a.m.-10 a.m. } { 3 p.m.- 7 p.m. } February to May, also August to November
	6 p.m.- 7 p.m. } 2 a.m.- 4 a.m. }	{ 1 a.m.- 5 a.m. } { 8 a.m.-10 a.m. } { 4 p.m.- 7 p.m. } May to August
	New Zealand	3 a.m.- 7 a.m.....	{ 9 p.m.- 4 a.m. } { 7 a.m.- 9 a.m. } { 1 p.m.- 3 p.m. }
5 p.m.- 7 p.m. } 4 a.m.- 7 a.m. }		{ 11 p.m.- 4 a.m. } { 8 a.m.-10 a.m. } { 3 p.m.- 5 p.m. } February to May, also August to November
1 a.m.- 4 a.m.		{ 10 p.m.- 3 a.m. } { 8 a.m.-11 a.m. } { 6 p.m.- 7 p.m. } May to August
India	6:30 a.m.-7:30 a.m. } 5 p.m.- 8 p.m. }	{ 8 a.m.- 3 p.m. } { 11 p.m.- 6 a.m. } November to February
	6 p.m.- 7 p.m.....	4 p.m.-10 p.m. February to May, also August to November
	Nil	8 p.m. to 9 p.m. May to August
South Africa	5 p.m.- 9 p.m.	{ 2 p.m.- 7 p.m. } { 11 p.m.- 2 a.m. } November to February
	7 p.m.-11 p.m.....	{ 2 p.m.- 8 p.m. } { 12 midnight-2 a.m. } February to May, also August to November
	8 p.m.-11 p.m.....	{ 3 p.m.- 9 p.m. } { 12 midnight-2 a.m. } May to August

undoubtedly would be more foreign contacts if only more amateurs knew when to attempt contact with a given country.

* Abstracted from a lecture given by Mr. M. L. Prescott of Genl. Elect. Co., before the Radio Assn. of Western N. Y.

Best signal obtains with the transmitting station in a dark zone and the receiving station in daylight when the transmissions must be made over a path along which both darkness and daylight exists.

Let's Improve Our Operating Practises

By Bayard Allen*

The Communications Manager invites contributions on every phase of amateur communication activity, offering prizes for the best article selected each month from those submitted. The author whose article appears to have the greatest value each month has his choice of (1) a copy of the Radio Amateur's Handbook bound in Algerian, (2) six pads of A.R.R.L. message blanks, or (3) 500 A.R.R.L. log sheets. If a second prize article is printed, a reward similar to one of the above will be selected by Headquarters and forwarded to the winner. The right is reserved to use other articles at any time with the usual credit to the author. A wide variety of subjects on which articles would be welcomed appeared with our original announcement (March QST, page 62) and the offer stands good for all articles received in 1929 marked for attention in connection with the contest. If you could use one of our prizes, here is a way to get it free of charge by giving all amateurs the benefit of your practical experience. So far 60% of those entering our contest have received prizes. You have better than a 2:1 chance of winning out and don't need to worry about competition. Why not sit down and send us your ideas today?

The prize winning article by Mr. Allen calls attention to some of the faults most common in present-day operating practise, and suggestions for improvement based on standard procedure are made. The examples of proper and improper operating should be clear to all.

— EDITOR.

IT is said that, "Constant dripping of water will wear away the hardest stone," but by listening to any one of the five amateur bands, it would seem that the majority of our station operators, are hard babies. They seem never to have heard or seen in print the correct way to use our abbreviations and standard procedure.

At times, when the spirit moves me, I handle traffic, but due to the fact that my station is of very low power, it is necessary for me to do considerable listening in order to do effective work. By this I mean that, instead of calling "CQ West" or whatever direction I have traffic for, I listen for signals from that particular direction or state. Sometimes I can hear no CQs from a particular state and on this account, I use a plan which works splendidly with all stations that observe A.R.R.L. standards of operating.

For example: I have a msg for Pennsylvania and after listening, I can hear no CQ from that state but finally I do hear W3XXX, who by quick reference to my call book, I find is located in Eastern Pennsylvania. He is just finishing a QSO with W9XXX. I hear W3XXX give his 73 and sign SK. So, presuming that he is following A.R.R.L. practise, I call him and ask for a BK. He comes on again; but lo and behold, he is back on talking to W9BXX again. So I wait patiently and again he signs SK. I start calling him and for a second time I hear him, only to get blue in the face when I hear him going back to W9XXX. However, having a little patience left, I wait until he signs SK again. Then I call him. Pretty soon I hear him again and, stopping my call, I hear him letting out a rapid-fire CQ. Now if I had no traffic I would never wait for him to sign, but I have traffic, and so I answer him. In about 30 seconds I hear him starting to call so I stop my calling to listen. I find he is starting another five minute, or maybe longer, breath-taking CQ interposing instead of the conventional, or at least I always have thought it to be correct, Is it any wonder that we have padded calls? Now I have wasted probably 20 minutes trying to get in touch with W3XXX in order to get traffic off my hands, when I could, if he had followed the A.R.R.L. practice, had the message in his hands in five minutes.

Many fellows fail to grasp the fact that the fellow on the other end of the QSO (or prospective QSO, if you are calling him) only knows you and bases his estimation of you through listening to your fist and your operating manners. A good fist takes practise. Sensible operating, however, calls for only enough intelligence to read the "Rules and Regulations" and to follow them.

When you sign SK, mean it. Don't come back again for another 73 or to say but to listen, to cover the band, and to find any calls for your station. It is possible

to have many a QSO by following up an SK sign — provided that the signing station actually means SK. "I am thru with you and will now listen for other calls."

Some time ago, I had a message for Massachusetts, and after listening, I found I could hear no one calling CQ from that particular state, but I did hear W1--- finishing a QSO. I called him when he signed "SK" and soon he "broke me" and gave me the GA signal. Now after I had raised him, instead of calling and signing about sixteen times, I called once only, asking "QSP Springfield? K." Immediately he came back with GA MK. Naturally this particular message was in his hands and acknowledged or QSLed by "W3ATJ de W1--- 16 R QTC? K." I didn't have to wait while he called me for three minutes and signed a half a dozen times and then disgraced himself by "R R R R R OK OK OK all OK except address and text pse rpt. k." That sounds unreasonable but I have had it happen several times.

Would you prefer to try to give your traffic to such an operator or to enjoy a snappy transmission with an operator who uses standard practises and intelligent time-saving procedure? A five minute study of A.R.R.L. practise in the Radio Amateur's Handbook (or in the Rules and Regulations, a booklet sent free on request), will enable one to learn operating methods quickly and easily.

Then why, oh why, does nearly every QSO sound the same: "R GE OM UR FB DC SIGS—QNA 4 HR IN PODUNK . . . — TKS FER RPT ES 73." Sometimes it is varied with a weather report or a full QRA thrown in for good measure. It sounds like an army of mechanical robots transmitting. After such QSOs, I have received a card from the amateur station worked with the letters "RCC" on it. To such fellows, RCC must mean Radio Chats Cancelled.

Fellows, here's to better operators and more intelligent operating. Last night a friend of mine came in to see the transmitter and said "Whom are you talking to?" I said "Just W6--- in Calif." (No foolin' it was a 6.) Then he asked, "What is he saying?" and I replied, "Oh, he says my 'signs' are QNA4 (believe it or not) . . . but Joe Collich was persistent. "Doesn't he say anything else but that?" I groaned and said, "Yes, he says Good night & 73."

And so will I. 73. SK W3ATJ.

TRAFFIC BRIEFS

The Amateur Extra First Class Operator's license continues to attract considerable attention wherever examinations are being given. At the recent Ames Convention in Iowa, W9CTW passed with flying colors. Incidentally, it is interesting to know that each individual on the staff of the Communications Department is now licensed as Radio Operator, Amateur Extra First Class.

* W3ATJ, 416 Mount View Ave., Mount Holly, N. J.

Expeditions

WDDE

WDDE Nr. 108, July 24 (by radio via W1AFB) — Radio conditions along the Labrador coast are now very poor. The 20-meter band is the only one of value since reaching Nain, July 14th. We have had wonderful help from a number of amateur stations. A total of 403 messages were sent and 29 received from June 22nd to July 23rd. Special mention must be made of the following stations handling most of our traffic: W8DLL, W2AW, W9ETA, W9EF, W3ATN.

The following stations were worked during this period: W1AFB, W1BAL, W1CJE, W1CMX, W1RY, W2AER, W2AW, W3BAI, W2BJG, W2BJV, W2BPA, W2CWX, W2PP, W3AB, W3ADM, W3APN, W3UT, W8AFG, W8AXA, W8DCM, W8DLL, W8BPP, W8CCW, W8CMB, W8CUT, W8DC, W9BCN, W9CFI, W9EBB, W9EBT, W9EF, W9EJO, W9ETA, K4KD and G5BY. Seventy threes to all.

Sig. Brooks.

PMZ

Direct radio communication has been established between the United States and the main base of the All-American Lyric Malaysian Expedition, now at Peorock-Tajhoe, 250 miles up the Barito River and some forty miles south of the equator in the jungles of Dutch Borneo. The expedition has contacted with W7BB at Seattle, and with an un-named station at Phoenix, Arizona, also with W6DQC, W6CWW and W6DQV, but most of the traffic received has come through W6AKW, or through Philippine amateur stations, to this country via W6AKW at Lancaster, California. Conditions in central Borneo have been better for transmitting than for receiving, due to the electrical storms which cause almost continual QRN. Faced with the possibility of being cut off from the coast city of Bandjermasin because of the lowering of the Barito River due to drought, the expedition is preparing to depend wholly on radio amateurs as a means of contacting with civilization. The purpose of the expedition is to study tropical and equatorial radio conditions as well as to investigate the primitive tribes dwelling in the interior of the island.

Operator Wells visited Java and Japan on his way to the present location in Borneo. He reported that in spite of the monthly fee of one yen to the government, the Japanese are great followers of broadcasting, as is well demonstrated by the large numbers of bamboo poles used as antenna supports. Also there is a growing feeling against the present government prohibition against the operation of amateur radio stations. Portable equipment has been constructed which will be used by the advance or anthropological section of the expedition in keeping in touch with the base station, PMZ. PMZ now using this portable on 35-day trip.

WSBS

The June report appeared in last QST, and we are glad to be able to present the missing May report at this time, as this shows some of the difficulties of operating in the tropics: During May, conditions in general were excellent. Schedules were kept with K1AF in Manila; OM1TB in Sumay, Guam; J1CT near Yokohama, Japan, and KUP in San Francisco. The contact with OM1TB enabled the expedition to arrange for a pilot three days before arrival at that port. It was noted that on the 31st of the month, neither K1AF nor J1CT could hear WSBS, although signals had been excellent the preceding nights. This was interesting because the Manila Observatory weather reports, received through the courtesy of K1AF, indicated the presence of a typhoon in the region separating the *Carnegie* from these two stations.

One by one the three new audio-amplifying transformers received at Apia, Samoa, went bad due to the harmful action of the tropic climates. At the end of the month, "LJ" was forced to receive with no audio amplification whatever, which limited WSBS to scheduled work. Signals in general were too weak to be heard above the creaking and working

of the vessel under these conditions. The transmitting antenna also parted at about this time, making repair and replacement necessary. The expedition expresses thanks to those stations which so kindly cooperated in various ways. OM1TB handled various messages in addition to arranging for a pilot at Guam. K1AF supplied nightly weather reports. J1CT furnished exceedingly accurate and useful information. KUP and K6DTG were very faithful in keeping schedules.

Amateurs the world over will miss the pleasant contacts with Operator Lawrence A. Jones of the *Carnegie*, better known to the fraternity as "LJ." Mr. Jones has found it necessary to resign before the vessel leaves San Francisco, that he may look more closely after personal business which now requires his attention. The Carnegie Institute join with us in regretting that he finds it impractical to continue the excellent work behind the key of WSBS. Mr. Stuart L. Seaton, W3BWL and an active member of the A.R.R.L. since 1923, has been appointed to succeed Mr. Jones. Following a brief stay in Washington and some time at the Naval Research Laboratory, Mr. Seaton will join the *Carnegie* previous to the departure from San Francisco in late August. A.R.R.L. members are asked to give Mr. Seaton the same generous cooperation and support accorded Mr. Jones during the first year of the cruise.

W1MK

A.R.R.L. Headquarters' Station W1MK operates on frequencies of 3575 kc. and 7150 kc. Robert B. Parmenter, "RP," is the chief operator; his list is familiar to most of the amateur fraternity. Occasionally other members of the Headquarters' staff operate at W1MK. Their personal signs may be found in the QRA Section of QST.

Throughout the following schedules Eastern Standard Time will be used.

OFFICIAL AND SPECIAL BROADCASTS are sent simultaneously on 3575 kc. and 7150 kc. at the following times:

8:00 p.m.: Sun., Mon., Tues., Thurs., and Fri.

10:00 p.m.: Mon. and Fri.

12:00 p.m. (midnight): Sun., Tues., and Thurs.

GENERAL OPERATION periods have been arranged to allow every one a chance to communicate with A.R.R.L. Headquarters. These general periods have been arranged so that they usually follow an *official broadcast*. They are listed under the two headings of 3500 kc. and 7000 kc.; to indicate whether the watch is devoted to listening on the 50-meter band or to the 40-meter band.

3500 kc.

8:10 p.m. to 9:00 p.m. on Sun., Mon., Tues., Thurs., and Fri.

10:00 p.m. to 11:00 p.m. on Tues. and Thurs. (No OBC sent before these periods.)

12:00 p.m. to 1:00 a.m. (or later) on Sunday night (Monday morning).

7000 kc.

10:10 p.m. to 11:00 p.m. on Sun., Mon., and Fri.

12:00 p.m. to 1:00 a.m. on the following *nights* (actually on the morning of the day following): Mon., Tues., Thurs., and Fri. (Only on Tues. and Thurs. does the OBC precede these periods.)

SCHEDULES are kept with the following listed stations, through any of which traffic will travel expediently to A.R.R.L. Headquarters. The frequency included within parentheses indicates the band in which each individual station keeps the schedule with W1MK:

W1ACH, Brookline, Mass. (3500); Sun. and Thurs.

W1BIG, Augusta, Maine (3500); Mon., Tues., Thurs., and Fri.

W1IX, Laconia, N. H. (3500); Sun. and Tues.

W1KY, Cambridge, Mass. (3500); Mon. and Fri.

W1VB, Newton, Conn. (3500); Tues. and Fri.

W2JF, Jersey City, N. J. (3500); Sun., Mon., Tues., Thurs., and Fri.

- W3AJZ, Langley Field, Va. (3500): Tues. and Thurs.
 W3BWT, Washington, D. C. (3500): Sun., Mon., Tues., and Fri.
 W3EC, Fort Monroe, Va. (3500): Thurs.
 W3SN, Fort Howard, Md. (3500): Tues. and Thurs.
 W3ZF, Ardley, Pa. (3500): Sun., Mon., and Thurs.
 W3ZS, St. David's, Pa. (3500): Mon. and Thurs.
 W4AEF, Lakeland, Fla. (7000): Sun., Wed., and Fri.
 W4OC, Durham, N. C. (7000): Sun.
 W6AKW, Lancaster, Calif. (7000): Mon. and Thurs.
 W6CIS, Sacramento, Calif. (7000): Mon. and Fri.
 K6DTG, Wheeler Field, T. H. (7000): Mon. and Wed.
 W6EEO, William, Calif. (7000): Sun. and Tues.
 W8AAG, Oil City, Pa. (3500): Sun.
 W8ARX, Ontario, N. Y. (3500): Mon., Tues., Thurs., and Fri.
 W8BYN, Columbus, Ohio (3500): Mon., Tues., and Fri.
 W8ZZ, Detroit, Mich. (3500): Sun. and Thurs.
 VE9AL, Toronto, Ont. (3500): Tues. and Fri.
 W9APY, Berwyn, Ill. (3500): Tues.
 W9ERU, Rockford, Ill. (7000): Sun. and Fri.
 W90X, Louisville, Ky. (3500): Sun. and Thurs.
 NJ2PA, Port Antonio, Jamaica (7000): Sun., Mon., and Fri.

1929 SIGNALS

- 3500-ke. band: W1MK, W2SC, W8ATP, W8CEP, W8DAQ*, W8WO, W8ZZ, W9CYQ, W9DXZ.
 7000-ke. band: W1MK, W2SR, W2UW, W3AER, W3ANH*, W3LD, W4AAQ, W4AEW, W4KV, W4OC, W4OZ, W4PF*, W4RF, W4TO, W5BBV, W6BVO, W6CQ, W6DBD, W6DCA, W8ADS, W8BML, W8CAU, W8CLO, W8CPM, W8CVQ, W8DAW, W8EB, W8HE, W8QO, W8WO, W8ZC, W9ALL, W9ARA**, W9AZY, W9BAG, W9BPT, W9CVN**, W9CXX, W9DBJ, W9DN, W9DNO, W9EK, W9EMR, W9END, W9EPH, W9ERU, W9FLB, W9FOF, W9FQS, W9FTJ, W9FVI, W9GHG, W9GJ, W9GQ**, W9PU, W9QF, W9XL, VE4HD, VE4HP, ZL1PT.
 14,000-ke. band: W6AVJ, W6AWP, W6ERK, W9ATQ, K4NE, KFR5.
 NOTE. — The stars indicate the number of extra times stations were reported.

ARMY-AMATEUR NOTES

SECOND CORPS AREA: New Jersey State Net; W2AOS has been Acting N. C. S. for 2nd Corps Area while W2SC was out of commission.
 THIRD CORPS AREA: W3SN, Fort Howard, Md., is Control Station for 3rd Corps Area. Many schedules are kept by this station on 3G12 and 7Z25 kc.
 FOURTH CORPS AREA: The 4th Corps Area deeply regrets the death of Mr. J. M. Griffin, W4KY, who was killed in an airplane crash in Cuba on June 14. W4KY was Net Control Station for 4th Corps Area, and the loss of his help as such will be felt greatly.
 FIFTH CORPS AREA: All nets in this area are working very well. W8GZ-W8ZG is Radio Aide, 5th Corps Area, and is also Corps Area N. C. S. The State Net Control Stations are as follows: Ohio, W8BAU; West Virginia, W8OK; Indiana, W9EZ; Kentucky, W9CVR, Captain Baldwin. ex-W8DKX, is the new Liaison Officer AA Radio at W2CNL.

WANTED, VOLUNTEERS

At the urgent request of numerous beginners, we are going to again devote space in this Department to list the schedules of 1750-ke. amateur stations who will broadcast information and code instruction to beginning amateurs. The newcomers to the amateur ranks need code practise more than anything else, instruction in amateur operating practise, and two-way work with patient experienced operators as soon as they secure their licenses to increase their proficiency in using their stations. Thus it is, that once again we are calling for volunteer transmitting stations in the 1750-2000-ke (150-175 meter) band.

Both C. W. and radiophone stations can engage profitably in broadcasting and two-way work for beginning "hams." Radiophone volunteers are really preferred, however, as by using both microphone and key instruction can be given most efficiently to the listeners. Last season those who took part in this work had gratifying results and built up large audiences and many friends, who listened regularly as soon as the schedules were announced. So if you have a 1750-ke. radiophone or telegraph transmitter and can engage in this most worthwhile work, please drop us a line at once, giving data on your exact frequency, hours of schedules, etc., and prepare to follow your schedule as soon as it is in print. We shall be glad to send you some mimeographed ideas and helps which will help you in putting this service over to those who copy your transmissions.

BEGINNERS, ATTENTION!

In the *Radio Amateurs Handbook* you will find useful suggestions for memorizing and learning the code. Plans are afoot for printing in QST information designed to help you get your first license and to build simple equipment for receiving the transmissions which are being arranged for your benefit. In November QST we expect to start listing the "volunteer stations" which will transmit code practise and other information for your especial benefit. A printed sheet explaining how to make a simple receiver to cover the 1750 and 3500-ke. amateur bands will be sent free of charge if you will drop a line to the Communications Department requesting this information. Be sure to ask for any other information you need, too, so that we may help out.

ELECTION NOTICES

To all A.R.R.L. Members residing in the Sections listed below: The list gives the Sections, closing date for receipt of nominating petitions for Section Manager, the name of the present incumbent and the date of expiration of his term of office.) This notice supersedes previous notices.
 In cases where no valid nominating petitions have been received from A.R.R.L. members residing in the different Sections in response to our previous notices, the closing dates for receipt of nominating petitions are set ahead to the dates given herewith. In the absence of nominating petitions from Members of a Section, the present incumbent continues to hold his official position and carry on the work of the Section subject, of course, to the filing of proper nominating petitions and the holding of an election by ballot or as may be necessary. Petitions must be in Hartford on or before noon of the dates specified, all of which are 1929.

Section	Closing date	Present SCM	Present term of office ends
Western N. Y.	Sept. 16	C. S. Taylor	July 1, 1928
Nevada	Sept. 16	C. B. Newcombe	Sept. 15, 1928
Virginia	Sept. 16	J. F. Wohlford	Dec. 2, 1928
Arizona	Sept. 16	D. B. Lamb	Jan. 3, 1929
San Diego	Sept. 16	G. A. Sears	Feb. 2, 1929
Tennessee	Sept. 16	Polk Perdue (resigned)	Oct. 2, 1930
Eastern N. Y.	Sept. 16	F. M. Holbrook (resigned)	Mar. 7, 1930
Eastern Mass.	Sept. 16	E. L. Battey (resigned)	Nov. 2, 1929
New Mexico	Sept. 16	L. E. Radka	Aug. 2, 1929
Washington	Oct. 15	Otto Johnson	Nov. 5, 1929
Montana	Oct. 15	O. W. Viers	Nov. 5, 1929

Due to the resignations of Mr. Polk Perdue, W4FI, in the Tennessee Section; of Mr. F. M. Holbrook, W2CNS, in the Eastern New York Section, and of Mr. E. L. Battey, W1UE, in the Eastern Massachusetts Section, effective at once, nominating petitions are hereby solicited for the office of Section Communications Manager in these sections, and the closing date for receipt of nominations at A.R.R.L. Headquarters is herewith specified as noon, September 16, 1929. Reports from ORS in Tennessee and Eastern Massachusetts should be sent to their Acting SCMs, listed on page 3 of QST. Mr. Holbrook will handle the work in his section until a new man is elected.

BRASS POUNDERS' LEAGUE

Call	Orig.	Del.	Rel.	Total
W9GHI	369	430	283	1082
W9FLG	123	258	227	608
K1HR	238	99	196	533
W6ASH	95	73	344	512
W6SR	373	65	12	450
W6ERK	125	62	250	437
W6ALX	101	289	40	430
W9COE	102	111	210	423
W6BVY	141	197	44	382
W6AKW	7	9	366	382
W3EC	214	37	130	381
W1MK	65	65	209	339
W6EEO	41	218	76	335
W3BWT	33	55	236	324
W3ZF	41	53	227	321
K6DU	262	35	4	301
W6DTU	154	31	98	283
VE2AC	85	69	113	267
W8DYH	48	58	133	239
W8GZ	21	18	196	235
W6EIB	8	15	211	234
K6DWS	18	39	174	231
W6CHA	25	176	27	228
W8BML	197	15	8	220
W8CMB	18	20	180	218
W8JD	32	45	134	211
W6IP	79	24	108	211
W6CBW	68	16	126	210
W6EQF	33	148	24	205
W2QU	101	94	—	195
W6AHP	28	60	104	192
K1AF	59	54	78	191
W6ETJ	32	84	54	170
W6BYJ	40	65	20	125
W9CJL	37	56	26	119
W6AFU	11	55	46	112
W5RJ	16	54	38	108
W7KO	49	61	—	110
W6CGM	10	60	16	86
W6HJ	7	37	—	64

The several amateur stations responsible for the best traffic work — the ones that are "setting the pace" in worthwhile traffic handling — are listed right up near the top of our B.P.L., the figures giving the exact standing of each station accurately.

All these stations appearing in the Brass Pounders' League are noted for their consistent schedule-keeping and dependable message-handling work in amateur radio. Special credit should be given to the following stations (in the order listed) responsible for over one hundred deliveries in the message month: W6ALX, W6BVY, W6CHA, W6EEO, W6EQF, W9COE, W9FLG, W9GHI.

Deliveries count! A total of 200 or more bona fide messages handled and counted in accordance with A.R.R.L. practice, or just 50 or more deliveries will put you in line for a place in the B.P.L. Why not make more schedules with the reliable stations you hear and take steps to handle the traffic that will qualify you for B.P.L. membership also!

28 Mc.

W9EJQ says that every alleged 28 mc. station he has heard has been near WQA, some signals below and some above. QST gave WQA's frequency as 21.2 mc. which he checked as the third harmonic of 7070 kc. using an oscillator and a 7000-band frequency meter. Will some one please advise if the entire 28 mc. gang has mistaken the third harmonic of 7000 kc. for the fourth or if WQA has actually moved to 28 mc. — it's got to be one or the other.

ef8SM (Toulouse, France) transmits on 28 mc. and listens over a wide band in the vicinity of this frequency for fifteen hours or more daily according to a message just received from him via W1AEP. ef8SM will appreciate the cooperation of North American experimenters in his 28 m.c. work.

"I am ready for tests on 28 mc. daily at 8 a. m., 1:30 p. m. and 7:15 p. m. Several stations are heard here — W5AOT, W6UF, W6CUH, W9DKM, and W9EVC with whom I have a schedule. I shall be glad to hear of stations operating week-days so that more extensive tests may be conducted — VE2AC-2AS."

"G2OD, G6LL, G2KE, WG17C*, G6YQ*, G5VL, GW18B* and G2FN* have been QSO your stations. Those marked (*) use less than ten watts input! G2FN has worked the sixth district on eight watts input and W2JN has heard G6DH with an input of three watts! G6WT has heard ea2AZ calling CQ on this band. Our stations are on the air each Sunday afternoon looking for W men. We don't seem to hear any W stations during the week but let us have the schedules and we will announce them so our boys can look for them. I have heard W1BLV, W1CH, W1BSU, W2BAC, W2BJV, W2CDR, W8CPR, W9BGQ and K4AGF all at very good strength. — G16YW, T. P. Allen, Belfast, N. I."

"For the past three weeks I have not been able to hear any European amateur signal on the 14,000 kc. band. But on 28 mc. FB each week-end. The sigs, however, are quite erratic and seem to fade a good deal more than they used to back in January and February of 1928 while working ef8CT. Have noticed from ef8CT's signal the last two week-ends that he would have come through very well from 1400 to 1430 fade out — and then swing in again around 1515 GMT, lasting until about 1630. This period during which the signal fades out is apparently at a time when it is 'high noon' in mid-Atlantic. (Heard): PCRR, WGT, W5OH, W5AOT, W6UF, W6BAX, W5WZ, YR (2nd harm), G5ML, W9EVC, W9AKM, W5AEC, W9DKM, VE4GQ (Worked): K4AGF, G6LL (solid), EO17C, G2FN, ef8CT, G6YQ, G5VL, G5ML. — 2JN."

"I am still pounding away on 28 mc. and have worked many more stations. It is now so easy to establish contacts on 'ten' that I believe that the ten-meter column is no longer necessary unless it be reserved for unusual work. Possibly a ten meter section in the 'calls heard' list would be of interest. — W1AQD."

Calls heard 'n England on the 28 mc. band: (By G2CX) wlaqd w1bjd w1zl w2jn w2bda w2alo w4md w2zg w2xt w6uf w6vx g6ii g2od g2kf g5wk g6hp. (By G2FN) wlaqd w1cui w2acn w2aol w2ayr w2azo w2csw w2ejv w2jn w2pt w5wd w6uf. (By G16YW) w1blv w1bsu w1ch w2bac w2odr w5cpr w9bgq k4agf. (By BR255) w1xam w2acn w2bda w2bc w2bd w2bjv w2jn w5uz. (By G6LL) wlaqd w1xam w1zl w2acn w2ayr w2bda w2bg w2bjv w2bug. (By G5SY) w1xam w2ay w2bd w2bda w6uf. (By G6WT) wlaqd w2aol w2bjv w2bv1 w2jn w6dwp oa-2az eur625. (By G2BXM) w1xam w1rv w2aay w2bg w2bjv w2xc w6rf ef8ct. (By G5VL) w2acn w2jn. (By GW17C) wlaqd w2acn w2avg w2bjv w2jn w2pt.

"One idle Saturday afternoon in the past month, I digested quite a bit of 28 megacycle literature via 'QST.' Having a little junk lying around, I proceeded to build a set that would bring in some ten meter stuff. Being only mildly curious, I just used a lone 199 in a detector and that was all. The only thing stumped me was the number of turns needed. I first tried three which brought in nothing but a few sparsely separated commercials below our present 14,000 kc. band. A single turn was next taken off. Behold — the first station to hop out of the cans R8 and bite me was none other than W6ZZD. Well, you can bet for the next half hour, I was pretty busy. Within that half hour, I logged every district in the United States except the fifth and seventh and also heard one English amateur. As for skip effects, I heard stations right within the same town line and stations within two hundred miles came in FB. I have only two criticisms to make and they are namely: not enough stations there and absolute disappearance of stations at nite except for locals. This band, I believe, will outshine any other band for DX communication with lower power than any of our other bands. Please print more on ten meter receivers and trans-

mitters. Let's give 28 mc. a great big hand for 1929 — W3AUM."

"In the past month work has been very good and certain conditions have been observed that seem to contradict our first impressions of this band. On several occasions I have been able to carry on good QSO with W6AM and W6CUH during a heavy rain. Also, of late 28 mc. signals are audible up to two hours after dusk instead of fading out at about four p.m. C.S.T. In the past three weeks I have worked W6VZ, W6AM, W6JU, W6UF, W6TS, W6CUH, and W6CUI. To show how simple it is to work on this band I put up an indoor antenna 30 feet long and ten feet above the ground, energizing it at its second harmonic by a series-fed split Hartley oscillator. This has put good steady signals through to the west coast on different occasions. It is my belief that within a short time, outdoor antenna systems of bulky proportions will be done away with, and international contacts will be effected using small indoor antenna devices and directional loops. (Comments on this thought are invited) — W9EF."

Please report the time of day and duration of all 28 mc. contacts so we will know the characteristics of this frequency.

Official Broadcasting Stations

CHANGES AND ADDITIONS

(Local Standard Time)

W5KX (3515) Mon. 5:30 and 11:30 p.m.; W7PH (14,000 band) 4 p.m., (7000) 7 p.m., (3500) 8 p.m. (radiophone) daily except Sunday; W9EPX (xtra) (3500) 6 p.m. and 9 p.m.; (7000) 12:30 p.m. daily.; W8CNZ (7015) Mon., Wed., Fri., 9:30 p.m.

TRAFFIC BRIEFS

W6AKW worked W1ZZA at noon while he was at Williams, Ariz.

Mr. A. W. Travers of Tientsin, China, recently made good use of ham radio by requesting literature from the Enterprise Oil Co., Inc., Buffalo, N. Y., via radiogram. This was one of the most interesting requests ever received by the company and the data went forward promptly. The message travelled from Tientsin to Baguio, P. I., and then to W6AMM, who delivered.



Another Headquarters Change

In addition to the changes in the QST staff which were mentioned in last QST, the A.R.R.L. field organization will be interested in some Communications Department news. We announce with regret that Mr. Louis K. Huber has resigned his position as Assistant to the Communications Manager to vacation in Iowa and to continue his college work in the fall. Just at present Louis is busy "reactivating" his station W9DOA and we understand that he will be active in Midwest Division affairs.

Mr. E. L. Battey, formerly Section Communications Manager of the Eastern Massachusetts Section will succeed Mr. Huber, resigning his office in the field to come to Headquarters. Everett is equally well known as Section Manager and as "EV" at his station W1UE which will be on the air in Hartford very shortly. You will recognize him by the same "sine" when he operates Headquarters station W1MK.

Report on 1929 signals from W8ADS. "None. I.C.W. in 7000 kc. band: W8BSL, W9EPX, W5JR, W8AA, W8DUW, W9DN." Similar I.C.W. report from W8LL, "W8OK, W8AA, W8FP, W3APF, W8SS, W8DUW (worst)."

TRAFFIC BRIEFS

W6AM offers a good suggestion to those amateurs who travel: On his trips across the country he wires ahead to hams in the more important cities where the train stops to meet him at the depot. In this way he has time either to visit the local stations or have a good rag chew before the train moves on. FB Try it, travellers!

Inexpensive notebooks take up much less room around the shack than loose papers and are not so easily lost. They are excellent for use when copying messages. W2BIV has separate one for originated, delivered and relayed traffic.

Rather than waste time blindly thumbing the pages of your call book searching for a certain district, why not index the book with numbered tabs?

California and New Zealand traffic may be routed through W4AAQ who keeps a regular schedule with San Francisco and works ZL and VK consistently.

Mr. Leo G. Sands, W7PH, 2119 McDougall Ave., Everett, Wash., will broadcast code practice to beginners, if schedules are made beforehand Write him, if interested, fellows.

W8XE, the well-known call of the Pennsylvania State College, has been changed to W8YA. The call W8XE had been held since 1914.

W8DNO took a message from Spain and made delivery at Uniontown, Pa., in 48 hours. FB, OM!

Most all stations are favored with visits from brother hams during the vacation season. It is an excellent opportunity to make plans for the coming cold weather. Why not take advantage of the chance and make schedules with your visitors before they leave? In that way you can make some skeels which you know will be real stuff.

Many amateurs have formed the habit of running the filaments of transmitting tubes below the rated voltages, thinking that by so doing the life of the tube will be lengthened. In a number of cases we have seen tubes run at full output rating with the filament voltage half to two-thirds of a volt low. In most such cases a slow paralysis of the filament has slowly been effected, necessitating reactivation of the tube at an early date. The life of thoriated filaments depends more than anything else on the treatment they receive during operation. It is important, to secure best results and longest useful life, to run the filament at normal

voltage, that is, to run the tubes as nearly as possible at the rating given by the manufacturers.

W3IS, W3IX, W3AGT and W3AUE, all of the College Amateur Union, are playing chess and checkers with other C. A. U. members on ten meters. W3ACY is national headquarters of the Union. Any station wishing to join should communicate with W1YB, W2HJ, W8CFA or W9SO.

VE3VC recounts the following: One night while listening in the low frequency commercial bands he tuned in on a message from W— (call withheld) being received by WBL. This message was filed by an amateur, signed with his call and had reference to another amateur call. W— counted both calls as one word each in text and signature. WBL questioned this, stating that mixed letter and figure groups count a word per letter except in address. After some arguing W— said, "Please cancel that message, customer's request." Apparently the amateur who filed the message at W— had argued the operator into accepting the message with the calls counting one word each.

CANADA

Nominating petitions for Section Managers in Canada should be addressed to Canadian General Manager A. H. K. Russell, VE9AI, 5 Mail Building, Toronto, Ontario. To be valid, petitions must be filed with him on or before the closing dates named.

British Columbia Sept. 16 E. S. Brooks Dec. 2, 1928
 Saskatchewan Sept. 16 W. J. Pickering Dec. 2, 1928
 Maritime Sept. 16

To all A.R.R.L. Members residing the Sections listed:

1. You are hereby notified that an election for an A.R.R.L. Section Communications Manager, for the next two-year term of office is about to be held in each of these Sections in accordance with the provisions of By-laws, 5, 6, 7 and 8.

2. The elections will take place in the different Sections immediately after the closing date for receipt of nominating petitions as given opposite the different Sections. The Ballots mailed from Headquarters will list the names of all eligible candidates nominated for the position by A.R.R.L. members residing in the Sections concerned.

3. Nominating petitions from the Sections named are hereby solicited. Five or more A.R.R.L. members residing in any Section have the privilege of nominating any member of the League who holds an O.R.S. appointment in their Section as candidate for Section Manager. The following form for nomination is suggested.

(Place and date)

Communications Manager, A.R.R.L.
 1711 Park St., Hartford, Conn.

We, the undersigned members of the A.R.R.L. residing in the Section of the Division hereby nominate as candidate for Section Communications Manager for this Section for the next two-year term of office.

(Five or more signatures of A.R.R.L. members are required.)

The candidate and five or more signers must be League members in good standing and the candidate must be the qualified holder of a Communications Department, Official Relay Station appointment of the petition will be thrown out as invalid. The complete name, address, and station call of the candidate should be included. All such petitions must be filed at the headquarters office of the League in Hartford, Conn., by noon of the closing date given for receipt of nominating petitions. There is no limit on the number of petitions that may be filed, but no member shall sign more than one such petition.

4. Members are urged to take initiative immediately, filing petitions for the officials for each Section listed above. This is your opportunity to put the man of your choice in office to carry on the work of the organization in your Section.

— F. E. Handy, Communications Manager.

ELECTION RESULTS

Valid petitions nominating a single candidate as Section Manager were filed in a number of Sections on or before the closing dates that had been announced for receipt of such petitions. As provided by our Constitution and By-laws, when but one candidate is named in one or more valid nominating petitions, this candidate shall be declared elected. Accordingly, election certificates have been mailed to the following officials:

Section	Address	Two-year term begins
Manitoba	A. V. Chase, VE4HR 109 Lanark St. Winnipeg, Man.	July 15, 1929
Arizona	H. R. Shortman, W6BWS 519 W. Madison St. Phoenix, Ariz.	July 15, 1929
Porto Rico-Virgin Isles	E. W. Mayer, K4KD Box 103, Enseada, P. R.	July 15, 1929
Eastern Pa.	Don L. Lusk, W3ZF Box 188, Ardsley, Pa.	July 15, 1929
Md.-Del.-D. of C.	Forrest Calhoun, W3BBW 1636 Thomas Ave. Baltimore, Md.	July 15, 1929

In the North Carolina Section of the Roanoke Division, Mr. F. M. Whitaker, W4OC, 816 Wilkerson Ave., Durham, and Mr. Hal S. Justice, W4TS, Box 552, Canton, were nominated. Following a close election Mr. Whitaker withdrew his name in favor of Mr. Justice who has therefore been declared elected, his term of office beginning July 31, 1929.

TRAFFIC BRIEFS

One way to keep the station on the air after you are married is to marry a YL ham. OM W9EHN had that all doped out when he married YL W9FIW, FB and good luck!

On June 4th VE3ET played a game of checkers via radio with W4ABV. The game took just 50 minutes and VE3ET came through the victor. FB, OMs.

Let's have more lists of High Quality Signals and Well Operated Stations. And say, OM, is your call listed under that heading?



TRAFFIC BRIEFS

W9BSH says that those fellows working FLIAB and desiring a QST, should write to Operator L. O'Clery, in care of the American Legation, Monrovia, Liberia, West Africa.

56 mc. (5 meter) contact over a distance of 170 miles is reported to us by the Contact Bureau of the Radio Society of Great Britain. The transmitting station in this instance was G6TW. The receiving station was BRS 125. Power used was 25 watts. The date of the contact was 19 May 1929. FB — come on, America!!

NDZ is a Naval Reserve drill station and may be heard every Thursday night on 4045 kc. at 7:30 p.m., C.S.T.

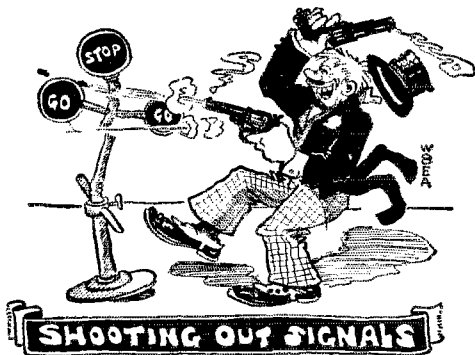

DIVISIONAL REPORTS

ATLANTIC DIVISION

MARYLAND-DELAWARE-DISTRICT OF COLUMBIA — SCM, Forrest Calhoun, W3BBW — Maryland: W3BBW has fallen by the wayside. Hi. But look out this fall. W3BCX has moved his transmitter, W3AMF, to W3BBW's shack. W3MH has been operated on. Here's wishing you a speedy recovery, OM. W3AJR, our latest ORS, is sure stepping. W3AFF in Cumberland wants skeds. W3APX is with us again and handled some traffic. W3ADO, the Naval Academy Radio Club station, is on with D. C. Delaware: This state is surely poorly represented. Won't some of the fellows send in reports, whether you are ORS or not? W3AJH spent two weeks with the Naval Reserves at Bethany Beach and had a fine time. District of Columbia: We have another old-timer back again, ex3EE, now W3AVH. He wants an ORS. W3BWT leads us all this month and makes the BPL, FB, OM, W3ALF is on again, and has a YL op at his shack. Steady, OM. W3AHP says that screen-grid tubes lose their sensitiveness after a moderate period of operation. Let's hear more about this.

This month less than half the gang reported. Another month like this and I'll get the broom out for another clean-up. So let's have those reports.

Traffic: W3BWT 324, W3AJR 53, W3ALF 29, W3AHP 21, W3AVH 16, W3AJH 6, W3BBW 1.

EASTERN PENNSYLVANIA — SCM, Don L. Lusk, W3ZF — Greetings, OM! I want to thank all concerned in electing me SCM. I shall always give you my best, and if you will cooperate by sending in snappy up-to-the-minute news items and traffic reports, it will help a lot toward making this section outstanding. Please note my new QRA, given on page 5 of QST. Several reports went to my old address and were not received in time to forward to QST. Raymond Rosen Co., 49 North 7th St., Philadelphia, has several hundred handy reference sheets containing the new International prefixes and "Q" sigs. A request to them will bring you one by return mail. Thanks are due W3PB for this. Miss W3AKB says that her vacation has QRM'd traffic, but promises a much better total next month. W3CDS reports no traffic. W3NF, our RM, has been busy organizing the Lehigh Valley Radio Club, and is looking for new members. W3AFE has been working 3.5 mc. and handling traffic. W3ATS is trying to get an 852 perking on 14mc. W3KS has a good fone on 3.5 mc. W3CJN and W3ADX are doing good work on 14, 7 and 3.5 mc. W3AWB is doing quite a bit of DX work, W3VD complains of QRN hurting his totals. W3LC blew his junk, but is back on now. W3DHT complains of inactivity in his parts. W3CWO, now in Chicago, is ready to use his new call W9BVZ and requests temporary QSK of ORS. W8AWO left on his vacation, but sent his report in. W3BQ made his first report. W3RO is trying to break into traffic circles. W3ZF makes the BPL.

Traffic: W3ZF 321, W8VD 32, W3AKB 39, W8AWO 10, W3DHT 12, W3LC 27, W3NF 16, W3BQ 23.

WESTERN NEW YORK — SCM, C. S. Taylor, W8JP — W8DME and W8BRP have been handling traffic. W8BGN has been searching the ether for old-timers and chatting with same. W8BHK worked Byrd expedition WFA, PY, EAR. W8BJO also worked WFA. W8DII is handling traffic. W8DOA uses a self-starting Overland engine for power plant. He handled some traffic for the famous aviatrix, Lady Mary Heath, while she was in this country. W8DQP has his sister in training, so we may hear another YL soon. He has his ORS again and reports traffic. W8DRJ is now an ORS. He uses TPTG circuit and a 50-watt P.A. W8DSP is handling traffic from his Syracuse station. W8JH a new ham in Western New York reports. W8PJ has just returned from a cruise on board the U. S. S. *Flusser*. Shake off the dust, gang, and put pep into the district report on the 15th of each month.

Traffic: W8BBP 5, W8DII 9, W8DME 11, W8DOA 13, W8DQP 2, W8DRJ 14, W8DSP 7, W8DH 6.

SOUTHERN NEW JERSEY — SCM, M. J. Lotysh, W3CFG — The SCM regrets no report was sent in last month due to his being away on vacation. Only W3ATJ and W3KJ report this month, and neither handled any traffic. Now is the time to do your rebuilding for fall, so let's get it out of our system early. W3CFG is in New York City as a technical operator on the transatlantic telephone circuits, and only gets home over week-ends. His totals will be missed. Let's have more reports from now on.

WESTERN PENNSYLVANIA — SCM, A. W. McAuly, W8CEO — A fair number of reports came in this month despite poor radio weather. W8CUG was on for only two weeks, but he leads the bunch, nevertheless. W8BNN runs a good second. He is going to Chicago to school. W8CFR and W8CNZ have a perfect record for reporting. W8CEO will have to move his transmitter again on account of mill building changes. W8XE have had their call changed to W8YA. W8DHW reports no success with 5-meter tests with Great Britain. W8DVZ is calling for traffic. W8DKS has a new Zepp antenna. W8CNZ and W8CEO tried hard to pick up KHEJ, but failed. W8AMU is rebuilding. W8CQA is applying for an ORS. W8DLG is cracking crystals in his spare time. W8DNO has a new outfit working on 14,000 kc. W8BHN reports a fine time at the Philly Convention. Although the committee has not given out the date of the Annual Banquet of the Erie Amateur Radio Club, they have stated that there will be no rubber chickens this year. Hi. W8AVY is requested to send his correct address to the SCM for check. W8AYH has been visiting in Erie. Thompson, recently an operator at W8AGQ, is putting his station. W8AJE, on the air. W8AJU is active again. Better weather coming, gang. Let's get set.

Traffic: W8CUG 69, W8BNN 54, W8CFR 41, W8CEO 27, W8YA 24, W8DHW 13, W8DVZ 12, W8DKS 10, W8CNZ 6, W8AMU 4, W8CQA 23, W8DLG 8, W8DNO 5, W8AVY 4, W8AYH 3.

CENTRAL DIVISION

KENTUCKY — SCM, J. B. Wathen, III, W9BAZ — The extremely hot weather accounted for several absences this month. Some very nice totals were turned in, however, W9EKM opened up at home with big stuff. W9JL is off for the summer. Although W9BXK dropped all skeds for the summer, he still ran good total. Business won't let W9RWJ come home yet. W9FQN says he has the best xmitter in town. We're from Missouri on that. OM, W9AZY got most of his traffic from K6CYC on sked. W9FZV is getting his skeds all lined up for the fall. A new ham opening up in Danville says W9GGB did everything but learn the code for him. HI, W9GJJ has built a portable for use in Asheville, N. C., where he has been banished by his doctor. Take care of yourself, OM. W9BGX continues the good work with another fine total. He is half owner in a \$10 Ford. W9FBV promises a photo of his outfit to every station that sends in DX reports of his sigs. W9FKM rises to remark that he passed his exam. W9BAN is playing tennis with local postmaster to insure quick delivery of ham mail. FB, Get your reports in early.

Traffic: W9EKM 122, W9AZY 45, W9BXK 30, W9FQN 28, W9GBX 21, W9FBV 21, W9BAN 19, W9GJG 7, W9BAZ 6, W9FZV 2.

WISCONSIN — SCM, C. N. Crapo, W9VD — W9EMD is not keeping many schedules, but keeps quite a bit of traffic moving. W9BWZ has schedules with W9EK and W9BKL (shh — she's a YL in Chicago). W9EFX is improving his station and now uses a 210 Hartley on 7000 and 14,000 kc. W9BIB is on occasionally, and says radio weather comparatively good lately. W9DLD has a weekly pow-wow with W9ERU every Sunday, and attended a hamfest at Rockford, Ill., on July 4th. W9FSS has discontinued all schedules. W9ASL operates occasionally on 14,000 kc. W9DJK-W9CVF is operating on 7000 and 14,000 kc. during the summer. W9FHU says he is busy haying. W9DTK starts on Great Lakes cruise July 27th and will be gone two weeks. W9DKA expects to be on the air all summer.

Traffic: W9EMD 52, W9BWZ 33, W9EFX 11, W9BIB 10, W9DLD 10, W9FSS 8, W9DTK 41, W9DKA 3, W9DJK 2, W9FHU 2.

ILLINOIS — SCM, F. J. Hinds, W9APY — Stations reporting seem to be holding their own in spite of the usual summer slumping of traffic. FB, W9PU worked WFA and ZL this month with his new 852 and 210 MOPA. W9FZE is rebuilding. W9BVZ (also W8CWO) is located in the DC district and is having a tussle getting some power supply. W9BNR is making schedules. W9ACU is using B battery supply on a 171A. W9IZ blew a few more 281's on 14,000 kc. W9CZL states his new tube is going along fine. W9BRX is operating on the S.S. *Carolina* (WPCV). W9ALW is using a Zepp and a 210. W9BNI did a little globe trotting, visiting W9DCK, W9BCA and the boys in Rockford. W9AFF has his 852 on the 20-meter band with 500-watt 4000-volt kick in a voltage doubling circuit. He worked OA-4QFB, getting a report of QSA4. W9CUH is also on 14,000 kc. W9DCK is rebuilding for the 3500 band. W9DCK says no DX to speak of this month, but traffic is good. W9AFB is quitting his self-excited circuit and is putting in a MOPA. We have two new ORS prospects in W9BEF and W9AFN. W9AFN has a 210 in a 1929 hi C Hartley. The Austin "Y" Club has turned out two new hams under the supervision of W9GJ, FB, OM. W9GJ wants to find out what the gang thinks of a station that uses the 7000-kc. band for testing purposes at night, sending such stuff as magazine clippings. Cut it out, gang. There is enough QRM without that. W9CKZ is not quite done with his new receiver and transmitter. W9AKL is a member of the College Radio Union. W9AVL has hot attic QRM. W9FCW worked his first foreign station on July 4th. HI, W9BMC is being rebuilt for a busy fall season. W9AII wants to know what to do with a present of 3 five-watters. HI, W9GIV is a new ORS. W9GV and W9AAS are knocking down DX records in fine shape. W9ERU is getting ready for fall features by obtaining some good schedules — he says a U. S. N. R. unit will soon be started in Rockford. W9DII is working Australia regularly. W9BZO is rebuilding, which, together with a nice crystal, will make him a "star" traffic man this coming season. W9FDJ is going to do what W9BZO is doing. HI, W9BKL has a new 203A, and

is again going along in fine shape. W9FDY and W9AHK and W9KA have been operating on cruises on the lakes — USNR. FB, W9GJJ is building a four-tube screen-grid outfit. W9AHK is doing nicely in the A-A Nets. W9CNY was one of the few who heard the Chicago *Tribune* plane "Untin Bowler" before she was lost. The Fox River Relay League has had their convention, and it was a very successful meeting. The boys had a fine time.

Traffic: W9GIV 57, W9AHK 40, W9CZL 31, W9AFN 27, W9DCK 23, W9AFB 21, W9FZE 18, W9ERU 17, W9BNI 16, W9DCK 16, W9FDY 15, W9APY 14, W9FDJ 13, W9GJ 13, W9BKL 12, W9KB 11, W9ALW 10, W9CUH 10, W9IZ 8, W9AFF 7, W9BNR 7, W9FCW 7, W9BZO 5, W9ACU 4, W9BEF 4, W9GJJ 4, W9KA 4, W9AAW 2, W9BRX 2.

OHIO — SCM, H. C. Storck, W8BYN — Pleasant surprise was registered on this SCM's face when three hams made the BPL this month, one of whom is not even an ORS as yet. This went far to mitigate the disappointment caused by the rest of the reports. When SOME hams can get the traffic, and have good totals, it behooves every ORS to have something besides a zero to report. QRN is fierce on the 3500-kc. band, and more and more kicks are being registered about ICW, AC and broad RAC QRM on the 7000-kc. band, but the fact remains that some can get the traffic, nevertheless, and the rest could at least get a little if they tried. W8GZ leads OHIO this month and reports lots of schedules and nice A-A work. W8BML, runner-up for ORS, was not satisfied with his progress in getting traffic out of the air, so he worked like a trooper, canvassing for messages, and made the BPL through good honest work. FB, W8CMB is the third one who made the BPL. Good hunting! W8CRI turned in a good total, though he has been very busy with engineering. Now is the time to get things lined up for the coming season and W8CRI, W8CMB and W8BBR stand ready to help you with schedules, so don't forget to call on them and the SCM. W8AYO reports a daily schedule with PYIAW and works in the 14,000-kc. band. W8CWC has been busy taking care of his father's business. W8DDF and W8PV turn in totals for a few days' work. W8BAC says traffic is dead as a door-knob. HI. Here are the joys of a ham's married life. W8BKM reports that W8DTC's wife broke up the whole outfit and DTC is now off the air for a while. W8AQ has been working 14,000 and now is again on 7250 kc. W8CSS says he is waiting for fall as it's too hot to work. W8ADS is one of the very few who reported on good signals. Let's have more of them. Between QRN, a local phone station and his YL, W8CITY is not getting on the air much. W8QU will be an ORS soon. W8DBK turns in his first total and is runner-up for ORS. W8BOR has been busy with radio service work. W8CFL reports: "Baseball plus golf plus work equals no traffic," but turns in a total just the same. HI, W8OQ has nothing to say for himself. W8LI registers another kick about the ICW signals. W8APB is on the 14,000-kc. band altogether now. W8CC's reports acquiring a new Ford. W8CNU has no news for us this month. W8BBR is still disgusted with conditions. W8DVL has changed his QRA and is now in Cleveland. We are sorry to report that we lose W8DIA as an ORS and the game loses him as a ham. His business takes so much of his time that he has dropped out altogether. W8CQU is operator on board the S.S. *Huyuenol*, KIVQ. W8CNO hopes to be going again soon. W8CMU is getting his set ready for the air races. W8BBH is going good. W8BKQ has been moving and rebuilding his transmitter. W8RN is still on WTBL, W8PL, W8ALC, W8DPF, W8DHS and W8DDK report nothing unusual. W8BYN is looking forward to an active season this winter. Let us try to make this coming season the best ever. Send in more reports on good signals.

Traffic: W8GZ 235, W8BML 220, W8CMB 218, W8CRI 52, W8AYO 32, W8CWC 28, W8DDF 27, W8PV 26, W8BAC 20, W8BKM 19, W8AQ 15, W8CSS 14, W8ADS 14, W8CITY 12, W8QU 11, W8DBK 8, W8BOR 6, W8CFL 5, W8OQ 4, W8LI 4, W8APB 4, W8CCS 3, W8CNU 2, W8BBR 2.

MICHIGAN — SCM, Dallas Wise, W8CEP — W8WO is working on 3500 kc. and handling some traffic. He is building a 14,000-kc. set, using crystal control. W8SS is a newcomer in Detroit. W8BRO, W8ZZ, W8DAQ, W8CAT, W8SS reported via radio through the RM, W8DYH. W8ZZ

has a little crystal-controlled outfit using a couple of 210s that get out fine. W8DAQ is pounding through in great shape. W8PF of Monroe reports good results from an 852 with UX866s for rectifiers. W8BGY is getting to be quite a DX hound, but turns in a nice total just the same. W8DYH has the honors for this month and is keeping seven daily schedules. Earl Seeley of W8CKZ hasn't been very active, but he didn't forget to report. W8RBS reports being QSO with our old friend W8DKX, who is now at W2CXL. W9AXE is pushing a 210, but expects to have a fifty soon. The steamer Stellaris now has W8AUB at the key. W9BTQ will soon have a new shack and be on 3500, 7000 and 14,000 with two new transmitters. W8JD had some hard luck with the plate supply, but is all FB again. He has handled a great deal of Army traffic. W9EGF the op at WHDF at Calumet reports that they will move to a new location soon. W8SE is leaving for a three-year trip to Russia. Best of luck, OM.

Traffic: W9EGF 6, W8JD 21L, W8ACB 3, W9BTQ 20, W8AUB 3, W9AXE 11, W8RBS 15, W8CKZ 8, W8DYH 239, W8BGY 64, W8PP 11, W8WO 11, W8ZZ 50, W8DAQ 77, W8CAT 18, W8SS 5, W8BRO 70, W8CEP 120.

INDIANA — SCM, D. J. Angus, W9CYQ — Report compiled at Headquarters. W9EY had a visit from W9EWV and W9DXN. W9EXW is doing some rebuilding. W9PF has schedule with W9DAQ and W9EVB. W9DELJ is also rebuilding for cooler weather. Reports were received from W9AIN and W9FCG.

Traffic: W9EY 71, W9EXW 23, W9AIN 17, W9FCG 5, W9DHJ 4, W9PF 1.

DAKOTA DIVISION

NORTHERN MINNESOTA — SCM, Carl L. Jabs, W9BVH — The usual summer slump is here. Only four stations reported traffic. W9BCT comes to the front with a nice total. W9C1Y has his transmitter fixed so he can work 3500, 7000, 14,000 kc. W9EHO received the SCM's traffic from W7AII and delivered it. W9DOQ is rebuilding. W9CF has QRM from his new Ford. W9EHI is back on the air. W9BBT had a visitor, W5AMV. W9EGU is on occasionally and says he had a great time at Great Lakes. W9CKI is too busy with low frequency radio to work high frequency, but will soon be on with a transmitter that will knock 'em all dead. The SCM just returned from a five weeks trip to the west coast, covering a distance of 7500 miles. Lack of time prevented him from visiting many hams, but he managed to visit W7AEK, W7PP, W7AAX and W6AM.

Traffic: W9BCT 100, W9C1Y 14, W9EHO 8, W9DOQ 2. NORTH DAKOTA — SCM, B. S. Warner, W9DYV — Not a single ORS reported this month! It's probably the hot weather and vacations, but without the reports the SCM cannot use our space in QST to good advantage. Please try to send in the card, fellows — it only takes a couple minutes!

SOUTH DAKOTA — SCM, Dwight Pasek, W9DGR — W9DLY is putting in lots of time as a printer's devil and is coming out of his summer slump at the same time. W9DB had some company and, contrary to all experience and expectations, 9 out of 12 foreigners called were clicked with. He reports some activity by W9FOQ on 14 mc. W9EUI is on 7 mc. and wonders where the So. Dak. gang is at noon. W9DLY was the only Soo Falls station to report. The rest of the gang is presumably on vacations and in the summer slump. Don't wait too long, fellows, before you start in. We want to make a good showing again this year.

Traffic: W9DB 9, W9DIY 5, W9EUI 4, W9DLY 2.

SOUTHERN MINNESOTA — SCM, J. C. Fehoushek, W9EFK — W9EOH has cobwebs gathering on the transmitter, but he leads the section. Hi, W9BKX is rebuilding. W9AMK has a 1929 transmitter that makes the journey from 7 to 14 mc. in 15 seconds. W9COS has a sked with KFR6, whose dad is at Rochester. W9DGE is on the same boat as last year and pounding lots of brass on the low frequencies. W9EYL has a new Ford. W9DBW is again on and handling a few. W9AIR, our official hamfest instigator, has gone for a trip to the Black Hills and points west. W9DHP is getting back on as soon as the new Rectobulbs arrive. W9FCG is still in Wisconsin and on using 400 volts B bats. W9DMA's transmitter is like most women. He never knows what it's going to do next. W9EFK is at a new location.

W9DBC says a combination of car, YLs and a tough job makes for low total. W9FLE, a new nut at Vesta, is keeping a couple of skeds. FR. OM. W9DQH another new Minneapolis ham is getting out nicely with a 1929 Hartley and one UX-210. W9C1X and YLs are still synonymous. W9BHZ has been heard on a few times. W9ELA handled a little traffic and worked some DX. The SCM had a most pleasant trip through Northern Minnesota and Canada and visited W9EUD, W9ZC, W9FUO, W9EGN, W9EGU, W9DIU and VE4DU. The TCRC has elected next year's officers and promises a convention sometime next spring. Any suggestions as to program, speakers, dates, etc. will be welcome by the Convention Committee. Reports on the 16th SURE and send 'em to my new QRA, 60 Melbourne Ave., S. E., Minneapolis, Minn.

Traffic: W9EOH 21, W9BKX 15, W9AMK 12, W9COS 4, W9DGE 1, W9EYL 1, W9DBW 24, W9AIR 21, W9ELA 18.

DELTA DIVISION

TENNESSEE — SCM, Polk Perdue, W4FI — The SCM is very sorry that he must resign his appointment. He has made connections with WAPI, Birmingham, Ala., and is leaving WBAW, August 1st. Send your reports to James B. Witt, 832 N. Fifth Ave., Knoxville, Tenn., until further notice. W4AJQ has been busy, but will be on soon. W4RP is back in Memphis. W4CA has a 50-watt and MG perking 'E. W4MC has xmitter and receiver built in suitcase, using UX250. W4AC keeps skeds with 1N1C and Panama. W4DR is on with UX-210. W4ACP has turned commercial on air. W4AGW forgot to renew. W4AHK gets FB reports with UX-210. W4BU has a 250-watt with MG supply. W4DI is not at home key regularly as he is commercial op. W4GH will try for commercial ticket. W4AIQ has 212-D with mercury arc on 7000, UX-210 on 14,000, and gets good DX. W4QB is on the sick list. W4KH has bad power supply. W4CW is a new station at Buntyn, using a UX-210. W4AFK is putting in crystal and high power. He reports DX FB on 14 mc. and wants tests on 28 mc. W4AGZ is off for the summer. W4AGV has rebuilt and wants traffic. W4WZ, ex5AMK, a new station at Lawrenceburg, is rebuilding to use crystal and more power. W4SF is getting ready for winter. Well, gang, the SCM wishes you good luck, DX, and hopes to QSO from WAPI. Stand by your next SCM, OMs.

Traffic: W4RP 12, W4AJQ 4. MISSISSIPPI — SCM, J. W. Gullett, W5AKP — W5AED filed application for an ORS, but failed to send in a report. W5FQ failed to report this month and, if he fails next month, he will be minus an ORS certificate. W5BDE is figuring on trying for a commercial license. W5GQ reports working the west coast regularly. W5QJ is very busy these days installing broadcast equipment at WCCO. W5AWP says phone doesn't seem to get through the heavy summer QRN and he has ordered a 50-watt WE tube. W5AAP is still working foreigners, and has been QSO all U. S. districts. W5BEV has a MOPA now and says the messages have been coming through in good style. W5BBX blew his 7½-watt and borrowed a UV-202 from W5BHX. He is getting two 216-B rectifying tubes so as to get away from that AC note. W5BHX will be on the air as soon as he receives the stopping condensers that he ordered from Chicago 21 days ago. (Some service, eh?) We have a new amateur at Carlon, Miss., and we hope to have him going fine soon. Welcome, OM. W5AKP has plenty of QRM from business but he will be heard regularly before long.

Traffic: W5BBX 11, W5AWP 3. LOUISIANA — SCM, M. M. Hill, W5EB — Summer conditions have cut down activity in this section almost to a minimum. Several of the fellows are rebuilding for next winter. W5AD has a 75-watt xtal on 7000 kc. W5BDJ has just completed a 1929 screen-grid receiver. W5BAY has moved to Bastrop for the summer and has a 210 on 7000 kc. W5AXS is having trouble with his crystal outfit. He is going after a commercial ticket this month. W5ANA has moved to 14,000 kc. for life unless 56 mc. or 28 mc. gets better. Joy rides and swimming parties take up all of W5BDY's time. W5PG turned sailor and shipped out for a couple of trips this summer. W5WF says lack of time keeps him out of the BPL. W5EB has just completed a shielded

stal outfit for 14.7 and 3.5 mc. W5WG has returned from Penna. with an OW but has a 210 on 14,000 kc. in spite of her.

Traffic: W5WF 43.

HUDSON DIVISION

NEW YORK CITY AND LONG ISLAND — Acting SCAM, V. T. Kenney, W2BGO — Manhattan: W2BCB and W2BDJ are tied for first with a very low total in their boro. Both complain of power leak QRM; W2BNL has his outfit going at his new QRA. W2OV and W2AOY report. Ex-W1BYV reports that he and his roommate, W3CFG, will be going strong in our section in the near future. Welcome and good luck. Bronx: W2CYX is still keeping his sked with Europe and sends in a good total. W2AET is out of the hospital now and is rebuilding. W2AII has changed over from a 201A to a 210 and promises some real traffic work. W2ABS complains of the heat. W2AFT has changed to a MOPA outfit. W2BBX is in a new QRA with a 50-watter. Brooklyn: W2BJV has a sked with NJ2PA and is moving traffic. W2CCD is a new ORS. Long Island: W2AVP is operated by W2AEC, while AVP and CCD are at sea and leads the section in traffic. W2ASS has rebuilt and is QSO foreigners regularly on 20. W2ATT is a very busy man these days. He is installing W2AYM for his Boy Scout troop and can also be heard from his portable W2BFC. W2TV is still going strong.

Traffic: Manhattan: W2BDJ 8, W2BCB 8, W2BNL 4, W2BGO 1. Bronx: W2CYX 45, W2BBX 14, W2AET 12, W2AII 7, W2ABS 5, W2AFT 2. Brooklyn: W2BJV 70, W2BRB 23, W2PFF 19. Long Island: W2AVP 79, W2ASS 22, W2TV 11, W2ATT 5.

EASTERN NEW YORK — SCM, F. M. Holbrook, W2CNS — The gang is mostly off on vacations. Only four reports received. W2QU is building superhet and made RPL by scheduled traffic with nn1NIC. W2LU handled good traffic in Northern end of section. W2ALI finds autos and YLs cut down traffic considerably. W2BKV worked EG5GP. Some reports may not have reached the SCM this month as he was off on vacation. Hi.

Traffic: W2QU 195, W2LU 23, W2ALI 8, W2BKN 2.

NORTHERN NEW JERSEY — SCM, A. G. Wester, W2WR — Again we find a very lean report from the ORS and failure of the same ones to report. August will find some ORS being cancelled, as there are some stations who have not reported for four months. W2JF has been kept busy with skeds with W1MK and WSQ at sea. He would like some early morning skeds on 7000 kc. W2AOS was Acting Corps Area NCS for July and handled some traffic with W2CXL. W2DX is now WSQD at Detroit and wants skeds with this district. W2BDF is still QRL with WAAM. W2CJX blames his inactivity on the fine weather and sunburns. Hi. W2AOP completely wrecked his new flivver trying to move a tree at 45 per. W2AOY, an ORS from NYC, is vacationing in Allenhurst and has installed a 210 with 300 volts B battery under the call W2BDD.

Traffic: W2JF 33, W2AOS 31, W2JIC 10, W2BDF 7, W2CJX 18, W2AOP 3.

MIDWEST DIVISION

NEBRASKA — SCM, C. B. Diehl, W9BYG — W9QY is very busy harvesting, so radio gets a rest. W9DVR has the usual summer company QRM. W9FAM is on again, but has no schedules at his new location. W9DI rebuilt his receiver and is building a monitor between licks. W9CHB is away at school studying for commercial license. W9BBS is very busy, and by this time should be a conductor. W9BQR, W9EFW and W9FJI are very busy. W9BYG let his license expire and had to go before the R. I. for renewal.

Traffic: W9DVR 7, W9FAM 6, W9DI 3, W9BBS 4.

KANSAS — SCM, J. H. Amis, W9CET — Kansas has again broken all records for traffic. FB, gang. W9GHI is a close second and is using CW on 7000 kc. for the summer. W9FLG our congenial RM is rebuilding his xmitter. W9COE reports for the first time, and would like skeds in all directions. W9CJK is also a newcomer and is on 7000 kc. W9BTG is having a lot of trouble blowing condensers and 210s. W9CET is busy getting his National Guard communication platoon ready to go to camp in August. W9BHR

says the op at CX7, in a fit of Demonic fury, reduced his set to small pieces. W9GFO is also blowing things, including three blocking condensers. W9DEB is going strong again. W9SS has been on a motor trip and stopped to see the SCM. W9CFN is working in the harvest fields. W9HL enjoyed a visit from W8CXW and W8DCE. W9BLQ reports for the first time, and wants an ORS. The following ORS appointments have been made. W9DEB and W9GHI. All stations in this section are on 7000 and 14,000 kc. which accounts for traffic holding up during the summer months. Keep the good work up, gang. Don't forget the Kansas Convention at Topeka, September 13-14. Your SCM hopes to see all of you there.

Traffic: W9GHI 1082, W9FLG 608, W9COE 423, W9CJK 119, W9BTG 81, W9CET 63, W9BLQ 52, W9BHR 49, W9GFO 40, W9DEB 21, W9SS 15, W9HL 10.

IOWA — SCM, H. W. Kerr, W9DZW — Our congratulations to Kansas on their lead last month, and to W9EHN and W9ELW, who were married at Grand Rapids, Mich., July 15th. We regret that Iowa loses both these ORS whose future home is Grand Rapids. W9BCA leads, and his nnCAB sked never fails. He is to have a parrot from the CAB operator when he comes up on a vacation soon. The Tri-State Club was entertained aboard W9DHG's cruiser at Crystal Lake, July 10th. W9DRA is now at a BC station at Milford, Kans. Several ORS applications have been received. Let's have more! The SCM visited the Clarinda, Shenandoah and Malvern hams July 2nd. W9DEA goes to Great Lakes for his 2nd U. S. N. R. cruise in August. W9FDL received a new bug for his birthday. W9DWU puts LeMars on traffic map. W9AWY is a new ham at Des Moines. W9DXP is still rebuilding. W9APM is on 7145 kc. week-ends. W9GDR copied KHEJ first day out. W9DOA is revamping his transmitter for fall work. W9BJJ is still at WLBW. W9DNZ was reported first 3500-ke. station logged at South Road P. O. St. Marys, South Australia. W9DDX using 201A wants traffic. The "diamond" club is still active in Iowa. W9ETV is getting ready for traffic. Let's have more reports next month, fellows.

Traffic: W9BCA 62, W9FZO 41, W9DWU 23, W9DXP 21, W9DZW 14, W9FDL 6, W9FFD 5, W9DVS 4, W9CDD 2.

MISSOURI — SCM, L. B. Laizure, W9RR — W9DOE is spending the summer in Duluth. W9DZN seems to be the leading traffic man in St. Louis since the summer season got in a few whacks on the gang. W9EDK has been away from home too much for operating. Someone sent in a report of five messages from St. Louis, but omitted to sign the same. W9BZM sends 73 to the gang, and says he's not as dead as some others we might name. W9EPX applied for U. S. N. R. and is also QBS, OQ and in the A-A net. W9DHN is resting from traffic this season, but is coming back on 3500 kc. for fall. W9GCL put up a new tower and rebuilt the works for more power. W9FVM handled a few messages. W9BJA is trying to work out a plan to assist the NAT and Yellow Cab airlines to collect weather reports by radio. W9ECS is a WU operator now. He has gone to Larned, Kans., for his first assignment, and hopes to be back in Missouri soon. W9GBT has been on 14,000 kc. this month. He asks the hams to drop in on him when going through on U. S. 50. W9CJB sends in a blanket report for the gang at Festus with photo of his station. FB, OM, W9FAL and W9EYB are very busy trying to get the wherewithal to boost their transmitters up another peg. W9GJF has completed his new layout using 210 on 7000 kc. W9GAW sends his first report in this month, reporting about \$75 loss from lightning. W9CDU is a new station in Nevada, and applied for ORS.

The SCM has been doing some rebuilding and remodeling, and hopes to be able to QSO by radio before another report is due. W9CFL has been appointed Unit Commander of the K. C. U. S. N. R. unit. W9DQN has been comparing low power 14,000-ke. operation against a 50-watter on the QRM band. W9BSB is suffering from the heat and YL QRM. W9FYP gave the SCM a boost with news of the doings of W9EYP, W9AHZ, W9DLL and W9ZD with low power tones. Cross town chinning is the order of the day with these sets. W9ALC is going on 7000 kc. with a 210, and wants to handle all traffic possible. W9ACX took the exam for U. S. N. R.

Traffic: W9DZN 10, W9FVM 6.

NEW ENGLAND DIVISION

CONNECTICUT — SCM, C. A. Weidenhammer, W1ZL — This report finds the SCM enjoying a trip through Pennsylvania. WIAMC is in New York. WIBGC left for Montreal recently. He quaintly termed it "America's Filling Station." Hi. WIBWM promises a surprise shortly. We are anxious to know what it is. W1RIQ passed his amateur exam and rebuilt his station. FBI W1TD built a monitor and erected a 3.5-mc. Zeppelin antenna. WIAMQ of Milford, an ORS prospect, is coming along nicely. WIAMG also proved to the R. I. that he knew his "ham" radio. He handled traffic with KFLF. W1AFB worked a lot of DX on 14 mc. with his CX310. W1CTI reports a visit from W1CQ of New Bedford. W1VB gets better signal reports in his new location. The old attic shack is too hot for operation at W1BNS these days. W1MK manages to survive the heat. Contact on 14 mc. is splendid at W1BJK. W1CKP will be inactive until Labor Day. W1RP gets on when *les femmes* permit him to. W1BOD states that 14-mc. traffic is usually more important in content at his station than 3.5-mc. traffic. W1BI-BQJ had fair luck with the portable in the White Mountains. W1APF is sailing under the Honduran flag and operates a British installation. W1AJB reported for the first time. W1ARL has started on the air in Danbury. W1VE enjoys his Ward Line job more every day. W1CPO received a report from the Canal Zone. W1ACB is out for an ORS appointment. W1ZL will be in Pennsylvania until October. Send reports as usual to his home address. The SCM asks W1BOD's pardon for listing his April total as 6 instead of 16 messages. Sorry, OM. W1BWM has a new 8½-lb. xmitter kicking out QSA5 — born July 19th. FB

Traffic: W1BOD 6, W1RP 40, W1CKP 52, W1BJK 8, W1MK 39, W1BNS 2, W1VB 1, W1CTI 1, W1AFB 16, W1AMG 17, W1AMQ 44, W1BLQ 7, W1BGC 6, W1AMC 11, W1ZL 2, W1AJB 21.

EASTERN MASSACHUSETTS — Acting SCM, E. R. Sharp. W1ACH — Well, gang, we are very sorry to lose our SCM, but we are glad that HQ is to be the gainer by the addition of W1UE as Assistant Communications Manager. We sure wish Ev all the success in the world. Let's carry on and show him some good traffic totals next month. W1WU reports that he is skedding with the YL for life. Hi. Good luck, OM, and hope you make an op out of the OW. W1KH is keeping a very worthwhile sked with V08AE, and wants to know what has become of the early 7:00 a.m. gang for skeds. W1WV finds DX poor and has turned to a new Atwater Kent broadcast set for consolation; he also has a sked with V08AE. W1LM is still trying to coax W1ACH to listen for him once in a while. Keep up your courage, FM. W1BVL reports good DX on 14,000 kc. W1RL has bought a new car and hence traffic has taken a slump. W1KY entertained a visiting 8th district ham and his family. W1KY, W1ASI and W1LQ sent in good totals and W1LQ was QSO a Dutch boat off Bermuda on 3500 kc. FB. W1ACA has a portable with him on his vacation. W1AAW has got a commercial ticket. W1BBT is off the air until fall. W1RY worked WDDE and handled some traffic. W1AGP has been experimenting with various arrangements. W1AOT has a new antenna. Don't forget to report, gang, even if there is not much station activity. Some ORS are very lax in this respect.

Traffic: W1LQ 72, W1ASI 34, W1KY 33, W1ACH 28, W1KH 26, W1RY 21, W1WV 20, W1BLD 18, W1WU 17, W1LM 12, W1AAW 2, W1AOT 2.

WESTERN MASSACHUSETTS — SCM, J. A. Tessmer, W1UM — W1NS has three transmitters on the air, but only one at a time on 14,000, 7000 and 3500 kc. We are sorry to hear W1BZJ is sick. W1BNL, who is one of the operators at WTAG, says he took 25 messages from W3FC and has a schedule every night now. W1BSN worked P. I. and Australia. W1CGR working on 3500 kc. with crystal. Beoder has schedule with Ryrd. W1BSJ is making a new xmitter and receiver. W1AMZ is visiting at Everett, Washington. W1AKZ has a rectifier with "creepits." W1EO is moving. W1BVR is still on 7210 kc. W1UM is having his transmitter overhauled. W1BKQ has open house Thursday evenings. W1ADU is reconstructing everything from antenna down to 110 v. A. C. line and is even putting in an

xial. W1OF and W1AWW just got back from a one-thousand-mile trip with portable up through New Hampshire and Maine. They worked many stations in eastern U. S.

Traffic: W1NS 31, W1BNI 37, W1AMZ 14, W1AKZ 3, W1BVR 3, W1ADO 2, W1OF 2, W1AWW 2.

MAINE — SCM, G. C. Brown. W1AQL — The Queen City Club and members of Unit No. 6 of the U. S. N. R. were entertained in a very fine manner by Unit No. 8 of Belfast on July 14th. Lt.-Commander Lee and several Naval officers from Florida dropped in for a short visit, and Director Best was also present. Much credit is due Lt. H. B. Morris and his men for the excellent reception. The convention program is progressing in a fine manner, and it is hoped that this will be one of the best Maine get-togethers on record. Traffic took a slump this month, due no doubt to warm weather, vacations and QRN. This is an ideal time to give the old shack the once over and get prepared for the fall rush. W1ATO is high liner this month. W1ANH is a close second. He reports that summer school at Harvard will cause his station to be inactive until October 1st. Mrs. W1AJC leads the OM again this month. They report visits from W2APS and W2AJP. W1TB reports a fine trip to Boston. While there he visited W1LQ, W1ACH, W1WV and W1UE. W1AHY reports no traffic this month, due to vacation. W1ACV is traveling for the Western Electric Co. W1BFZ, W1QH and W1BX recently enjoyed a trip down through Canada. W1KQ has recently been appointed as an Official Relay Station. We have a newcomer again this month in the person of W1CCN. FB. W1CDX reports the weather as very poor for traffic up in his neck of the woods. He says that W1CB, W1AKY, W2AJP and W2APS were recent visitors. W1COV reports that he is ready to do business on both 7000 and 3500 kc.

Traffic: W1ATO 78, W1ANH 75, W1AJC 36, W1COV 35, W1CDX 33, W1QH 28, W1AQL 24, W1AJC 20, W1TB 11, W1KQ 10, W1CCN 6, W1BFZ 5.

NEW HAMPSHIRE — SCM, V. W. Hodge. W1ATJ — Rebuilding and nice wx kept most of the stations off the air this month. W1BFT is building a power panel for his 852. Bob Ballard has been on a 15-day Naval Reserve training period. W1AUJ has been busy keeping the BCL's troubles fixed. W1IP is doing some work on 14,000 kc. W1AUE worked some DX on 7000. W1AVJ is trying his 852 on 14,000. W1CDT of Meredith has been appointed an ORS. W1CEQ, who was at N. H. U., has been at R. O. T. C. camp in Virginia. He and W1BK plan to have a real outfit at Durham this fall. W1APK hasn't been able to be on much due to other work. W1AOV and W1BFT are making a tour of N. H. stations.

Traffic: W1APK 1, W1AUJ 1, W1BK 36.

NORTHWESTERN DIVISION

OREGON — SCM, W. S. Claypool, W7UN — This month shows very little activity if reports mean anything. W7MV, the RM, sent out over twenty cards with return postage, but failed to get any support in organization. If this continues, there will be many ORS without certificates. W7WB suggests that we name W7PP "The Vagabond Lover." Ask W7AMQ about particulars. W7IF reports and says push-pull FB. W7PL says QRL with farming. W7PE is getting ready to show the boys how to enjoy the Northwestern Division Convention in Portland. W7AMF, W7WL and W7ALK reported between convention work, experimenting with push-pull and presiding at RDO Club. The SCM finds a few spare moments. W7FH is getting started in Army Net. FB, OM. W7ALM says walking contests are NG. Hi. W7LT, W7WH and W7LP are spending vacations at nearby beaches. W7AMQ was listed as W7ANQ in the BPL in July QST. It won't happen again, OM. Let's show the folks we can handle traffic, gang, so everyone get some good skeds and be sure to report.

Traffic: W7PL 48, W7PE 39, W7WM 36, W7UN 37, W7AMF 30, W7WL 24, W7ALM 26, W7ALK 14, W7IF 10.

WASHINGTON — SCM, Otto Johnson, W7FD — W7PH in Everett steps up and takes the prize this month for traffic handled. W7ACY worked XW7EFF 12,500 miles away. W7MW, W7PH, W7ACY and W7NR use 3530-kc. fones. W7RW is a newcomer. W7AAB and W7FK have new SG receivers. Tacoma is still on the job, although W7AFO was the only station reporting. He reports that he is the

proud possessor of a WAC certificate. W7GP in Olympia reports a rough trip on the capital to capital race between Olympia and Juneau, Alaska. Some traffic was handled. Several newcomers have moved to the "Charmed Land." W9EQR from North Dakota will locate in Seattle. W6EGR is pounding brass at W7OV till he gets located. W7AON-W7GE has moved from Portland to Spokane. Let's hope he peeps up the boys back there a little. In Seattle we find much activity. W7TX still runs schedules with a number of Alaskan 7s. W7AG is on fairly regularly. W7LZ is recovering from the strain of becoming a father, and will be on regularly. W7KO shows the boys how it's done with 110 messages, all originated and delivered. W7BB is on WMC1 enroute to Hawaii. W7AEV is op at KXA (BC). The gang are going to take in the convention at Portland en masse from all indications. Let's hope Mrs. W7FD will not be the only feminine guest at the banquet this time. Bring along the OW or YL, fellows. See you all at Portland, August 30th and 31st.

Traffic: W7PH 157, W7KO 110, W7BB 97, W7MW 85, W7TX 70, W7AEV 47, W7GP 33, W7AG 20, W7ACY 10, W7AFO 9, W7FA 8.

ALASKA — SCM, W. B. Wilson, W7WDN — This report by radio via W7FD — K7HL reports through W7TX as usual. This combination is sure a dandy for moving traffic. K7HL blew his 852. Tough luck, OB. Let's hear more from the Alaska gang.

Traffic: K7HL 77.

MONTANA — SCM, O. W. Viers, W7AAT-QT — The SCM has been having quite a siege of sickness and has found it necessary to give up his W. U. job and return home for a while. Sorry, OM, and hope you get your strength back soon! W7AAW manages to push a few through. W7DD says QRN makes it very hard to copy all signals. He has a new ham coming along in Anaconda. The gang is very lax about reporting and the SCM asks that the "Montana boys snap into action at once."

Traffic: W7AAW 21, W7DD 14.

PACIFIC DIVISION

HAWAII — Acting SCM, Ray B. Rietow, K6NL — Our SCM has deserted the ham ranks temporarily for a position on the U. S. S. *Guide* which will keep him at sea for three or four months. From all indications there are going to be several new stations on the air in the future, two of which will have commercial ops who are breaking into the ham game. K6DU took the lead this month in traffic handling with a total of 301. He has regular skeds with W6SF, W6EQF, W6ASH and W6EOS. K6DWS in Maui on 7050 kc. wants to know what the matter is with the HU stations, as he has lots of trouble getting his traffic over. K6DTG has two ops now, so should keep things buzzing. K6DCU has left to enter West Point. FB, K6ACW reports working KFR5. W6AVZ is home visiting his mother after an absence of nine years.

Traffic: K6DU 301, K6DWS 231, K6AVL 120, K6DTG 76, K6DCU 44, K6EST 39, K6ACW 16, K6ETF 16.

LOS ANGELES — SCM, D. C. Wallace, W6AM — W6EQF, W6CBW, W6ETJ, W6CHA, W6AHP and W6AKW make the BPL this month. W6AKW is now U. S. A. base station for P1Z traffic. W6CBW reports R8 from Java. Philippine or China traffic can be routed through W6EQF, as he has daily skeds with K1CM and ACRV. W6AHP has been keeping a sked with the Boy Scout Camp in the mountains, and radio is their only means of communication. W6ETJ has new Zepp antenna and transmitter now perking FB. He worked a few VK's and ZL's. W6ETJ is one of our new ORS and he makes the BPL. W6DKV has been experimenting with ultra short waves below 5 meters. W6AKD bought some copper tubing to make some coils for a new transmitter, and received a call from two policemen, who tore the door off his shack looking for a still. W6DHM says if he is not swimming he is pounding brass. W6CHA is keeping some fine skeds. W6ESA handled some Elks Convention traffic, and is changing from chemical rectifier to Mercury Vapor Rectobulbs. W6BZR has been getting his material ready for entry in the A. R. R. C. Cup contest. W6CUH reports plenty of traffic on 7 mc. He worked seven countries on 7025 kc. one morning. W6EKC reports that W6CUA is in Bakerfield for a few weeks, and is pounding brass at

W6EKC. W6QL worked all continents in 18 hours on 14 kc. with 210 tube. W6ALR has been helping hams get started. W6ETC is rebuilding. W6DLN camped out at Palos Verdes hills with his portable. W6CLR, W6CUH and W6ACL were along. They worked KIPW with 7 watts input. W6AM has put in a new smoother keying system in 6-phase plate supply. W6ASS, W6ELZ, W6EKE, W6CHW and W6EPN send in good reports. W6EVA (YL) is starting on a trip to Vancouver with W6ETA (also YL), and will try to visit all hams they have QSO'd. W6UJ reports vacation wrecked skeds, and traffic fell off badly. W6DHS and W6BKK of El Monte got commercial licenses OK. W6DYL and W6ELY of Monrovia and W6UJ are still working on portable transmitters and receivers. W6BFI builds dynamic speakers. W6DSG QSO'd Europe. W6BRO has been ill, but sends in a good total just the same. W6AGR, W6DLI, W6ZZD, W6DZK and W6ABK report as usual. W6ANN reports QRM from Cal. Tech YLs. W6HT has been elected Assistant Route Manager for the Long Beach District. W6AWY has been very QRL during the summer months. W6DZI cut down his sked for a few weeks. W6AXE was QSO with WSBS. He is now secretary of the Pasadena Short Wave Club. W6BIX, RM, reports the appointment of two new Assistant Route Managers, W6QL and W6HT. James M. Chapple, Radio Inspector, is a member of the Short Wave Club of Pasadena. W6BSL reports that the station will be active with four operators when college starts. W6DPY is working CW on 7000 kc. and fone on 3500 kc. now. W6EQV sends in his first report. W6HS has finished his new receiver and will be on week-ends. W6AEC is going to work nights now, so will have time for some day skeds. W6COT is kept pretty busy with both school and work during the summer. W6EJ just returned from San Francisco where he saw several hams. W6DYJ is laying for South Africa. W6ZZA reports that 22½ portable Ray-O-Vac lasted 1½ years in W6ZZA. W6MA has been playing on 14,000 kc., but spark plug QRM bad. W6DUJ is on the air regularly. W6EIO is moving his station. W6AWZ just moved down from Oakland and will be on the air soon. W6DIJ is spending the month on vacation and finds it is hard on his traffic total. W6ZBJ still is in camp trying to keep the boys from biting the rattlesnakes. W6EAF spends his time trying to QSO Army Amateurs. W6DLO visited him.

The Pacific Division Convention will be at Los Angeles, and the dates are November 29th and 30th. Headquarters Alexandria Hotel, L. A.

The Hollywood gang put on a hamfest June 15th, and about 100 attended. The Associated Radio Amateurs attended the meeting of the Short Wave Club of Pasadena on July 19th and had a very enjoyable time. W7MY visited the ARA meeting July 12th and operated some Long Beach stations. W6BQ, former SCM of San Diego, has moved to Los Angeles. W6ENB from Mission Beach visited ARA July 12.

Traffic: W6AKW 382, W6CBW 210, W6EQF 205, W6AHP 192, W6ETJ 170, W6DKV 148, W6AKD 126, W6DHM 50, W6CHA 228, W6ESA 48, W6BZR 35, W6CUH 34, W6EKC 31, W6QL 27, W6ALR 26, W6ETC 25, W6DLN 21, W6AM 16, W6ELZ 16, W6EKE 16, W6EVA 15, W6UJ 14, W6BFI 13, W6DSG 12, W6CHW 12, W6BRO 10, W6AGR 10, W6ABK 10, W6ANN 10, W6EPN 9, W6HT 9, W6DLI 9, W6AWY 8, W6DZI 8, W6AXE 6, W6ASS 6, W6BIX 5, W6BSL 4, W6DPY 4, W6EQV 3, W6HS 3, W6AEC 3, W6COT 2, W6EJ 1, W6ZZD 1, W6DYJ 1, W6ZZA 1, W6MA 1.

EAST BAY — SCM, J. Walter Frates, W6CZR — Traffic took another rise this month, due to the very FB work of Houston and De Geus in operating W6SR-AV3 at the National Guard encampment at San Luis Obispo. They kept the Guardsmen in camp in touch with their relatives at home. W6ASH made a very fine record through skeds with the camp and other stations. W6ALX, the section's leading operator, ran up another high total through skeds with the camp. W6EIB came in with the leaders, maintaining his usual fine schedules. W6IP, the CRM, ran up a high total in spite of arranging Naval Reserve skeds, routes for beginners, and writing the voluminous correspondence which goes with his work. W6AWF, a new ORS in the section, did himself proud this month. He has been relaying messages for WFA in the South Pole. W6CGM reports contact with P. I. fair.

He is keeping a sked with K1PW. W6HJ turned in his last report before closing his station at Vallejo and moving to the San Francisco section. We are very sorry to lose him as he has been a very consistent amateur and ORS. W6CTX in Berkeley has been doing a great deal of experimenting as well as some traffic work. He is a scoutmaster in the Boy Scouts, and is working on a cross country net of Scout amateur stations as part of the Scout move to interest the younger fellows in amateur radio. W6EMI says he has been kept very busy studying for his commercial ticket. W6BMS announces that he added one mike more to his filter and got 50% more out-put and 50% worse vote. Hi. W6EDR, his buddy, says that W6BMS has not been on the air much because he has stolen W6EDR's YL. W6ATT has also been working WFA in the South Pole. W6EJA is moving along in fine shape. He has a UX210 in a Hartley with about 550 volts on the old saucer. W6RJ had to give up his old standby, 3500 kc., because of a power leak and is going to open up on 7000 and 14,000 kc. with a low-power MOPA. W6BZU, the Pride of Concord, refuses to let the summer months keep him from hammering his old xmitter. W6BFO is building a new receiver and is putting up an antenna with a reflector. Hope he doesn't take the reflector off W6DCZ's Ford. W6ASJ has just returned from Napa, where he put in an ice plant and has gone to Salinas to repeat the performance. He expects to be on the air from Salinas under his portable call of W6CRE. W6GQ has been working K6ZZE, old W6AAU, at Loring, Alaska. His son, W6CFD, has just opened up on 3500 kc. with a low-powered job. W6CZR-W6ARU are both off the air.

Traffic: W6ASH 512, W6SR 450, W6ALX 430, W6EIB 234, W6IP 211, W6AWF 106, W6CGM 86, W6HJ 64, W6CTX 58, W6EMI 23, W6BMS 19, W6ATT 11, W6EJA 5, W6RJ 6, W6BZU 4, W6BFO 4, W6EDR 3.

SANTA CLARA VALLEY — SCM, F. J. Quement, W6NX — W6BVY proved the mainstay in trans-Pacific communication during the past month, ably filling in the vacancy occasioned by W6BYY's layoff due to pressure of business. K1AU and K6DTG handled their end in good shape. In last month's report, it was mentioned that W6BYY had joined the Signal Corps of the U. S. Army. This was erroneous and should have stated that W6BYY had signified his intentions of joining the U. S. N. R. Communication Branch. W6JU has cancelled all skeds for the summer. W6BMW is putting in an 852 for 14,000-ke. work and is also rebuilding transmitter for 3750-ke. U. S. N. R. drill communication. The ops at W6AME were favored by a visit from the YLs, W6ETA and W6EVA. W6BAX was QSO five continents in 3½ hours in addition to a nice QSO with WFAT. W6NX drills twice weekly in the U. S. N. R. radio net on 3750 kc.

Traffic: W6BVY 382, W6BYY 125, W6JU 53, W6BMW 15, W6AME 20, W6NX 12, W6BAX 6.

SAN FRANCISCO — SCM, C. F. Bane, W6WB — Eighteen stations report again this month. FB, fellows. W6ERK leads the section, making the BPL both ways. He is getting to be known as the "sleepless wonder." W6AD, our old star, has been rebuilding and will be back again real soon. W9EPT sends in a fine report. W6AYC perks up this month and sends in a good total. W6DZZ has been getting nice results with his new MO-PA. He edged out W6BIP in traffic this month, so it must be FB. W6BIP and W6DYB dropped down this month on account of vacation, as did a number of the boys. W6PW has evidently decided to show the gang that he can bat out the traffic, as he hands in nice total this month. I'm mighty sorry to see that W6WN, our RM, has found that the amplifier business takes up too much time to devote any to the RM job. Mr. Kellogg, W6DBD, is his successor, and reports a good total this month. W6CIS reports traffic better. I wonder if W6DPF is an ORS, or if I just dreamed it? W6EEH has been rebuilding. W6DFR is having fine success as Army-Amateur net control station and reports regularly. W6DMS sends in very fine total for his first time up. W6KJ brightens up this month with much better total than usual. W6DSS is now ORS. W6EEG says the Colpitts circuit is the best ever, and the new set is stepping out in fine shape. W6DZQ says he is getting grey hair trying to make his Ultraudion perk. W6WN reports. W6WB is using MO-PA and expects to have xtal going before very long. W6FK also has his eye on

xtal. We are glad to see W6HJ back in the section, and sure hope he reports regularly. Let's go, you old-timers. The new boys are certainly showing you how it should be done. What has happened to the gang at W6BL? I shall be very glad to hear from any new stations in the northern part of the section.

Traffic: W6ERK 437, W6EPT 165, W6AYC 104, W6DZZ 82, W6BIP 62, W6PW 48, W6DBD 45, W6CIS 42, W6EEH 30, W6DFR 26, W6DMS 25, W6KJ 14, W6DYB 8, W6WB 6, W6DSS 4, W6EEG 2, W6DZQ 1.

SAN DIEGO — Acting SCM, H. A. Ambler, W6EOP — W6ACJ again leads the section in traffic. W6EOS, our new ORS, has a nice total and is working lots of DX. W6EOP holds sked with K6DTG twice a week and will be glad to get your Hawaii traffic. W6EPZ is back on the air with QRO and is getting more skeds lined up. W6DGW is on 14 mc. W6EPF was very QRL vacation and cancelled all skeds for two weeks. W6EOM is very QRL putting hams over the meat counter. Hi. W6BAM is on the 14-mc. band now. Several of the ORS failed to report this time. Come on, fellows, let's have your reports.

Traffic: W6ACJ 74, W6EOS 70, W6EOP 67, W6EPZ 56, W6DGW 21, W6EPF 18, W6EOM 17, W6BAM 1.

SACRAMENTO VALLEY — SCM, Everett Davies, W6DON — Once again W6EEO makes the BPL with over two hundred deliveries. With a total of over three hundred messages, he says: "The reason for the bad slump is that I was off the air for fourteen days this month, due to blowing three fifty watters." There is a ham for you! W6EEO keeps daily skeds with AC8RV and K1HR. Miss W6ETA has been spending her vacation with Miss W6EVA. She sends in her report from the S. S. *Harvard*, going to Portland, Ore. W6AFU makes the BPL with deliveries from the National Guard Camp. W6EOU worked Byrd and LCFH. W6ER has a portable call, W6CQE. W6BDX has a new Ford. W6AIM got his ORS. W6EEN is having lots of fun with his new "printer" on the ABC net at KFBK. W6BSN has a R8 card from Japan. W6DON was able to handle a little traffic with LCFH, and is now trying to make an inductively coupled MOPA work. The Sacramento Valley Amateur Radio Club wants the 1930 Pacific Convention.

Traffic: W6EEO 335, W6AFU 112, W6DON 63, W6ETA 42, W6EOU 33, W6BDX 20, W6AIM 8.

PHILIPPINES — SCM, M. I. Felizardo, K1AU — This report was sent in by KICY — On June 2nd, K1AB, K1AC, three ops from K1BD, K1DL, K1EL, K1GZ, three ops from K1HR, K1XA, K1XR and K1ZC were the guests of John R. Schultz, K1JR, at a ham fest. They all reported a wonderful time, and think K1JR a fine host. K1MC is now crystal calibrated with monitor, and will give checks on frequency whenever requested. FB. K7OE has returned from the States with a MG and parts for a 50-watter. K1AF is using remote control. K1HC, an old 1911 spark man, is back on the air. K1CM is handling most of Fort Mills traffic. K1HR reports by radio via W6EEO with very large total. FB. He is keeping same schedules as were in August QST report. DX weather has been poor but the traffic men have been pounding away FB — keep it up, fellows! AC8RV, Shanghai, also reported via W6EEO and is doing some nice work.

Traffic: K1HR 533, AC8RV 137, K1AF 191.

ROCKY MOUNTAIN DIVISION

COLORADO — SCM, C. R. Stedman, W9CAA — W9DQD finally got his rig going and started out the month with a nice traffic total. W9EAM has been too busy selling gas to Ford owners to do much radio work. W9CSR has been vacationing. W9CAA has been off most of the month being rebuilt to a considerable extent. W9CDE is on 14,000 and 7000 kc. W9FEM is trying to burn up the ether with a bug. W9CLD says it's so hot he keeps the stove burning to cool the air off. W9DXW, W9CAA's station in the mountains, has been on week ends. W9BQO had a couple of rectobulbs fall apart, and he is waiting for the promised replacements to reach Denver. W9CHK will be on the air soon as he gets hold of a power transformer. W9GGW got his mercury arc working OK. W9CVF sends in a report. Let's have more, OM. W9DQV reported by radio. Some one made W9CWX a present of a 250-watter. Who says there isn't any Santa Claus? W9EGT has left the state, but he

did a little work at the last minute. W9FXW is working out in fine shape with his Ford coil CW. W9EDM has been having a lot of grief with his set. W9TX, a supposedly dead one, says he is about ready to go again. FB. W9BDY has left the state and is now oping a BC station at Billings. W9EBF says he is having a lot of trouble moving his traffic. The annual convention of the Rocky Mt. Division will be held in Denver September 6th and 7th, and the Denver gang extend a cordial invitation to all hams to attend. We assure you of a pleasant time that will be well worth your while. The SCM will be glad to answer any inquiries.

Traffic: W9CAA 5, W9CDE 5, W9DXW 2, W9EGT 4, W9EBF 4, W9DQV 11, W9CWX 16, W9CVE 78.

UTAH-WYOMING — SCM, P. N. James, W6BAJ — W6DPJ is the star station this month, handling more traffic than the rest of the section put together. It only takes a few minutes a day to keep a few reliable skeds, fellows. W6DPO is working 12 to 14 hours a day, but managed to push a little traffic through. W6EKF left for the northwest, so we will not hear from him for a month or so. W6RAJ had a hard time clearing up a few messages on 7000 kc. W6CNX is working hard for his WAC. In two weeks he worked 20 countries, including England, on 14,000 kc. W6DXM has also been working DX on 14,000 kc.

Traffic: W6DPJ 98, W6DPO 20, W6EKF 19, W6BAJ 14, W6CNX 10, W6DXM 5.

ROANOKE DIVISION

WEST VIRGINIA — SCM, F. D. Reynolds, W8VZ — Things took a turn for the better this month.

Through the courtesy of W8ACZ, a hamfest was held at his station on July 15th. W8CLQ, W8CNZ (Pittsburgh), W8ALG, W8BCN, W8AKT, W8JM, W8ACZ, W8VZ, W8BPU, W8CCN, W8BDP and W8CSR were present. W8BCN and W8JM helped with the program. Several of the bunch argued the DX question while others tried to make the transmitter operate on 7000 kc. We finally wound up with three transmitters for 14,000, 7000 and 3500 kc. The bunch visited the local stations and finished by inspecting the BC station, W8MMN. From there they went to a park to partake of some eats. This turned out to be an endurance contest, because there was more than enough food to go around. We think W8ALG gained several avoirdupois during this session. Hi. After the eats, everyone returned to W8ACZ's, from where the party broke up. Before they left, everyone agreed that we should hold another such get-together next month at Mannington. By the time this gets into print, we will be looking forward to a meeting at Shinnston, so I'll say see you at W8ALG's.

The gang in the southern part of the state seem to be slowing down a bit, except W8OK, who has his army skeds, and W8WK, who handles navy work. W8OK has a very businesslike-looking station. W8DNN dropped in the other day from Parkersburg and asked that we set aside his ORS appointment, due to inactivity. Hope you are back with us by fall, OM. We understand that W8DOH of Wheeling is married. Congrats, OM, and good luck. W8HD says he is on 3500, 7000 and 14,000 kc. now. W8BCN has been having tough luck with his tubes. Better get a drip-pan for your grid leak. Hi. W8CCN is looking for a big tube now that summer vacation is here. W8ALG is using a 210 and intends to enroll at WVU this fall for their radio course. W8CLQ and W8ALC are working Morse wire. W8ACZ is busy cleaning up his station after the hamfest, and promises more traffic for next month. W8JM borrowed W8BDP's transmitter, and has been doing pretty good. W8SV returned from California and started right to work. W8BDP intends to get a job in Pittsburgh. W8BPU and W8VZ report their frequency as 890 kc. from now on, as they have the xtal on the BC plant now. W8CSR is busy with the roofing business. Kinsner of W8VY ex W8SP was in town last week. The SCM extends his thanks to W8ACZ, W8BCN and W8JM for the fine get-together they put over. Good luck to everyone until next month.

Traffic: W8ALG 26, W8CLQ 79, W8BCN 21, W8JM 24, W8ACZ 56, W8VZ 4, W8HD 4, W8OK 18.

VIRGINIA — SCM, J. F. Wohlford, W3CA — W3EC is using the same transmitter; one 204-A with two 50-wattors for rectifiers. They are building a shielded short wave receiver now. This station has six operators. They work

remote control in connection with WUF and handle a lot of Army traffic when QRM is too heavy on long waves. The station holds an ORS certificate, and is on the air about fifteen hours per day. Following are the skeds at W3EC: W3SN, W3BWT, W1MK, W1TY, W3ARU. Skeds are wanted with fourth and ninth districts. Experimental station Do-1 (W3ARU) is doing fine work with planes on 7000 and 3500 kc., using one 50-watter in Hi-C Hartley. W3ARD is on once in a while, and says DX. FB. W3SZ and W3QE will combine their stations and be on the air this fall. W3MT is on when business and YL can spare the time. W3MO is hamming with the gang and has a fine DC note. W3PF has a 282 now, and is working some DX. W3CGF has returned from college. W3ALS is building a new receiver. W3BZ is on the air very little, due to heavy QRM from static and street cars.

Traffic: W3FC 382, W3ARU 27, W3ALS 42.

NORTH CAROLINA — W4TS and W4AB are tied for high place this month. W4AB is back on from school. W4OC says that FQPM brought him a parrot from Africa — he thinks he will name it "P.M." Hi. W4OC is keeping some time skeds. W4TN has been operating on 14,000 kc. to escape the QRM. W4UB has been helping W4AH get his set going. He says hot weather is responsible for low talk. W4AEW kept sked with W4KV. W4AKU worked NTT, which he thinks was somewhere off the coast of South America.

Traffic: W4TS 48, W4AB 48, W4TN 28, W4AEW 10, W4UB 9, W4OC 5.

SOUTHEASTERN DIVISION

ALABAMA — SCM, S. J. Bayne, W4AAQ — W4A1M and W4AX have about completed the 150-watt job to be installed at the Armory. W4AHZ is considerably under the weather. W4JY has completed a neat 100-watt outfit. W1WS works DX on 14 mc. with a 201A. It wiggles with 500 volts on the plate. The twins at W4LM will soon be ready for an ORS certificate. W4APH has been in N. Y. W4AIV is home for the summer and pounding away. W4RC attended CMTC in August. W4UV now reports a commercial ticket. W4AQ has closed down for the summer. W4AHQ is attending the Auburn Summer School. W4AKM has forsaken the Hartley for tuned plate-tuned grid. W4TI hasn't missed a single Army-Amateur schedule. W4IA and W4TI are partners at Bridge. W4AHP spent the entire month at CMTC. W4AJR has moved into a fine shack. W4AHR and W4AHP will spend their vacation together in Florida. W4AKB can't understand why his 210 blishes. W4MY finds DX fine on 14 mc. W4HB, makes his first report. W4AAQ spent six weeks in Florida and is back on the air. The SCM wishes to announce the following new stations: W4JQ, W4ALG, W4EW. We would like to hear from the following new stations: W4MB, W4AHY, W4ALG, W4EW, W4AID, W4AKY, W4PC, W4HP.

Traffic: W4AHR 29, W4TI 25, W4LM 22, W4AKB 14, W4AJR 12, W4UV 11, W4AAQ 9, W4AKM 7, W4WS 4, W4AHZ 4, W4HB 7.

FLORIDA — SCM, Harvey Chafin, W4AII — We regret the loss of W4KY, killed on June 13th at Nassau, Cuba, in one of the Pan-American airships. He was at the radio control when the plane fell to the ground. W4HY has a DC note on 7150 kc. W4ZP receives the highest traffic honors this month. W4QI, and W4NB are new stations in Miami. That radio club is sure making hams. Hi. W4AKF regrets the loss of his schedule with J. N. Griffin, W4KY, and says his silent key will never be forgotten. W4AKF has a new push pull Hartley for 14-mc. work and has schedules with NDD, W5OE and W4ZW. W4NE is in charge of the radio supply department of the Pan-American Airways of Miami. W4NZ, W4NE, W4PL, W4AAO, W4AY and W4ABA are also connected with P. A. A. W4AGY has a schedule with W4KV. W4AII is touring through Georgia and Florida on a fishing trip accompanied by C. Turlington and W4SY. Please send your reports in on the 16th of each month, fellows.

Traffic: W4ZP 43, W4AKF 16, W4NE 15, W4AGY 8, W4AII 7, W4HY 6, W4SY 5, W4PAW 3, W4UW 3, W4IG 3.

PORTO RICO-VIRGIN ISLANDS — SCM, E. W. Mayer, K4KD — K4KD has been elected SCM and makes

the first report for this new section. All stations are requested to report to him on the 16th of each month. Dope on schedules and traffic work are particularly desired. Applications for ORS, OBS and OO appointments are now in order so think it over, fellows. Volunteers for RM job are also needed. K4AAN reported via radio direct to Hartford. He is on 14,000 kc. W4AKV is active. K4KD is on 7000 kc. daily from 6 a. m. to 7 a. m. and working good DX.
Traffic: K4AAN 39, K4KD 5.

WEST GULF DIVISION

NORTHERN TEXAS — SCM, J. H. Robinson. W5BG — W5RJ reports for the first time with the biggest message total that has been in this office. We will print same herewith on account of its size: 108. He has had more than his share of tough luck by blowing four 250-watters, one 852, five 210s and six 281s. W5BAM shows up good this month. He is keeping skeds with W5RH and W5BFY. W5BAM is putting 1500 volts on each of two 281s, and they do the work fine. W5JA is using a 210. He is on Sunday ams and Saturday nights. W5BBF reports having trouble with the transmitter. His sked with W5BFY is over, due to W5BFY's being transferred to Arizona. W5BAD is in Dallas working for the Western Union. He is getting an 852 for work at Ennis this fall. W5EV a new ORS is also the new Route Manager for Northern Texas. He is putting out a circular letter and with your help, regular channels can be arranged and traffic moved easily. Get behind him fellows!

W5AAE reports heavy vacation is keeping his total down. He is on a 1500 mile trip through South Texas. W5ATZ has a portable call, W5GH, the GH being the same as his name. While visiting WBAP in Ft. Worth, he was made a presunt of a mercury arc tube by W5KL, the chief operator. W5BG is still building radio parts, but is on Monday nights and Sunday mornings.

Traffic: W5RJ 108, W5BAM 50, W5JA 17, W5BBF 13, W5BAD 8, W5EV 7, W5AAE 4, W5ATZ 4, W5BG 3.

OKLAHOMA — SCM, Wm. J. Gentry. W5GF — W5APG reports two skeds with n88NC. W58W has been busy with electric work. W5CB and W5JB are new ORS. Welcome, OMs. W5VH is a harvest hand. Hi. W5AZG went to CMTC. W5AYF is busy building a portable. W5ASQ was elected President of the IBPC. W5ALP is going to school in September. W5BEE is out of power supply. Hi. W5H is on 14,000 kc. and was elected secretary for J. B. P. C. FB. W5GF is still trying to get enough parts for that 250-watter xtal. Now, gang, let's keep reporting and give the SCM some news. Our West Gulf Division Convention will be November 22nd-23rd.

Traffic: W5APG 14, W5CB 13, W5GF 13, W5ALP 12, W5AYF 7, W5BEE 5, W58W 2, W5ASQ 1.

CANADA

QUEBEC DIVISION

QUEBEC — SCM, Alex Reid, VE2BE — Again we have to report a month of very poor conditions with bad QRN on the 7000-ke. band and bad fading and silent nights on the 14,000-ke. band. Our old reliable, VE2AC, breaks the section record again with a high total of 267, which gives him a place in the BPL for the sixth time. Alphy, who, by the way, is also our RM, has mailed a letter to every member urging us to keep on the air during the summer months and keep traffic moving. VE2BG is using a new circuit of his own, and has the prettiest note in this division. VE2HV has assembled his new gear and expects to be on shortly with increased power. VE2AL, VE2CA and VE2BE have been on when conditions warrant, and have got in some fair DX, but very little traffic. VE2BE keeps a weekly sked with NJ2PA in Jamaica.

Traffic: VE2AC 267, VE2BE 29, VE2AL 18, VE2BB 17, VE2BG 10, VE2AP 14, VE2CA 14.

ONTARIO

ONTARIO — SCM, E. C. Thompson. VE3FC — VE3VS working on 14,000 kc. worked a wonderful list of real DX and handled some traffic. VE3BT has a crystal-controlled transmitter working on 7000 kc. VE9AL on 3600 kc. again handled the most traffic. VE3CL

now has a real filter and a note to be proud of. His ambition is to work a VE5 station. VE3ET and VE3AR are both employed away from home, and will not be on the air again until fall. VE3FC clobbered with ZL2AC once again, July 6th on 14,000 kc.

Traffic: VE9AL 21, VE3VS 9, VE3CL 2, VE3BT 2, VE3FC 2.

VANALTA DIVISION

ALBERTA — SCM, E. J. Taylor. VE4HA — We just passed a nice DX period. VE4HM worked his first G. VE4EY gets his usual ZL and VK. Many of the gang are out of town enjoying well-earned holidays. We hope VE4O's family is all well again. If VE4GD and VE4AF keep up, we are going to have two more WAC in this section before long. Our real traffic star is VE4CC. He has nice skeds and knows how to take care of them. The SCM wants to thank VE4GD for his splendid support in reporting and would like a little more from the gang in the north.

Traffic: VE4HM 2, VE4EY 4, VE4EI 9, VE4CC 89.

PRAIRIE DIVISION

MANITOBA — SCM, A. V. Chase. VE4HR — Reports have taken a decided slump. VE4JB is attending the summer course at Stout Tech., Menomonie, Wis. VE4ZZ has built himself a push-pull TPTG xmitter and is receiving A1 reports on 7000 kc., but cannot get the xmitter to work decently on 14,000 kc. VE4BU has started up again with an inductively coupled Hartley of the 1929 High-C variety. He wants Q8Q with Winnipeg on 3500 kc. VE4HR has been heard in the Old Country and in New Zealand on 14,000 kc. VE4DJ is still in pursuit of DX. VE4DI is again building. He claims this xmitter will not be the last.

Traffic: VE4ZZ 3, VE4HR 2, VE4BU 1.

LATE AND ADDITIONAL REPORTS

W5AHI expects ORS appointment soon. W6DTU says there is DX, rag-chewing and plenty of traffic on 20 meters.
Traffic: W5AHI 53, W6DTU 283.

Traffic Briefs

Portable transmitters are now becoming the vogue with the warm weather. Amateurs who contemplate building such outfits are advised that there are two types of licenses for portable transmitters. The first is issued to a portable station that is to be used only within the boundaries of one inspection district. This type of license is issued for a period of one year. The second type of license is issued for a portable transmitter that is to be taken on one specific trip. If this trip takes the transmitter through other inspection districts beside the one from which the license is issued, the license can authorize operation within the other inspection districts concerned. This type of license expires with the conclusion of the trip for which it is issued.

General bad conditions brought about by the hot summer weather have called a halt to the Beginners' 1750-ke. Code Practice Program. With the coming of fall and the return of good radio weather, this activity, which proved to be so popular during the past radio season, will be resumed.

The College Amateur Union has invented a combined checkerboard and chessboard that has several features to recommend it for general use among amateur checker and chess circles. The plan of the board is printed below. It will be noted that the scheme operates in a fashion similar to any standard map. To locate a given square on the board, it is necessary only to follow the line of squares to the right of and immediately below the square that is in consideration. For example, the square marked "DK" on the diagram is found to be opposite "K" (to the right) and immediately above "D" (below). Thus it is designated as "DK." When a move is to be designated, it is necessary to say, for example, "DK to DN," which would indicate that the piece resting on square "DK" was to be moved to square "DN,"



I.A.R.U. NEWS

Conducted by A. L. Budlong

THE W.A.C. CLUB

AS probably most of the readers of *QST* know, those amateurs who, with their amateur transmitters, have succeeded in working all the six continents of the world, are entitled to membership in the W.A.C. Club.

W.A.C. certificates are issued by A.R.R.L. Headquarters. To obtain one, an amateur should send to the League QSL cards confirming two-way communication between his station and stations in North America, South America, Europe, Asia, Africa and Oceania.

Just what constitutes Oceania seems to be a source of some trouble and worry to many amateurs who petition for W.A.C. certificates. For the information of all readers, we will note

It may be of interest to know how many W.A.C. certificates have been issued so far. At this writing, 272 certificates have been sent out. North America leads with 141; 61 are in Europe; 29 in Oceania; 22 in South America; 14 in Africa, and 5 in Asia.

In the United States, the sixth district leads all others with 49 certificates. Next is the first district, with 20, and after that the 5th, with 15; second district, 14; ninth district, 12; seventh district, 8; third district, 5; fourth district, 4; and the eighth district with but 3.

For Europe the distribution is as follows: England, 29; France, 7; Portugal, 5; Belgium, 4; Germany, Italy, Holland, Denmark and North Ireland, 2 each; and one each to the Irish Free State, Jugoslavia, Austria, Czechoslovakia, Spain and Norway.

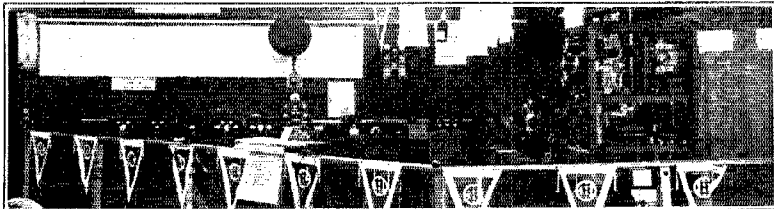

THE TRANSMITTING AND RECEIVING BOOTH OF THE N.V.I.R. AT THE HAGUE RADIO EXHIBITION

that the following are classified under the heading of Oceania: Australia, New Zealand, the Philippines, Hawaii, Java, Sumatra, Borneo, New Guinea, the Celebes, and the Samoan, Fiji, Solomon and New Hebrides island groups.

Some hams feel that Java, Sumatra and the Philippines should constitute an Asiatic contact because they are so near Asia. We are afraid we can't allow this. Every atlas we can find lists these places as part of Oceania. Oceania they are and Oceania they must remain. To argue that they should count as Asia because they are near that continent is equivalent to saying that southern Spain should count as Africa because it is only a stone's throw from that continent (so to speak) across the Strait of Gibraltar.

In South America, four countries are represented on the W.A.C. rolls: Brazil leads with 9, followed by Chile with 7, Uruguay 5, and Argentina 1.

Other certificates are scattered throughout the world as follows: Australia, 20; South Africa, 14; New Zealand, 7; the Philippines, 5; China, 4; Hawaii, 3; and one each in Canada, Straits Settlements, Tasmania, Jamaica, India and Porto Rico.

It may be stated in closing that one of the requirements for the issuance of the W.A.C. award is that the applicant must be a member of the A.R.R.L.

If you comply with all the requirements, shoot in your cards, and get your certificate. We still have plenty on hand, OM's.

Last month we mentioned that some amateurs were using amateur QSL cards as a means of disseminating class propaganda, and urged strongly that such things be kept out of our international hobby.

In the meantime it has come to our attention that a certain European society is writing to most of the other amateur societies of the world

ernmental departments from an attitude of hostility to one of friendly coöperation. In this they have succeeded — how well can be appreciated by those who are fully familiar with the circumstances.

We congratulate our member-society in Holland, and through it offer congratulations to all Holland amateurs.

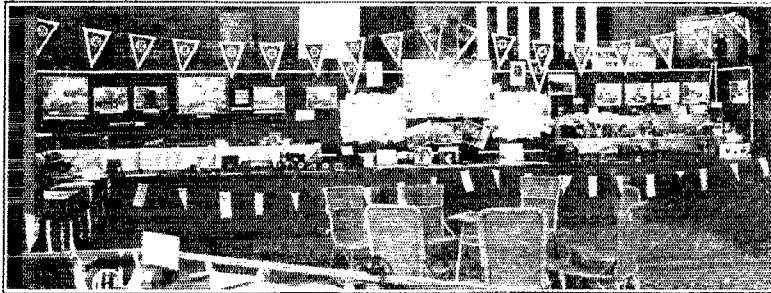

THE STATIONERY BOOTH OF THE N.V.I.R. AT THE HAGUE SHOW

urging that they refuse to adopt the new prefix system prescribed by the Washington Conference, and continue to use the old I.A.R.U. international intermediates.

Union headquarters deploras this action, and trusts that no amateur who has been officially instructed by his government to use a designated prefix will disregard such instructions and use the old intermediates. The question of relative convenience has nothing to do with the matter. If we amateurs are to secure recognition at future international radio conferences, we must show ourselves to be law-abiding and worthy of such recognition. International prefixes have been agreed upon by the authorities of most of the nations of the world as the means of designation of amateur nationality. The members of the Union, and most of the other prominent national societies throughout the world are using these prefixes. The petty gesture of any small group to disregard them accomplishes no good and merely tends to put amateurs as a whole in disrepute.

Forget it!

At last! Word has just come through that the Dutch hams are now going to be licensed, and that, furthermore, the license regulations are favorable. This is a splendid tribute to the efforts of our Dutch co-workers. For years they were discouraged at every turn by official restrictions. It is doubtful if the amateurs of any country anywhere were "up against" any harder proposition than were those of Holland. In spite of this, they banded together, formed a splendid organization, the N.V.I.R., and set to work to convert the gov-

Part of the story of the new era is told in the following report from Mr. W. Keeman, Traffic Manager of the N.V.I.R.:

HOLLAND

Two great events are lying behind us this month. First was the third annual radio exhibition in the Kurhaus at Scheveningen, near the Hague (Hague-on-sea) Holland. The second,



THIS IS THE GANG THAT PUT OVER THE N.V.I.R. EXHIBIT

(Never mind that sign in the background!)

even greater, was the coming of amateur licenses for Dutch hams. A full copy of the requirements will very shortly be forwarded to Union headquarters, but the essentials are as follows: Amateurs will have to pass an examination by a commission, consisting of two officers of the postal department, and two amateur representatives. We hope that the next copy of the official call books will contain a long list of Dutch names!

The N.V.I.R., the Dutch section of the I.A.R.U.,

(Continued on page 84)

Calls Heard



W. A. Bousfield, York St., Bellerive, Tasmania
14,000-ko. band

w1anz w1asu w1gf w2bjd w2bpm w2cl w2gd w2mb w3rr
w1aqi w3bek w3bjm w3buf w4abw w4akh w4aew w4ab
w4uv w5aec w5aep w5aew w5ayu w5beq w5rg w6aaz
w6adp w6ags w6ajm w6aqj w6aqg w6ary w6awp w6bam
w6bax w6bhw w6cuh w6dts w6dyo w6dzi w6dzy w6uz
w7abg w7afo w7aky w7if w7nr w7om w8adm w8apb w8cew
w8dza w8ez w9aid w9axg w9bqc w9dgs w9dir w9fjx celah
ce3ac ce1na ce1aa ce1bx d4cb d4uj eu3am f8aap f8cj f8ceo
f8sep f8dmf f8dot f8eo f8er f8faf f8fd f8fk f8fr f8gdb f8hcl
f8he f8ho f8hr f8hz f8klm f8kz f8lx f8lu f8orm f8pag f8pro
f8rko f8ami f8xs g2cx g2lz g2nm g2xy g2zp g2od g5by
g5bz g5ml g5mq g5yz g8hp g8rw g8wo g8wy g6xc g6xn
g6xj g6xq g6yq j2by j4gn k6bxw ok1fm oz7ly paofp paocf
paovn paowr pb7 on4dv on4ea on4ie on4fp on4ft on4uu
onevu rx1aa rxfdr5 su8rs ve4go v9a v1mdz ex1na

G6YL, Miss Barbara Dunn, Felton, Northumberland, England

w1aje w1aof w1eql w1oxl w1kh w1nn w1on w1rp w1wf
w2bhr w2it w2ku w2tr w2xz w3apf w9dh w4aev w4ar
py1aw kfr0 y1zqy y1zad if5er 55x

FK6CR, Clyde Demina, W60J-W6ZZK, Lake Albert, Uganda British East Africa

7000- to 7300-ko. band

w1abt w1ack w1atz w1ad w1aue w1mk w1rp w1si w1sz
w1vr w2aeg w2apv w2heo w2bf w2bda w2cwf w2bhv
w2cd w3anh w3aws w3bnu w3bee w3nt w4oc w4pf w4zp
w5bq w5bfy w8ake w8axz s8bts w8cau

VU2DF, S. N. Kabra, c/o The Wireless House, Ram Galli-Lahore, India

a15vx aulap aulak aulac aulal aulao aulaa aulb au8kac
au8ae au8an au7ao aural 3b4fe euk6ag g5bg oh2nm
on4fm y1ilm z55d z55e af1b

W. Clyde Townsend, S.S. Dromore Castle, Union Castle Mail S.S. Co., 3 Belmont Road, Southampton, England

Heard at Capetown, South Africa

w1rp w2oxl w2wy w4aj w4oc w5afu w5bhe w5bex w5bfy
w5je w6ahp w6akw w6ari w6blk w6bpc w6bik w6cjh
w6cui w6ovv w6ozn w6djj w6dli w6drb w6dtp w6drd w6ea
w6eb w6edo w6edx w6ekr w6eru w6ft w6hs w6ju w6yh
w7aer w7df w7ep w9cww w9cxw w9dbj w9fgo w9um az2if
au7kad au7kzn ct1br ct3am ov5as d4ld d4ia d4ux ear2l
e8rft eu2cg eu3kak eu5kwd eu5pl eu6am eu8kag f8dg
f8hyl f8zk g5by ilek klom kljr klfr k4dtg nijn oklvp
ok4io on2nc on4gg on4ia on4je on4is oz1d paocaa rwx
sp3ar nrj w6awp w6dsg w7fk w6wh w6ery w9wl ct1aa
ct1tt f8aap f8df f8eo f8gsb f8prd f8k4ms g2vi g6rp on4bt
on4dv on4fb on4uu onva pa1vn sm6ua vk3zd vk5hg xw6wl

OKRP19, Alois Weirauch, Mestec, Kralove, Czechoslovakia

w1szj w1akx w1asu w1aqf w1axa w1csc w1cwl w1cek
w1cel w1ofi w1oje w1omx w1dq w1ii w1mo w1mr w1we
w1zz w2acu w2afe w2ag w2ake w2amm w2arm w2ary

w2atf w2afx w2chn w2cjj w2ceg w2eou w2evi w2el w2gp
w2hj w2ju w2mc w2ejh w2rr w2rs w3axx w3adm w3ajf
w3aqs w3ep w3de w3ep w3ln w3pf w3nt w3wm w4aef
w4aha w4we w8ddl w8tdm w9ell ar8ufm au7ac au7ca
au7kad celah celav ce2ac ce3ac ce3ef em2jt cn8cm ct2aa
ct3am cx1na cx1ev fm8gko fm8kik fm8rit fm7unl k4kay
k4aan k4kd k4ni kfr5 lu2ca nj2pa pylaw pylcl pylca pylca
pylem py2ag py2ad py2ce py3ah su8as su8rs velap
velar ve1er ve1co ve2al ve2ce ve2eg ve8ae vo8mo vu2dr
vu2kt z14ao z54m xf8wo xpa0ja

W6MZ, Erich G. Mahn, S.S. "Hollywood," Bahia Blanca, Argentina

14,000-ko. band

w1bdi w1fn w2alu w4af w4ei w4nl w4pf w5ats. w5gr w5pa
w6abk w6ahz w6akw w6alw w6bgh w6blw w6buw w6byb
w6cda w6ech w6cha. w6cnn w6czz w6cxy w6dgr w6dqv
w6dvd w6dza w6ee w6ehf w6eiv w6ekm w6elr w6elz w6emx
w6eta w6eox w6erk w6na w6qk w6yh w7abk w7aim w7mb
w7wl w8bae w8bek w8cem w8ddl w9ale w9ant w9axx
w9bez w9dn w9dxx w9ceo w9eey w9eho w9epg w9evt
k7aok ve5eo h2hv

A. Edwards, 7 Sherbourne Road, Acocks Green, Birmingham, England

14,000-ko. band

w1adw w1asj w1bkr w1bqs w1cje w1cjj w1cmx w1enc
w1erw w1da w1dq w1ba w1ii w1mo w1ry w1sf w2aeb
w2ahz w2arb w2ary w2atz w2bkg w2biv w2dab w2fl w2bjw
w2jn w3age w3awb w3bft w3bph w3ab w4cq k4ni w6awm
w6bam w6bax w6fk w6kj w6lb w6rb w6uf w6wd w7afo
w7alw w8adm w8aur w8avd w8avs w8eit w9bma w9erb
w9drk w9etd nj2pa kfr5 pylaf pylbe pylbi pylbr pylcn
py2ad py2az py2bc py2il lu2ca lu2fi lu3de lu6fd lu8dj
celah ce3ac ewe2 zp7ab en8ie oa4o oa4q em2jt ex1ci
vk3bq vk3kb pk4az qpmp y12as ok2et y1mdz fm8gko
fm8rit eu2bf sp8ew haf3xx haf3ca hafinn haf3av vw4ab
au7ab xau2bj xoz7gu xf8pb

WSAVW, B. L. Capstaff, Demerest Road, Butler, N. J.

3500-ko. 'phones

w2ry w2fr w2adi w3ae w1auz w8abe w8osa w2awo w8ayg
w2bey w2aex w2bld w2aiq w22n w2gj w8aai w1awo
w2ma w8eza w2af w8pk w2at w1cjd w2bse w2jj w2bma
w2bij w2zz w2bbk w3ba w2aed w2vi w2ako w2ain w2aoo
w3alq w2aaj w2iu w2bee w2ji w2aes w8cjt w8atd w3abn
w1auy w3oo w3cgg

W9UM, M. W. Macy, Lake Wawasee, Syracuse Ind.

w6abr w6ad w6aey w5afp w6akm w6akw w6am w6ap
w6awa w6awp w6awy w6ax w6axe w6ayc w6bam w6bf
w6bhi w6bip w6bjf w6bjl w6bjq w6blu w6bpc w6bro
w6bts w6bvm w6bwi w6byb w6byh w6bza w6cal w6cbz
w6cci w6cgg w6chq w6cjs w6cla w6cns w6cpt w6crx w6ery
w6etd w6euh w6ezk w6ezz w6dis w6dlu w6dhw w6die
w6dju w6djw w6dix w6dlg w6dli w6dms w6doj w6dqj
w6dag w6dtd w6dvd w6dwp w6dyl w6dza w6dzy w6eeg
w6eiv w6egh w6egr w6eif w6ekr w6ekz w6elm w6emg
w6eol w6eo w6eop w6epe w6eqb w6qd w6err w6eru w6esq
w6ete w6ft w6ke w6az w6ql w6si w6wn w6xbb w7abb
w7aby w7ad w7ach w7ah w7ahh w7ahk w7aja w7ajs

w7bb w7asb w7el w7iy w7li w7lz w7om w7pp w7rz w7st w7ts w7va w7wi w7zz w7xu vk2rb vk3jk vk5gh vk5wh velap velbm velda ve4dj ve4gd ve4jg ve4hd ve5az ve5ej ve5ee rx4fn nr2jg nr2wd nr2hc cm2ay cm2eo cm2ac cm5az cm5fc cm5fl cm5ni f8dt d4uj g5by k6dv k6dpg k6ejs nj2pa x9a x9b x29a zilft zilfw z12ag z14ae z14am nuxx nnnic nu3nic nu1nic nu7nic os4o zs2b kd5v kfr5 kfr6 kfil wibt wfa w2gm at sea z12go

FSKZ, R. Dezerville, 46 rue Saint Laurent LAGNY sur Marne, France

7000-kilocycle band

w1acv w1arg w1efi w1emp w1fw w1ky w1xi w1ln w1mv w1pd w1pe w1si w1sz w1wu w2bcm w2bia w2bif w2blx w2jc w3afw w3bph w3kj w4eef w4ft w4rn w8bbp w8uk vk5sg vk2rb velda

14,000-kilocycle band

w1aci w1aep w1ahi w1apq w1asj w1asu w1awe w1awf w1aze w1bal w1bed w1bif w1bux w1bkr w1eaw w1jg w1ue w1py w1yb w1zz w2amr w2aql w2bdr w2biv w2bjl w2bjg w22bkg w2boa w2ch w2cix w2evf w2evj w2dk w2hj w2jn w2ndk w2rs w2uk w2ws w3acx w3adp w3aur w3ahh w3aac w4aei w4aq w4iz w6bw w7aav w8abm w8axa w8bej w8buh w8eow w8enh w8dij w8dre w8dyi vo8er velap velen ve2ac ve2ed ve3hb vk3rx vk5hj vk5gh pyltl pylah py2ad z5u z5rm z12aw z12ag z14ae z14ba piljr pk4az fk4sm fk5er k4ary fikol f1ib y1lmdz

28,000-kilocycle band

w2jn w2nl w2evj wukr

W9DLY, Clayton S. Walrath, White, S. D.

14,000-kilocycle band

py1aa py1ah py1at py1aw py1bl py1el py1fi py2af py2ak py2bg celah ce2ab ce3bf lulez lu2bx w2ay g5hd g5by g6bh g6qb g6rb g6wy g6xc on4fp on4ft on4gn on4uu et1aa pa0fp e8ep f8er f8fc f8hr f8swa z11ao z11ax z11fb z12aw z12bg z13be z14ae z14ao z14ax z14ba vk2lm vk2rx vk2tw vk3ep vk3ga vk3go vk3ot vk5gh vk7ch ah1 bx fqpm k6bxt k6dpg k7mn nj2pa nr2ea rxf5 rwx wfat xj xwl x7eff

7000-kilocycle band

k6eja kd5v z13cm vk2ac.

W6CHV, R. H. Culbertson, Escondido, Calif.

w1efi w1er w1etx w1evu w1if w1im w1le w1mk w1si w1sz w1ve w1yb w2aeg w2agp w2ar2 w2ba w2aya w2beh w2bda w2bhy w2ek w2evu w2el w2ap w2hc w2hn w2kb w2me w2qy w2uk w2rz w2za w2ac w3aim w3ard w3arp w3aws w3bwt w3hi w3ky w3pf w3pt w3ut w3su w3vb w4aaq w4abw w4ae w4afk w4ahl w4ahq w4aij w4akg w4ale w4aq w4bh w4ci w4ie w4if w4hm w4mb w4nl w4oz w4ut w5aak w5ach w5adp w5ain w5akg w5aly w5amg w5aml w5amo w5ana w5aoz w5ati w5ayl w5bah w5bca w5bde w5bek w5ben w5bf w5bfb w5bft w5ec w5dex w5fo w5gr w5jk w5mx w5pa w5rg w5rh w5qa w5qe w5qy w5uf w5zg w5ww w7aao w7abx w7aby w7aci w7aga w7agp w7alc w7alm w7am w7ao w7aoo w7eq w7ex w7eb w7fa w7ft w7fh w7gc w7gl w7hx w7id w7im w7kt w7nr w7om w7pp w7pv w7pz w7rr w7ts w7vk w7vq w7wt w7z w8aar w8adu w8alh w8bap w8bek w8bh w8hl w8bm w8bte w8bft w8be w8ea w8onx w8enz w8epq w8dem w8ddk w8dfk w8dpo w8dps w8dyj w8fz w8uk w9abd w9ael w9aco w9afj w9anf w9aof w9ayu w9be w9bfo w9ban w9bbh w9bkl w9bwm w9bww w9bz0 w9ce w9cet w9ejg w9emq w9erd w9erj w9erm w9evd w9eye w9da w9dfy w9dkg w9dpl w9dpe w9dvw w9dws w9dxl w9dyv w9eaj w9ebt w9edk w9eey w9efk w9egj w9eij w9ej0 w9ek w9eph w9erb w9ert w9eyd w9evk w9fem w9fiz w9fnu w9gb w9gcx w9gfo w9ght w9gis w9ir w9if w9jl w9ka w9ld w9lk w9tj w9ur w9pn w9pv w9um w9xi cm5sh klom klhr k6alm k6ayl k6efq k6db k6dju k7ljv xea1 xebi x29a dn3 vce4j

W9AJA, Neil Werner, 436 21st Place, Hammond, Ind.

ce1ah ce2ab ce3ab ce3ac cm2cf ct1bx ct1aa ct3ab dn3 ex1ev fqpm f8eo f8fc f8hr g5by g5yg g5yo g6up g6wy g6xq k4aky k4ni k6alm k6eat k6ene k7mn lu2ca lu3de

lu8dn nj2pa nr2ags nr2ea os4h os4s os4o on4ar on4fp on4gn oklfm pylaa pylaw pylap pylbe pylbl pylcm pylcd pylid py2ak py2al py2ax py2el py2ih rxf5 r1aa su8rs vk2op vk3pm ve1ar ve1ap ve2am ve2ay ve3ur ve4af ve4as ve4eb ve4fb ve4ha ve4hu vo8ae zilax z12ac apl umbx xf8wb xpa0ja xpa0zx xpa0zz

W2ATZ, Eric H. Palmer, Jr., 305 Ave. C. West, Brooklyn, N. Y.

14,000-kilocycle band

w6aaq w6dwp w6dtu w6btz w6ebp w6eoz w6drb w6ad w6avj w6bam w6ehb w7ek w7aj w7afo w7le w7akp pylaw nj2pa vo8ae vo8azw ct1bx ct3ad f8fd f8fk f8jm f8eo f8ba f8px f8ct f8aap f8aej f8swa g2xv 25ml g5by g5bz g6xc on4fp rwx waq paoga oklfm ys1fm fqpm ceeur65 vk4oo z14ao kdzw kdjz fq8hpg k4kd g6ll sa-dq4 selai wiat

VK3CX, Alan G. Brown, 8 Mangarra Road, Canterbury, E7, Victoria, Australia

14,000-kilocycle band

w1aep w1adz w1bux w1eek w1cje w1cmx w1cqr w1eri w1dq w1fk w1ry w1ow w1we w1zz w2aof w2aql w2bdr w2bjl w2bvq w2el w2fp w2gp w2jn w2mb w2tp w3aqs w3cee w3ah w3ut w4aef w4eq w5aot w5rg w5ux w5yq w6aq w6ary w6bam w6bax w6bc w6bw w6k w6hy w6rpm w6tuh w6wzm w6dhs w6drb w6dtz w6efe w6gy w6wn w7aav w7afo w7agb w7dd w7if w7ur w8amh w8axa w8enz w8era w8dij w8zg w8kc w8of w9aas w9bga w9bqw w9che w9cok w9dgg w9dku w9dly w9dqo w9ef w9eh w9fb w9fw w9hy w9ka wfat wftt klaf klcm k4ni kbav1 k6clj k6dpg k6cha k7mm kfr5 celah celai ce3ac ex1ao d4yt earl ear65 ear96 f8aap f8ajg f8axq f8btr f8fr f8j f8orm f8rko f8rr f8wb f8xz g5by g5bz g6ml g5vk g5qv g6hp g6vj g6vp g6wl lx2nu lu3dq oa4l oa4o os4s pk1bh pk1jr pk4az pylcm oh2nm oh2na on4di on4fe on4fp os1aa ve2ul ve2ax ve2bg ve2ca ve3dg vu2kt vu2kw vu2yx vu5vx vs3ab vs3qg x9a x9b y1aa y1llm

WSAQ, E. H. Gibbs, 121 W. North St., Wadsworth, Ohio

14,000-kilocycle band

ce1ah celai ce2ab ce3ac ce3bf ce3ej ct1aa ct1bx ct1by ct3ab ear98 f8aap f8aej f8bl f8btr f8ct f8dmf f8eo f8fd f8jgq f8jgb f8lx f8mat f8pam f8orm f8swa f8xh f8ypp g2qv g2zv g2zp g5bj g5bz g5lv g5ml g6wy g5xc g5yk g6bd g6dh g6gb g6rb g6uw g6vp g6wy g6xb g6xj g6xn g6yq g15wd ilao lulez lu2li lu3hi lude lu8de on4hu on4di on4fp on4ft on4gm on4ro pa0fr pa0wr rx1aa su8rs vk2hc vk2jy vk2zs vk2rx vk3lp vk3jr vk4bb vk4bh vk5hg vk7ch vo8ae x9a y1aa zilfb z12ac z12aw z12be z12bx nr2ags fqpm umbx nlgren rwx xf8hpg xf8wb xpa0zz w7eff

W2LG, SS Aguiristarr, enroute Talcahuano, Chile, from Balboa, Canal Zone.

w1fr w1fi w1mk w1pw w1rs w1sz w1xc w1xm w1yb w1aaf w1aed w1aeh w1afz w1agk w1aje w1ajx w1are w1arg w1asp w1axx w1azd w1bdi w1bdq w1bgq w1bks w1ci w1erw w2dn w2ew w2fc w2fy w2jt w2mq w2ms w2nj w2ov w2pv w2qu w2ra w2rs w2sf w2sm w2tn w2tr w2wr w2wy w2aao w2aeg w2afz w2au w2amt w2anm w2apv w2aqc w2aub w2auk w2bfi w2bgb w2bgm w2bhn w2bia w2bim w2bkg w2bmm w2eed w2ohb w2oin w2ovj w2evu w2exl w3lp w3pf w3adz w3afx w3aim w3aks w3anf w3anb w3aqp w3arp w3ato w3atw w3awm w3bhm w3bhz w3bnu w3bsm w3cee w3cej w3ceo w4ac w4aq w4be w4bt w4bz w4ct w4cz w4dv w4ei w4fo w4ky w4ly w4ll w4oo w4ok w4rb w4rh w4to w4va w4we w4wb w4cc w4ack w4acz w4adf w4af w4en w4eo w4efk w4gl w4ag w4aha w4ah1 w4ah2 w4ahs w4aij w4ajr w4akq w4aqw w4beu w5ae w5az w5bn w5df w5gg w5gi w5je w5hn w5je w5jo w5mm w5mx w5nd w5oh w5ot w5ox w5pa w5rd w5rg w5aar w5ach w5adv w5aep w5afg w5ain w5aqc w5ara w5atf w5awd w5awq w5axs w5ayb w5bay w5bcx w5bej w5bdg w5bek w5bfq w6ap w6ax w6bl w6by w6cu w6ft

(Continued on page 68)

Correspondence

The Publishers of QST assume no responsibility for statements made herein by correspondents



A New Slant on 'Phone Reception

Wichita Falls, Tex.

Editor, QST:

Have just finished reading "More About 'Phone" in the Correspondence column of the May QST, where Mr. Heald, Jr., of Spencer, Ia., takes the 'phones to task. Much is said, and in concluding, Mr. Heald says that very nearly all 'phones have the same horrible distortion, and asks if it is exceedingly difficult to adjust a 'phone transmitter so that the output will sound anything like the input signal.

His letter caused me to chew the back off of QST, and I got down to page 15 before I could be reconciled. After regaining consciousness, I began reading the description of a wonderful 1929 'phone receiver, all of which gives me the idea that something should be done.

Back in the days when the League denounced radio telephony for amateurs, I was one of the amateurs who clamored for its recognition, but today, thanks to the foresight of the Directors and Executives of the A.R.R.L., the columns of QST are now free and accessible to us amateurs who find the very thrill of the amateur game in handling the intricate audio frequencies which are mingled with radio frequencies for transmission.

To be sure, it takes money and apparatus aplenty for a good 'phone; also it takes work, patience, and a working knowledge of radio telephony. With the assistance of the A.R.R.L., we hope to rid the air of wretched 'phones that now infest the bands and substitute in their place 'phones which will radiate the very personality of their operators, and develop apparatus which can command and maintain the respect of the modern broadcasting stations.

During the winter of 1928 and 1929, two hundred enjoyable and nearly perfect QSOs were completed with a receiver having an audio end suitable for 'phone reception. A two-way contact in the 1750-kc. band was made with Canadian 9AT with loud speakers in use at both ends. In most of the instances, modulation was fair, and in some instances excellent. In fact many amateur stations were using the broadcast equipment which the operator either worked or owned, the wavelength being temporarily reduced for operation in the amateur band.

Let's do a little reasoning, gang. Don't try to listen to the 'phones with your telegraph receivers, and before making any complaint about

'phones, let's be sure the receivers we use are capable of an output which is nearly like that of the input.

— Wm. E. Archer, W5AAG

Another QSLL Suggestion

6452 Hayes Drive,
Los Angeles, Calif.

Editor, QST:

In the March issue of QST, Mr. Howard T. Chasman gave us a new slant on the QSLL situation. His remarks would lead us to believe that he is a statistician of the "swivel chair" type. He takes the absurd hypothesis that IF he could QSL everyone with whom he makes contact it would cost him thirty-six dollars a year and eight hours a month out of his operating time. I do not question the validity of the statistics presented, but what I would like to know is, who is *expected* to QSL everyone worked?

If one is really in earnest about not desiring to QSL, the only fair thing to do is to return the card to the sender. It doesn't cost a cent. All that is necessary to be done is to tell the postman that you refuse to receive said mail, whereupon the card will be stamped "REFUSED" and will be returned to the sender. The other operator, when his card is returned to him with the reason for non-delivery stamped all over it, will suddenly be smitten with a vague shadow of a suspicion that perhaps his card was NOT wanted.

When I receive a card which I accept, I make it my duty to return the compliment. It is no more than common courtesy to the other party. Let's have some more comment on this QSL situation, fellows, and see if we can relieve the hard feelings already in existence.

— I. S. Limer, W6EIZ

"Nil Hr Now, Cul—"

Bellmore, N. Y.

Editor, QST:

We talk much of d.c. notes, crystal-controlled, 1929 practice, and key thumps. We spend weeks of patient effort to smooth out that last little ripple and eliminate that last little chirp. We cut and try, string wires, read meters, and swear to give our signals a firm start on their journey around the earth.

W2XV

owned and operated by Radio Engineering Labs.

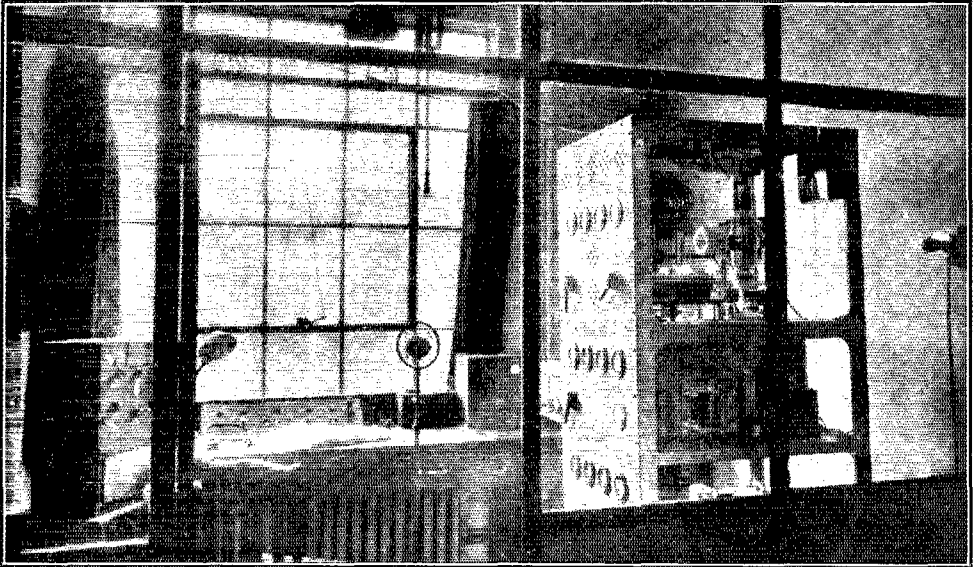

Operates experimental station W2XV on various schedules to determine the qualities and efficiency of REL short wave receiving and transmitting equipment. This station employs the most modern features in both the transmitter and the receiver. Most of the individual parts employed are standard REL apparatus exactly the same as that which is finding more and more increased popularity in every well known short wave station. The worth of REL parts

are proven in actual operation and any defects can be readily uncovered and corrected. W2XV is working for you, that is the story we want to tell.

A brief description of W2XV is as follows: The operating room is completely enclosed in glass and located in one corner of the testing laboratory —

THE TRANSMITTER is crystal control with thermostatic heat regulator — employs either telephone or telegraph — 100% system of modulation — final power amplifier 750 watts output — complete shielding — rigid cast aluminum end frames with heavy sheet aluminum panels and sides.

THE RECEIVER employs short wave super hetrodyne circuit — untuned screen grid RF stage — screen grid intermediate amplifier stages — frequency calibration for each plug-in coil — completely shielded battery compartment.

THE MASTER CONTROL PANEL mounts directly in front of the operator on the operating table — pilot lamps indicate all major circuits.

THE STATION AMPLIFIER is used in conjunction with two button microphones — A phonograph turn table (directly behind transmitter) also feeds into the station amplifier.

THE POWER SUPPLY for all of the smaller tubes in the transmitter is derived from rectified AC — plate supply to the 75-watt and 750-watt tubes is obtained from 4000-volt motor generator unit — motor generator unit remotely controlled.

Transmission from W2XV is within an accuracy of 100 cycles of the specified frequencies. Use this for a frequency check station. The following schedule is in effect for the balance of 1929.

12:00 NOON to 1:00 P.M. — Aug. 26th to Sept. 13th	8650 KC.	1:00 to 2:00 P.M. — Nov. 18th to Nov. 29th	8650 KC.
7:00 to 9:00 P.M. — Sept. 16th to Oct. 4th	8650 KC.	4:30 to 5:30 P.M. — Dec. 2nd to Dec. 13th	8650 KC.
11:00 to 12:00 A.M. — Sept. 16th to Oct. 4th	17300 KC.	10:00 P.M. to 12:00 MIDNIGHT — Dec. 16th to Dec. 20th	8650 KC.
3:00 to 4:00 P.M. — Oct. 7th to Oct. 25th	17300 KC.	9:00 to 10:00 A.M. — Dec. 23rd to Jan. 3rd	17300 KC.
7:00 to 9:00 P.M. — Oct. 28th to Nov. 15th	4795 KC.		



You are invited to listen in — Please let us hear from you
 manufactures a complete line of apparatus for short wave transmission and reception. Write for Bulletin Z

Radio Engineering Laboratories

100 Wilbur Avenue, Long Island City, New York

Power Amplifier help for Public Address system ENGINEERS

YOU know exactly how important the Power Amplifier is in any P.A., or similar installation.

You know how hard it is to secure a Power Amplifier with a flat curve extending from 25 to 8000 cycles, without resonant peaks at any frequency!

You know exactly what you want . . . what you need. And you know how hard it has been to get.

Into the pages of a NEW book on Power Amplifiers, designed by Ferranti Engineers, there is packed more helpful information than ever before given on Power Amplifiers.

Diagrams and Components enabling you to build ten different Power Amplifiers from a 1-stage using 171 tube to a 3-stage using 250 tubes in push-pull are part of this helpful volume.

Solve your Power Amplifier problems by sending T-O-D-A-Y for Ferranti's Power Amplifier Book.



130 West 42nd St., Desk 89, New York, N.Y.

Ferranti, Inc.
130 West 42nd Street, Desk 89
New York, N. Y.

Enclosed is 15c, in coin, for which send me your NEW Power Amplifier Book. Money to be returned if I ask it.

NAME _____
ADDRESS _____
CITY _____ STATE _____

Boys, it's great, after all our patience, all our effort, all our stringing of wires, and all our swearing, to hear an Australian answer our call on some calm, cool morning, as the dawn is breaking in the east. The other side of the globe — and talking to us! We, in our snug Long Island home, or our wood shed out in Kansas, are in conversation with far-away New Zealand, or a hut on the plains of Western Australia.

There are many things to say; many questions to ask! How does the other fellow live; what does he do to pass the other sixteen hours a day; is he a lawyer, merchant, or a herder of sheep? What does his part of the world look like? Yes, there are many things to say; many questions to ask; a new friend to make across the earth; tales to tell. Here we sit, in our own home, in our own easy chair; there he sits, across the fireside, so to speak, our guest from a strange land. Ours is the joy to welcome him, with some interesting stories about the things we know; his, the pleasure of responding with tales of his own land.

And, what do we really say?

"Your signals vy fb OM. Gud d.e. note and stdy. Not much fading. Hw do I cum in over there? Nm no, OM, so cul. Cheerio, 73, GN."

Why, it's like welcoming an old friend in the evening with a hearty handshake, a slap on the back, and, "You're looking well, old kid. Isn't the weather lovely? Now it's bedtime. Sorry. But you'll find a hotel around the corner. Very comfortable, I'm sure."

Yes, for all the talk of raw a.c., swinging signals, and rotten fists, our stations function rather well. We are in touch with the four corners of the earth (Heaviseid permitting). What a chance for international friendships!

Let's learn the gentle art of radio conversation.

— Cliff Himoe, W2AW, ex-WNP

A Newcomer Speaks

3838 Weston Pl.,
Long Beach, Calif.

Editor, *QST*:

A few months ago the undersigned commenced reading *QST*, learning the code, and accumulating meters, condensers and whatever looked to be usable in a ham station. From reading some of the letters in *QST*, it was evident that a beginner could not expect any silver-tongued orator of the key to come down from the rostrum and enjoy a pleasant three hours' conversation with a slightly deaf graduate of some stammerers institute.

As I expected nothing more than the warmth and cordiality accorded Mrs. Gann, I certainly was due for a pleasant surprise. Everyone has been friendly, and particularly, M. L. Smith, a Western Union operator for the past twenty years, who slows up for beginners at W6EAF, Independence, Cal. By a chance appointment, W6EAF pounded out one-way code, 300 miles away, for weeks with only an occasional postcard of thanks. He also answered questions with an accuracy that would make any reputable correspondence school truly envious. Thanks to his en-

SM

New S-M Custom Receiver Designs Shatter All Records

Single Control

Perfect convenience in operation, with a tremendous gain in selectivity and sensitivity—that's what has been accomplished in the new S-M receivers. Newly developed shielded coils make possible, with straight single control, a degree of selectivity never before achieved, even with multiple controls or verniers. One tuning control, one volume control, an on-off switch—that's all. All these receivers have push-pull 245 output stages, and both broadcast receivers embody the latest band-selector tuning.

All-A. C. Operation

These receivers are absolutely all-electric—even the 735 short-wave set, the first of its kind ever offered on the market. Power supplies are built into the receivers—not separate. The full advantages of the new a. c. screen-grid tubes are secured. The characteristic superior S-M tone quality, distance-range, and selectivity are in these receivers as never before, due not alone to band-selector tuning but also to still greater refinements of design and accuracy of manufacture.

S-M Speakers and Power Amplifiers

Nothing more beautiful in sound reproduction has ever been heard than the new S-M dynamic speakers, when supplied from a powerful S-M push-pull audio amplifier—giving straight-line amplification from 5000 cycles down even to below 50. These new medium-voltage high-power two-stage amplifiers, using 245 tubes in push-pull are built into the 722 and 735, and an extra high-grade Clough-system amplifier is obtainable separately, as the 677.

Beautiful Cabinets

The handsome new 707 table-model shielding cabinet, finished in rich crystalline brown and gold, suitable for 722, 735, or 735DC, is only \$7.75. Special arrangements have also been made whereby these receivers may be housed in mag-

nificent consoles especially adapted to them. Be sure to send for the new Fall S-M General Parts Catalog, for details of these cabinets.

722 Band-Selector Seven

Providing practically all 1930 features found in most new \$200 receivers, the S-M 722 is priced absurdly low in comparison. 3 screen-grid tubes (including detector), band-filter, 245 push-pull stage—these help make the 722 the outstanding buy of the year at \$74.75 net, completely wired, less tubes and cabinet. Component parts total \$52.90. Tubes required: 3—'24, 1—'27, 2—'45, 1—'80.

712 Tuner

Far more selective and sensitive even than the Sargent-Rayment 710, the new single-control 712 with band-filter and power detector stands far beyond competition regardless of price. Feeds perfectly into any audio amplifier. Tubes required: 3—'24, 1—'27. Price, only \$64.90, less tubes, in shielding cabinet. Component parts total \$40.90.

677 Amplifier

Superb push-pull amplification is here available for only \$58.50, less tubes. Ideal for the 712. Tubes required: 2—'45, 1—'27, 1—'80. Component parts total \$43.40.

735 Short-Wave Receiver

A screen-grid r. f. stage, new plug-in coils covering the bands from 17 to 204 meters, regenerative detector, a typical S-M audio amplifier, all help to make this first a. c. short-wave set first also in performance. Price wired complete with built-in power unit, less cabinet and tubes, only \$64.90. Component parts total \$44.90. Tubes required: 1—'24, 2—'27, 2—'45, 1—'80. Two extra coils, 131P and 131Q, cover the broadcast band at an extra cost of \$1.65. Adapted for battery use (735DC) price, \$44.80, less cabinet and tubes. Component parts total \$26.80. Tubes required: 1—'22, 4—'12A.

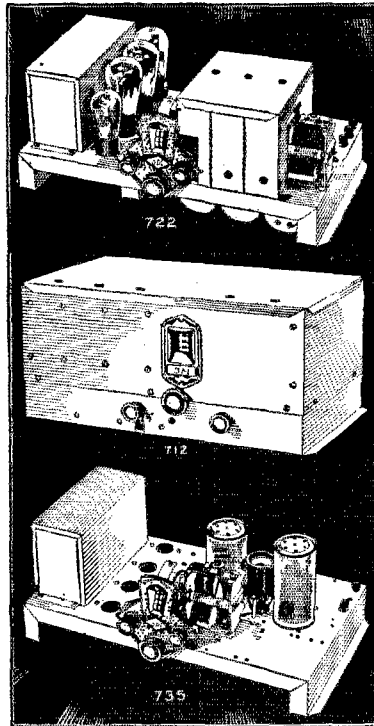

Keep up-to-date on Silver-Marshall progress; don't be without THE RADIOBUILDER. New products appear in it in advance of public announcements—all of the receivers and cabinets above were described in detail and illustrated in THE RADIOBUILDER for July. Many hints on operating and building appear in it. Use the coupon.

Custom-builders using S-M parts have profited tremendously through the Authorized S-M Service Station franchises. If you build professionally, let us tell you all about it—write at once.

SILVER-MARSHALL, Inc., 6409 WEST 65TH ST. CHICAGO, ILL. U. S. A.

Silver-Marshall Inc.
6409 West 65th St., Chicago, U. S. A.
.... Send your new fall catalog, with sample copy of the Radiobuilder.
.... For enclosed 10c, send five new selected Data Sheets, including those on 722, 712, and 735.
Name.....
Address.....



To obtain your radio operators' license—

SEE this book. It contains information essential for all men who are preparing to become licensed amateur and commercial radio operators. It contains hundreds of practical radio questions and answers.

Radio Operating Questions and Answers

By Arthur R. Nilson and J. L. Hornung

Second Edition

267 pages, 5 1/4 x 8, 91 illustrations \$2.00

This is the enlarged second edition of a book formerly published as *Radio Questions and Answers*. It covers the great advances which have been made since 1921 in the art of radio communication; it takes into account the new technic of broadcast-station operation which has been evolved through electrical, mechanical and physical improvements.

Chapters

- I. — Diagrams and Explanation of Complete Commercial Transmitter, Receiver, and Auxiliary Equipment.
- II. — Tube Transmitters.
- III. — Arc Transmitters.
- IV. — Spark Transmitters and Transmitters in General.
- V. — Receiving Apparatus and Radiocompass.
- VI. — Storage Batteries.
- VII. — Motors and Generators.
- VIII. — Radio Laws and Traffic Regulations.
- IX. — General and Theoretical Questions.
- X. — Broadcasting Transmitters.
- XI. — Amateur-Station Operation.

Fill out this coupon —

You will receive the new second edition for 10 days' FREE examination. It covers the latest laws and regulations governing radio operators and the operation of radio stations. ORDER NOW.

McGraw-Hill FREE EXAMINATION COUPON

McGraw-Hill Book Co., Inc.
370 Seventh Avenue
New York, N. Y.

You may send me Nilson and Hornung's Radio Operating Questions and Answers \$2.00 postpaid. I will either return the book, postage prepaid, in 10 days, or remit for it at that time.

Name

Street and No.

City

State

Name of Company

Official Position
(Books sent on approval in the U. S. and Canada only)
Q.S.T. 9-29

couragement, most of his class are now licensed operators. One of them is so pleased that a 40 per operator will hold a schedule with some 10 pers (and seem to like it) that he has been moved to write this letter. When a busy man will coach some distant strangers he has never met, with the patience and kindness exhibited by W6EAF, then this old world is not so hard-hearted as it is cracked up to be.

— C. Z. Walker, W6UGF

On Standard Frequency Signals

806 Walnut St.,
Edgewood, Pa.

Editor, *QST*:

The writer has noticed with regret the various communications appearing of late in *QST* commenting upon the failure of some American amateurs to stay within the assigned frequency bands. Particular regret is felt upon reading the complaints directed to amateurs who, in attempting to comply with rules for decent practice by calibrating their meters, have been seriously handicapped by the interference of heedless amateurs during the official broadcasting periods.

That this interference is caused by failure to realize the importance of cooperation, is strongly felt. The writer has known many amateurs over a lengthy period, and never yet has run across the type of amateur who was so constituted that he would not join hands if given the feeling that he was part of the plan and upon him there rested a certain responsibility for effecting the desired result. It is the same morale that prevails when an army private (with a rather dubious record of irresponsibility) is placed over a squad of men. The man's attitude changes. He realizes that he is part of the mechanism.

It is to be supposed that failure to coordinate perfectly with set rules for operating is to be encountered by reason of the youth and its attendant viewpoint which prevails in the amateur organization: a certain carelessness brought about by failure to realize the gravity of the situation facing the amateur today; and failure to understand the necessity of the most rigorous adherence to law and principles governing a democratic organization as our League is.

A series of articles in *QST* dealing with the subject of cooperation would seem to be the most effective means available to strengthen the appreciation of the fraternity as a whole toward air-tight team work in this respect. The older amateur has a background of sentiment toward amateur radio that new amateurs cannot be expected to have. These older chaps know the struggles the League has gone through, and appreciate the power of teamwork. They sense the position the amateur occupies in this period of radio unrest, competition, if you will, where only the worthwhile and the efficient can survive.

Acquaint the newer men with the precepts that obtain in our organization. Show how teamwork accomplished every worth-while thing in amateur radio's long list of achievement. And funda-

FOR THE NEW UX866
RECTIFIER TUBES THE
T3680 FILAMENT SUPPLY
TRANSFORMER IS AN
IDEAL UNIT

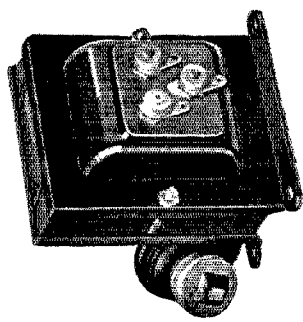

JUST WAIT 'TILL I
SHOOT MY SIGS OUT
IN THE AIR WITH MY
NEW THORDARSON
POWER SUPPLY.
I'LL MAKE 'EM
ALL SIT UP AN'
TAKE NOTICE.

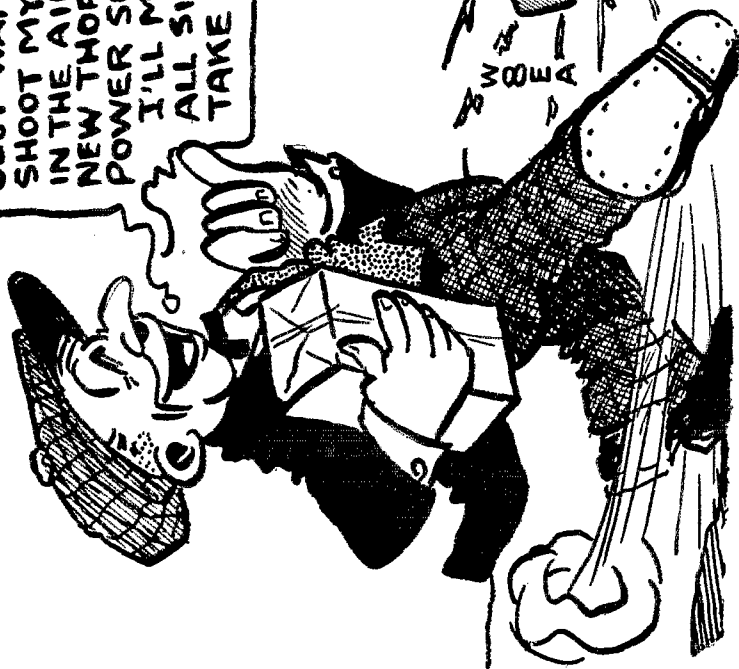

THORDARSON

ELECTRIC MFG. COMPANY
500 WEST HURON STREET
CORNER KINGSBURY
CHICAGO, ILL.

Cunningham RADIO TUBES

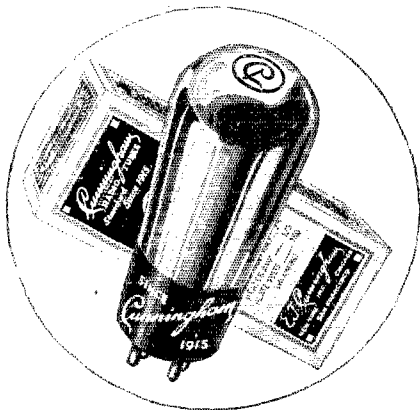

**Be Guided
by a name
that has meant absolute
tube integrity for the
past**

14 years

An ever increasing public demand has resulted in national endorsement based on fidelity of tone and superior performance.

They protect your radio investment.

E. T. CUNNINGHAM, INC.
New York Chicago San Francisco
Dallas Atlanta

mentally, bring home the knowledge that every American amateur has the responsibility placed in his hands of either building up, by earnest and cooperative effort, the good name of American amateur radio, or tearing it down by heedless, slipshod practices.

In an organization of our kind, where every man's activity is governed, for good or bad, by his own attitude, one indifferent man can adversely affect painstaking and law-abiding efforts on the parts of many men.

— J. C. Flippin, ea-W5YD

Facts About QSL Cards

Denver, Colo.

Editor, *QST*:

In reading the various comments from time to time regarding QSL conditions, I became curious to know what the log book of this station showed. The following may be of interest to others anxious to receive cards and who take pride in collecting them. Districts are listed on a percentage basis of cards received here verifying contacts and according to their standing at this station.

District	Cards Received
7th.....	52.08%
2nd.....	49.98%
1st.....	43.40%
3rd.....	38.05%
6th.....	37.48%
8th.....	33.88%
4th.....	31.35%
9th.....	30.40%
5th.....	25.28%

Ending December 31, 1928, and counting only first contacts, the total number of stations worked was 533 and the QSL receipts only 37.98%; 530 cards were mailed from this station, an average of 99.11%.

And believe me, fellows, the log book, so far, for 1929 looks much worse.

— R. J. Andrews, W9AAB, W9DNY

Calls Heard

(Continued from page 61)

w6gi w6ju w6kq w6pw w6ty w6abg w6ace w6acw w6adw
w6aga w6agx w6akw w6ame w6avj w6awa w6axe w6azy
w6bek w6ben w6bec w6bjx w6bnq w6boa w6bqa w6bqk
w6bsj w6bsk w6btq w6btz w6bwe w6bwi w6byb w6byy
w6bdz w6cet w6efz w6egq w6cha w6cht w6chv
w6cii w6cja w6ery w6erz w6eug w6euh w6eui w6euk
w6eut w6evv w6eww w6eyx w6eak w6ezo w6eaz w6dah
w6dbo w6der w6dfs w6dix w6dkv w6dpi w6dqy w6dsj
w6dtd w6dwy w6dyn w6dzz w6dzh w6dlz w6dzu w6dzy
w6dzy w6eau w6eao w6eba w6ebn w6ebv w6ebx w6eel
w6efr w6egk w6egr w6ehi w6ehm w6eib w6eiy w6ejt
w6emi w6eof w6eos w6eow w6epv w6eru w6eta w6eto
w6etn w6bb w6dd w6ek w6gl w6tx w6sr w6un w6wh
w6aat w6ajw w6aky w6aaz w6aw w6iq w6it w6mb w6qb
w6rb w6rl w6tk w6ul w6us w6ve w6wo w6wz w6xe w6yau
w6ads w6adu w6ajt w6ajy w6aky w6apn w6aub w6axz
w6bcu w6bek w6bec w6bhi w6bjo w6brh w6sbl w6bti
w6bts w6byb w6byn w6eau w6eed w6chg w6chp w6ckl
w6cmg w6cuh w6csu w6csw w6czm w6ddk w6def w6dko
w6dkt w6dlg w6dsy w6dxy w6fab w6ek w6fb w6fp w6fs
w6jl w6ka w6lk w6ml w6oo w6um w6aab w6ack w6aeq
w6afb w6ahq w6ajz w6akq w6alm w6ama w6anq w6aqr

JEWELL 199 SET ANALYZER

*A High Grade Instrument
Backed by a thorough Data Service*

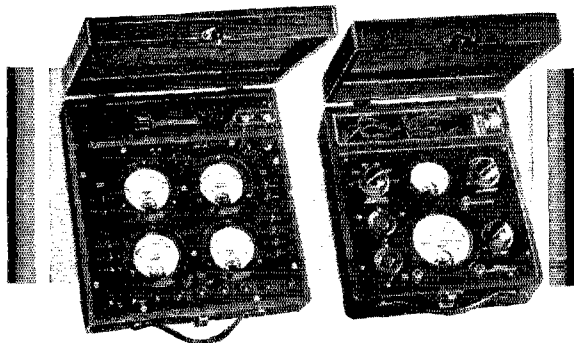
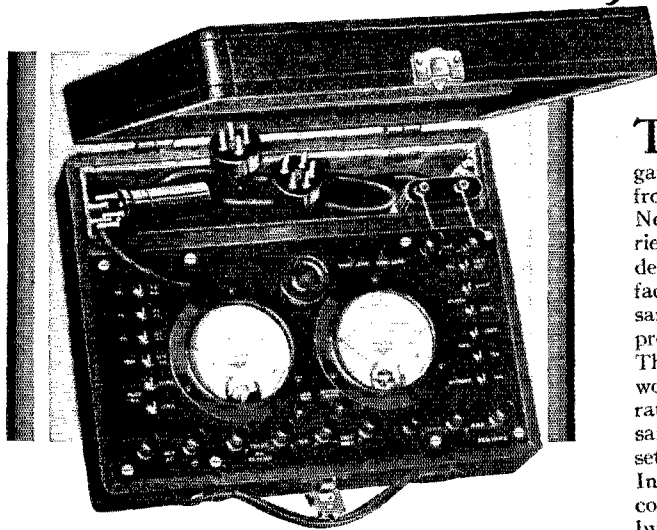

THE inherent accuracy and complete reliability of the Pattern 199 have gained for it the confidence of service men from coast to coast.

Nearly thirty years' manufacturing experience, combined with painstaking care in design, has perfected the large 3 3/4 inch face instruments used in the 199. Thousands of these instruments have been proved in exacting industrial applications. The Jewell 199 not only makes every worth while radio test, but does it accurately, stands up well in service, and at the same time is the lowest priced, high grade set analyzer on the market today.

In addition to the high quality and low cost of the Jewell Pattern 199, it is backed by the most thorough and complete data service available. Jewell "Instructions for Servicing Radio Receivers," furnished with every Pattern 199 Set Analyzer, contains checking data on sets of leading radio manufacturers.

Pattern 198 includes the 199 in a large case with compartments for replacement tubes and tools.

Mail the coupon for a free copy of the valuable booklet. "Instructions for Servicing Radio Receivers."



Jewell Electrical Instrument Co.
1650 Walnut Street, Chicago, Ill.

Please send us your booklet, "Instructions for Servicing Radio Receivers," and literature covering Jewell High Grade Radio Service Instruments.

Name.....

Address.....

Pattern 409, 4-Instrument Set Analyzer, designed especially for expert radio service men, gives plate voltage, plate current, filament, and grid voltages simultaneously. Same high quality throughout as Pattern 199.

Jewell Pattern 210 Tube Tester gives direct reading on all tubes from UVr99 to UX250, including half and full wave rectifier and screen grid tubes. Every dealer should have this valuable tube tester.

29 YEARS MAKING GOOD INSTRUMENTS

JEWELL

199 SET ANALYZER

Like a CAR with a balked Gas Lever —in heavy traffic

Your foot on the gas brings a jerky response . . . you're holding up traffic that's anxious to move.

Your variable resistance feeds the "gas" to your radio receiver . . . and there's all the difference in the world if its a CENTRALAB.

Quiet, even flow of current without a crackle or a sputter . . . that's CENTRALAB performance . . . a scientifically constructed precision resistance control for the modern radio receiver.

Central Radio Laboratories
20 Keefe Ave. Milwaukee, Wis.

w9aqw w9arf w9baz w9bez w9bcg w9bec w9bnd
w9bqc w9brc w9bat w9bvf w9bwt w9bfa w9bfn w9bpg
w9bpp w9berd w9besl w9besu w9beve w9bevn w9bexk w9beyw
w9bdbj w9bddv w9bdly w9bdnj w9bdph w9bdqc w9bdrw w9beht
w9bedd w9beezy w9belz w9bema w9beqc w9berb w9betd w9betq
w9bevj w9bevy w9bezr w9bedj w9bfgo w9bflh w9bfqn w9bfty
w9bgag w9bgal w9bgdh w9bgft w9bggp eljx ce2ab ce3bm
em2fc em2yb em3af hel1g hc1fr hc2jc k1bn k4ni k6cjs
k6ddq k6eqe k6ete kd5v kir5 kir6 lubh6 lutez mfnic
m7nie o4qg nr2wd ve4eb ve4gk vk2ac vk2hl vk2ho vk2ow
v54eg xau2 xcal xed1 xno9 xod4 zlat zllft zllfv zllma
zlb2c zlb2e zlb2f zlb2g zlb3s zlb3em zld4a zld4e 55x

*W9BGX, L. Weldy, 1345 Chestnut St., Bowling
Green, Ky.*

14,000-kilocycle band

ce1ah cx1ev ct1bx ce3ac em262 f8ep f8eo f8hod f8ypz
f8swa f8pm g6by g5by g6xb g2qy k6ac n12pa on4ft on4fp
py3ah py1em pasaw rx1r5 rxw xpa0ja xpa0zz

*Lawrence R. Mitchell, 117 S. Chestnut St.,
Kewanee, Illinois*

3500-3550-kilocycle phone band

w1aby w2bna w2xab w3ez w4oa w4zi w5aob w5kx w5axi
w8rd w8zb w8adf w8akh w8ajh w8rl w8ecz w8avw w8efy
w8yz w8rtj w8wo w8ddt w8bzz w8aou w8wm w8dxb
w8rw w8vpr w8ewu w8aof w8dhm w8zad w8tke w8ghx
w9btg w9epw w9aul w9awn w9dju w9dgp w9fju w9evu
w9ejh w9che w9eym w9dws w9eri w9fk w9eyz w9cbq
w9eoh

Doings at Headquarters

(Continued from page 31)

Atlanta was also one of the visitors. Mr. C. R. Myers of Chicago showed up to say "hello." Former 1KC of Northampton, Mass., well known when we started working foreign DX below 150 meters, dropped in to talk over old times.

"KB" and Bud spent two weeks in July at summer camp with the Connecticut National Guard observation squadron, the 43rd Division Aviation. They both seem to have enjoyed themselves.

The "gang" all attended a farewell banquet for Harold P. Westman, who severed his connections with this outfit to "carry on" with the I. R. E.

The Communications Department had a vacancy for a few days when L. R. Huber resigned to return to Iowa for a vacation and to resume his college career in the fall. Mr. E. L. Battley, W1UE of Wollaston, Mass., has joined us at Headquarters to fill this vacancy in the C. D.

Jim Lamb and Bev Dudley were not on the air much during July, as they were expending their energies on a "low-cost" phone transmitter. Results of this work are related elsewhere in this issue.

Congratulations are in order. Miss Julia Harwood is now sporting a diamond solitaire. "JH" is well known as the efficient young lady in the Secretary's office who spends her spare time forwarding stacks of QSL cards received from foreign countries to our members.

Rod has been getting up early mornings firing up the boiler under W1SZ and working "RAH" who is at present in Sydney, Australia, pounding brass from VK2JW.

F. E. ("Ned") Handy is busy devising bigger and better apparatus and signals for W1MK this fall.

SAFETY FIRST



have you a
**SPARE
Radio
TUBE?**

ARCTURUS
BLUE ^{A-C} LONG LIFE TUBES

are IMMUNE to
CURRENT CHANGES

ARCTURUS RADIO TUBE CO.
Newark, New Jersey

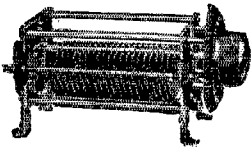

National Transmitting Condenser

We carry a complete line of parts made by "NATIONAL."

LEEDS

The Home of RADIO
45 VESEY STREET
NEW YORK

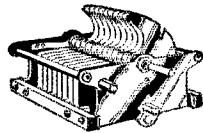

Cardwell condensers, double spaced for transmitting, .00025 cap. **\$4.45**

New York's Headquarters for
Transmitting Apparatus
When in Town Visit Our Store

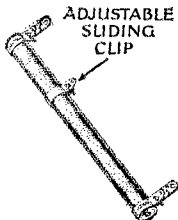

ELECTRAD Truvolt Wire

Fixed Resistances from 1 ohm to 100,000 ohms—can be tapped at any resistance.

We carry a complete line of Electrad products.

Make your own transmitting and receiving coils. Copper tubing transmitting inductance.

	Size of tubing		
Inside Dia.	3/16"	1/4"	5/16"
2 1/8"	9c	10c	12c*
2 3/8"	9c	10c	15c*
3 1/8"	10c	12c	17c*

Prices per turn

Ham Green, double silk covered, No. 16 receiving inductance.
2" diameter.....30c per inch
3" diameter.....35c per inch

Aluminum Shield cans and panels of every description to order.

Everything in Cardwell

Acme
Thordarson
Jewell
Flechtheim
Signal
Bradley
Tobe
Pyrex
Fleron

IN STOCK



We carry the largest stock of General Radio Parts in the country.

*Prices subject to change without notice.



NEON GLOW LAMPS

Made by General Electric Co., type G. 10, standard base. 101 uses, as illustrated in QST May issue page 17. Price only.....65c

\$7. THORDARSON R-195 TRANSFORMER

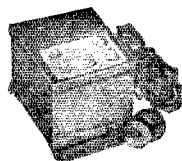

for B-Eliminator using the Raytheon B-H tube. Will carry the maximum current consumption without overheating. Low 235 volts either side of centre tap—high 285 volts either side of centre. Just 50 left, after that no more at any price.

\$2.25

By Insistent Demand

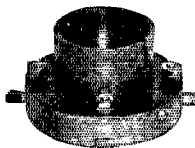

LEEDS 50-watt socket, positive contact; heavy phosphor bronze springs, heavy brass shell; will hold your tube in one position.

Special..... **\$2.50**

FEATURING

3 new items — Leeds Radio Lab. — others to follow in future issues. This department under the supervision of the Short Wave Specialist Jerome Gross. We design, construct and advise on any material for the "Ham" Broadcasting station or laboratory. Write Jerry Gross for advice on any of your problems.

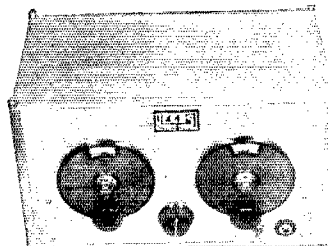

New LEEDS all aluminum plug in Short Wave Receiver. Coils not exposed, thereby insuring 100% shielded job. Short Wave — 3-tube Receiver — detector — 2 audio, using three 201-A tubes. Universal type, continuous range 15 to 100 meters; amateur type covers Ham bands 20-40-80 meters with generous spread on the dial.

List price \$60.
Special Offer, net..... **\$37.50***

New LEEDS 7 1/2-watt Hartley 1929 type Transmitter. Ideal for the beginner or anyone desiring a transmitter extremely simple to adjust and operate. Will operate with a 201-A tube, with 90 volts on the plate, up to a UX-210, with 30 watts input; has plug in transmitting coils. List price — \$55. Completely constructed \$70.

Special Offer, completely constructed..... **\$57.50***

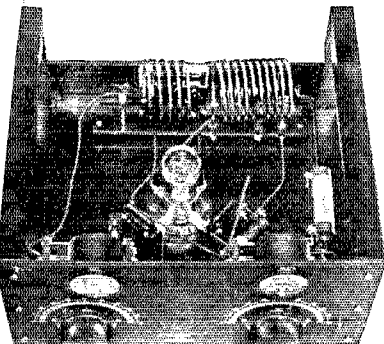

PLEASE PRINT YOUR NAME AND ADDRESS PLAINLY to AVOID DELAY

WRITE FOR SPECIAL PRICE LIST

MAIL ORDERS FILLED SAME DAY
10% Must Accompany All Orders

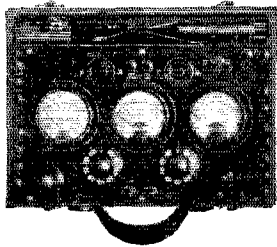

The New Radio Set Tester

THE radio industry is familiar with the Weston Model 537 Radio Set Tester — for A.C. and D.C. receivers. Service men hailed it with great acclaim a year ago, noting its many advantages over the Weston Model 519 — for D.C. only.

And NOW — here is another great advance — the Weston Model 547 — incorporating many additional features to meet the service testing requirements of radio's latest developments.

But with this NEW SET TESTER radio servicing is still further simplified, even taking into account the number of new tubes, sets and circuits.

Space won't permit description here — nor would words alone do this new set tester justice. You must see it for yourself — operate it — try to think up some service problem it can't solve. Try as you will the Model 547 will give you a quick and accurate answer every time. Convenient — complete — light and rugged. Handsome in appearance — and it will yield you handsome profits. It will increase your business and your prestige. **YOU CAN BANK ON IT!**

This instrument has many outstanding service features. But first of all it is a Weston — assuring you exquisite workmanship and complete service reliability. It is provided with three instruments — all $3\frac{1}{4}$ " diameter and furnished with bakelite cases. Carrying case, removable cover, panel and fittings are also made of sturdy bakelite.

WESTON ELECTRICAL
INSTRUMENT CORPORATION

602 Frelinghuysen Ave., Newark, N. J.

Weston

PIONEERS
SINCE 1888

INSTRUMENTS

Bob Parmenter was away during part of July on a vacation touring parts of these eastern states. "RP" is back now and full of pep for the coming months.

Dave Houghton has been smacking out some 275-yard drives on the golf links recently and is now in form to meet all comers.

Mr. Hebert has been active on the river lately, spending his spare time working on his motorboat and cranking his movie camera. (He is vice-commandore of the Hartford Yacht Club.)

The rest of the "gang" is engrossed in keeping cool and taking their kiddies to the circus when not carrying on with their duties here at Hq.

— C. C. R.

"XYL"

(Continued from page 24)

But it is not only the "thoughts" of our game; it is the friendships that intrigue us. Only we, who have sat in a fast-chilling room, listening with queer, hypnotic fascination to a friend, a mile, a thousand — or even ten thousand miles away, saying "73," can understand. We snap on our transmitter and out through the clear air go thin, etheric fingers; out through the infinite goes a handclasp of friendship. So we, sitting alone by our set, become suddenly warm and happy, for the Angel of Friendship has entered and we know that across the miles we have found a friend. Outside the pale stars gleam down on our invisible bond, a bond stronger than the strongest steel. Of such stuff are amateur friendships made.

Another question often asked me — do I build my own apparatus? I boss the job, generally, if that's what you mean, and at that I am QSA 5. Do I actually do the constructional work myself? Well, what do you expect from an "XYL"? "You can't teach an old dog new tricks," you know. When one enters a strange field of endeavor in the way I did, it takes a long, long time to catch up with even the worst of the lot. However, I feel that I am learning and getting better and, if I don't die too soon, may know something about it yet.

How does it fare with a woman in the ham game? I wish I were a man when it comes to that. The QSO's between the OM's are much more to my liking, since I do not seem to "fall" for what some of them say when they find a woman at the other end. It's not often any more that I tell them I am not one of the male of the species and have become quite used to answering to the titles of OM, OT, and OB, thank you.

Idiosyncrasies? And how! It is rather a delicate thing to discuss. It seems that no matter how bold or how bashful they are, a large percentage of the hams are budding Romeos over the air — or by mail. "88's" are the rule rather than the exception, but they are accepted in the ham spirit, as they are given.

There is no doubt in my mind that most hams, were it possible, would prefer to have a YL who could pound brass. The word pictures they paint

BARGAINS ARMY AND NAVY RADIO SURPLUS

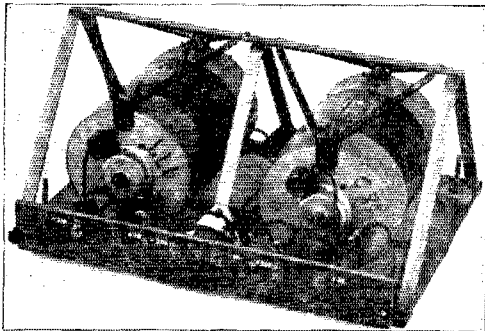

Western Electric Dynamotor System No. C.W. 927. Two 27,350 volt dynamotors in shock-proof hanger. May be used in parallel to give 100 mits at 350 volts, or in series, giving 80 mits at 700 volts. Can be used to operate transmitters up to 50 watts power from 32 volt D.C. mains. Ideal for Delco systems.
Two dynamotors in hanger..... \$25.00
Single dynamotor without hanger..... 15.00

Western Electric Switchboard C.W. 928. Control board for Dynamotor System C.W. 927. Consists of starting switches, fuses, 0-50-500 volt voltmeter with switches for testing main lines and output. Also contains complete filter system. Very special..... 8.00
Voltmeter, Westinghouse, No. 492419 cabinet portable, 2 scale 0-5-150, List \$6.50..... 2.50
Amp. hour meter, Souzamo, bat. charge and discharge, type MS 2 sizes, 0-300 and 0-500, List \$30.00..... 10.00
Voltmeter, Westinghouse, A.C. 8" dia. with external res. 0-175..... 12.50
Ammeter, Weston 425 thermocouple 0-2 amps. Complete on board with large double pole knife switch..... 7.50
Ammeter, Roller-Smith hot wire, 0-2 1/2..... 2.00
Dynamotor, General Electric Navy airplane, 24,1500 volts. Aluminum frame, unusually good for airplane test work, specially priced..... 32.50
Dynamotor, Sperry Gyro Co., 6/400 volt, 300 watt, ext. shaft..... 15.00
Motor Generator, Crocker Wheeler, 110 D.C., 200 A.C., 500 watt, 500 cycle. Ball bearing..... 50.00
Motors, Edison, universal, 50 watt, double shaft, 110 volt
Motors, Edison, D.C., 10 watt, double shaft (List \$10.50) 110 volt, 5000 R.P.M..... 2.00
Motors, Underwood, D.C., 75 watt, double shaft, 1200 R.P.M., 110 volt..... 3.00
Dynamotor armatures, Gen. Elec. triple commutators, two sizes, D.C. 12,750 volt and 24,1500 volt, complete with ball bearings (build field and save \$30) 10.00 and 12.50
Transformers, Peerless, 120 input, 5-10-15 volt output, 1/2 K.W., 60 cycle..... 7.50
Transformers, G. E. current type, 125 to 2500, with center tap, 60 cycle, 200 watt..... 7.50
Transformers, Amer. Tran., 220 to 8000, closed core, 1 K.W., 500 cycle..... 15.00
Transformers, Simon, 220 to 11500 closed core, 1/2 K.W., 500 cycle..... 5.00
Transformers, Amer. Tran., 220 to 12500 closed core, 1/2 K.W., 500 cycle..... 25.00
Gasoline Engine, 1 cylinder 2 cycle Smith 2 horsepower, complete..... 25.00
Gasoline Engine, 2 cylinder 2 cycle Sterling 5 horsepower, complete..... 50.00
Western Electric 219D Rectifier tube. Uses WE socket 119A. Filament 6 amps, 14 volts. Maximum plate voltage 1500 at 250 M.A. Specially priced..... 50.00
Condensers, Dubilier, mica, working volts 40,000, cap. (3) .002-.001-.0008..... 40.00

WANTED

RECEIVERS — IP-501, SE-1420, SE-143, CGR-1, SE-1220, CN-294,
DETECTORS, TUBE — SE-1071, SE-1071A.

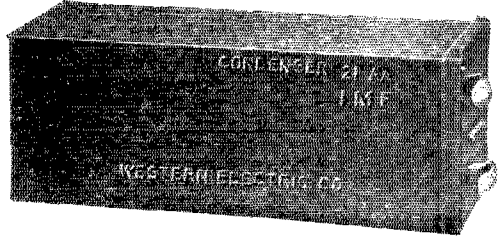

Western Electric Fixed Condenser 21AA, 1 microfarad, 1,000 volt A.C. test. Ideal filter condenser for low power transmitters. Fully guaranteed. Excellent value..... \$1.00

Condensers, Century, 500 volt, 4 mfd..... 1.25
Condensers, Dubilier, mica, working volts 12,000, cap. 0004..... 10.00
Condensers, Dubilier, mica, working volts 3,600, cap. .32..... 10.00
Condensers, Century, volts 500 A.C., cap. 4 mfd..... 1.25
Condensers, Wireless Specialty, copper leyden glass jar, 10000 working voltage .002 mfd..... 2.00
Condensers, Dubilier, mica, transmitting, 8500 working voltage .004 mfd..... 10.00
Condensers, Dubilier, mica, transmitting, 12500 working voltage .004 mfd. Prices on request.
Condensers, Wireless Specialty, transmitting, 12500 volt .004 mfd. Prices on request.
Keys, transmitting, Army practice..... 1.00
Keys, transmitting, Airplane flameproof, silver 1/4" contacts..... 1.50
Keys, transmitting, Airplane flameproof, silver, 3/8" contacts, with blinker light mounted on bakelite base. List \$7.00 — Special..... 2.00
Keys, transmitting, Navy 1/2 K.W., "Mesco" silver..... 2.00
Headphone, Army, with strap, 120 ohm..... .75
Headphone, Navy Radio School type, leather headband, 75 ohm..... 1.50
Transmitter, telephone, U. S. N., 30 ohm (used)..... .75
Radio-phone transmitter unit, Western Electric CW326..... 1.50
Magnets, Army mine and ringer type, has 4 large fixed magnets, good value..... 1.00
Variometers, Gen. Radio No. 107D and 107E, with series and parallel connections..... 5.00
Telegraph and buzzer portable sets, mahogany case, 2 tone platinum contact high freq. buzzer, 2 telephone toggle switches, potentiometer, sending key, 3 mfd. condensers, transformer and 2 choke coils, receiver, \$30 value..... 5.00
Heterodyne, Signal Corps, type B.C. 104. For use with SCR 97, 1000 to 3000 meters, with detector..... 15.00
Receivers, Signal Corp type, B.C. 14A, 200-600 meters, with cry. det. and Century buzzer in portable case..... 7.50
Receivers, Navy, C.N. 113, 300-2500 meters..... 15.00
Receivers, Signal Corps, 300-3000 meters, with built-in tube detector, portable..... 20.00
Receivers, Marcon, 300-2500 meters, type 106, commercial ship type..... 35.00
Receivers, Navy, C.N. 240, 1000-10000 meters..... 50.00
Receivers, S.E. 143 and I.P. 500. Prices on request.
Insulators, Electro, strain 7"-15, 12"-35, 18"..... .35
Switch, Telephone, toggle, 2-1-1-8 point..... .50
Western Electric Loudspeaker Unit 193 W. Ideal for monitoring your transmitter. Without cord..... 3.00
Coils, Retardation, West. Elec. Co. 57C, 83 ohm, 2 windings..... 1.00
Buzzers, Century high freq., 2 volts..... 1.50
Buzzers, West. Elec. extra quality high freq..... 1.50
Code practice sets, Navy type, 1/2 K.W. Bunnell brass key, Mesco high pitch buzzer, 75-ohm headphone, mounted on Bakelite base with 5 large binding posts, some with extra D.P.D.T. switches..... 4.50
Air compressors, Kellong, Model T, 1 1/2 cu. ft. per min., weight 6 lbs., 600 R.P.M., 125-lb. pressure..... 3.00
Milliammeter, Westinghouse, type C.A. 0-250, zero adjustment, flush mounting..... 5.00
Ammeter, Westinghouse, type C.A. 0-1, zero adjustment, flush mounting..... 5.00
Voltmeter, Westinghouse, type C.A. 0-35, zero adjustment, flush mounting..... 5.00
All above type C.A. meters operate on either A.C. or D.C. Regular price..... 10.00
D.C. Ammeter, Westinghouse type PX2, 0-5, regular price, \$10.00..... 5.00

Largest Radio and Electric Supply House in U. S. devoting eight floors to and specializing on Army and Navy Surplus. Due to rapidly moving stock and as new items are continually arriving we are unable to publish a catalog. Write us your particular requirements. Sufficient postage and deposit of 20% required on C.O.D. orders. NO C.O.D. ON CANADIAN ORDERS.

MANHATTAN ELECTRIC BARGAIN HOUSE, Dept. Q, 105-7 Fulton St., New York City

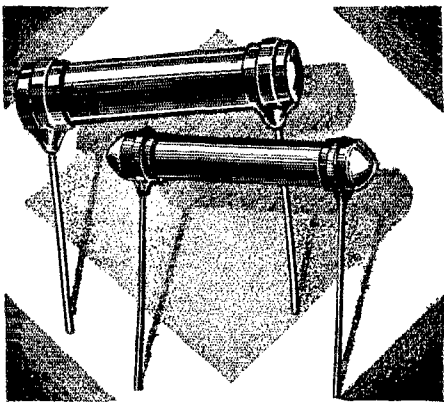

Quietness — Permanency Two Big Features of the Bradleyunit Resistor

THE outstanding noiseless performance of the Bradleyunit Resistor compared with other types of resistors is clearly revealed by laboratory tests. Quiet performance and permanence of resistance rating are highly essential qualifications for fixed resistors used in modern receivers of high amplification. Continued repeat orders from leading set manufacturers is ample proof that the Bradleyunit maintains its remarkable performance for the life of the set. It is unaffected by moisture, temperature and age. Use the Bradleyunit on your set for insurance against noise and distortion.

Standard Bradleyunits are furnished in ratings from 500 ohms to 10 megohms. Special ratings supplied on request. Units are equipped without leads or with leads up to six inches in length. Color coded for quick identification and checking purposes.

Write today, giving complete specifications, for data and prices.

ALLEN-BRADLEY CO.
277 Greenfield Ave., Milwaukee, Wis.

Allen-Bradley
PERFECT RADIO  RESISTORS.

of "ham heaven" always include this phase in some form or other — (to quote): "It sure would be wonderful to have a YL who doesn't mind the junk around the kitchen, who can wield a soldering iron, and take her turn at the key." May I add, with impunity, that it is not always the "YMs" who express themselves thusly? Perhaps they would rather be hit with a tube than a rolling pin.

Another common characteristic is their innate courtesy to YL operators, especially when it comes to giving reports on signals and fists! They seem to think they must spread the applesauce thickly and curry favor by giving "QSA 5 and your fist is sure vy FB, YL." Why, even some of the Aussies give me RS! But I'm not fooled by any of it. I understand how they feel, and divide by two or three.

Schedules and pictures seem to be another weakness. My schedules are all for traffic with perhaps an occasional rag-chew when the hooks are clear. Pictures? Well, "that's my weakness, too." Nothing delights more than a snap of a friend of the air, and in my scrap book you will find a veritable "rogue's gallery" which I prize highly. Many of them seem to feel that a card and photo of a YL operator (even though she be an "X") make, as one ham said, a "grand slam" on the wall of the shack.

Aside from these two classes of hams, namely, the businesslike, efficient, though always courteous and friendly operator and the budding Romeo type, there is the third. He is the fellow who seems to actually resent the entrance of women into his erstwhile exclusive realm of amateur radio. I first came upon this type when I took my examination. He came in late, and the room was full. He sat down beside me, gave me one look and then turning to the gang, said, "Look who's here! Well, Gang, the good old days are gone forever," in a thoroughly disgusted voice. Although his type is very much in the minority, the feeling exists among some men who, no doubt, are proverbial women haters anyway.

I do not want to be too harsh about these idiosyncrasies, as there are lots and lots of hams who do not indulge. Put them down as sane — or else married. Take that as you will. Also, a lot of them do not hear you when you do tell them and keep right on "OMing" you. Put that down as a punk fist, if you wish to. Again, I say, I do not want to be too harsh, and perhaps had best left most of the above unsaid, because I really do get a "kick" out of some of the things they say and write, enjoy them, and do not want to spoil my pleasure.

Have I regretted entering the game? Well, who hasn't at one time or another? I have often become disgusted at all the "rotten" things in radio, but who am I to contradict T.O.M. himself? On the whole, I've had much enjoyment from my set, and am glad and proud to be one of the gang and a member of the A.R.R.L. The ham game is a great old game, and the species "ham" is a great old genus, and I say — "Long may it, and they, flourish."

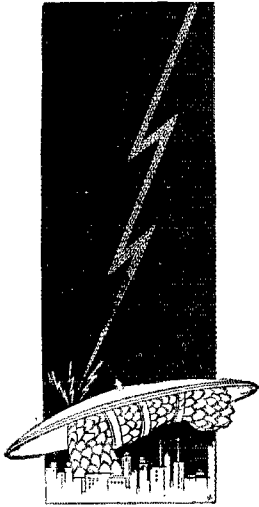

ALUMINUM FOR RADIO

*means
manufacturing economy
better reception
greater selectivity...*

IT is now a matter of proven record that Aluminum's workability, lightness, resistance to corrosion and high electrical conductivity make it the one metal that most efficiently meets the differing conditions encountered in radio design.

Used as shielding Aluminum reduces interference. It eliminates electrostatic and electro-magnetic interaction between the various stages of radio-frequency amplification. It eliminates modulation of radio frequency stages by feed back from audio-frequency amplifier. It is so easily worked into cans, boxes or casings that it presents few limitations of sizes and shapes, and makes possible more compact designs.

Used as variable condenser blades, Aluminum is available in special sheets of an accuracy and uniformity beyond anything previously developed for that purpose. Gauge tolerance in thickness is limited to $\pm .001$ inch, with a total

variation within one sheet never exceeding .0005 inch.

For fixed condensers Aluminum Foil is ideal, because of its high electrical conductivity and its great covering area. A pound of Aluminum Foil .0003 in thickness covers 34,000 square inches.

And Aluminum Die Castings combine lightness, strength and accuracy. They are used with great success for loud speaker frames and bases, condensers and condenser frames, drum dials, chassis and cabinets.

We solicit inquiries for Aluminum foil, sheet, wire, rod, tubing, stamping, die castings, sand castings, extruded shapes, screw machine products, wood grain panels, strong Aluminum alloys and magnesium products.

Aluminum Company of America
2439 Oliver Building Pittsburgh, Pa.
Offices in 19 Principal American Cities

ALUMINUM

The mark of quality in Radio

U.S. Government Commercial

RADIO Operator's License

**WE specialize in
training students for U. S.
Government license.**

30 licensed graduates in four months without a failure. One student made 99.7%.

All graduates placed and short-age now exists.

Learn under "old timers" with 20 and 25 years experience in radio. Ownership management insures success.

*Same faculty for
seven years*

Oldest, largest and best equipped Radio School in New England. — Est. 1905.

Radio Service Classes begin Sept. 10th

Send for Catalog

MASSACHUSETTS RADIO SCHOOL

18 Boylston Street
BOSTON, MASS.

Call W1YS—20-40-80 meters

R. F. Trop, Treas.

G. R. Entwistle, Pres.

**Choice of 1200
Newest
RADIO
VALUES**

SEND for our 1930 catalog. Filled with amazing values in screen grid radios, push pull audio, consoles, kits, parts. All standard makes and guaranteed merchandise.

FREE

WESTERN RADIO MFG. CO.
128 W. LAKE ST. CHICAGO ILL.

Election Notices

(Continued from page 24)

eligible candidates nominated for the position by League members residing in Canada, Newfoundland and Labrador.

3. Nominating petitions are hereby solicited. Ten or more A.R.R.L. members residing in the Dominion of Canada, Newfoundland or Labrador have the privilege of nominating any Canadian member of the League as a candidate for Canadian General Manager. The following form for nomination is suggested:

(Place and date)

*Executive Committee,
American Radio Relay League,
Hartford, Conn.*

Gentlemen:

We, the undersigned members of the A.R.R.L. residing in the Dominion of Canada, Newfoundland or Labrador, hereby nominate of as a candidate for A.R.R.L. Canadian General Manager for the 1930-1931 term.

(Signatures and addresses)

The signers must be League members in good standing. The nominee must be a Canadian member of the League in good standing, and must be without commercial radio connections. His complete name and address should be given. All such petitions must be filed at the headquarters office of the League in Hartford, Conn., by noon of the first day of November, 1929. There is no limit on the number of petitions that may be filed, but no member shall append his signature to more than one such petition.

4. Mr. A. H. Keith Russell, of Toronto, Ont., is the present Canadian General Manager.

5. This election is the constitutional opportunity for members to put the man of their choice in office as the Canadian member of the A.R.R.L. Board of Directors. Members are urged to take the initiative and file nominating petitions immediately.

For the Board of Directors:

K. B. WARNER, *Secretary.*
Hartford, Conn., 1 August 1929.

Utilizing the Standard Frequency Transmissions

(Continued from page 37)

of the same frequency as the incoming signal, and so on for each point.

The foregoing method is not very good, however, both because the point of resonance cannot be determined very precisely and because it will not occur each time at the same setting of the condenser of the meter unless the coil of the meter and the coil of the receiver are the same distance apart and in the same relative positions. It's really not a 1929 method at all. If the standard frequency signal is being received with a fair amount of volume, a much better method is to remove the meter somewhat farther from the coil of the receiver and then slowly vary the con-

THE AMATEUR'S BOOKSHELF

Readers of *QST* appreciate the need for good radio books. What we consider to be the best standard text books are handled by A. R. R. L. Headquarters for the convenience of members of the League and readers of *QST*. Those listed below pretty well cover the requirements of the average amateur or experimenter.

The Radio Amateur's Handbook , by F. E. Handy, Communications Manager, A.R.R.L., and R. A. Hull, Director, A.R.R.L. Technical Development Program. Fifth edition. Over 53,000 copies in use. A manual of amateur short-wave radio-telegraphic communication. The standard text book and manual for transmitting amateurs. Contains immense quantity of data and information valuable to experimenters and all interested in any phase of radio. Blue-and-gold Paper Cover. 232 pages, 188 illustrations	\$1.00
The Radio Amateur's Handbook , Cloth Bound Edition. Except for binding, identical with regular edition	2.00
Radio Simplified , by Kendell & Koehler, revised by J. M. Clayton	1.00
Radio Operating Questions and Answers , by Nilson & Hornung	2.00
Experimental Radio , by Prof. R. R. Ramsey. Third Edition. A splendid manual for the student and experimenter describing in detail 117 experiments of particular value and interest to the amateur desiring a complete understanding of radio work.	2.75
Elements of Radio Communication , by Ellery W. Stone	3.00
Practical Radio Telegraphy , by Nilson & Hornung. 380 pages, 223 illustrations. A text for prospective commercial radio operators	3.00
Radio Engineering Principles , by Lauer & Brown. An excellent general textbook	3.50
Radio Theory and Operating , by Loomis. A good text book for commercial and amateur radio operators	3.50
Manual of Radio Telegraphy and Telephony , by Commander (now Admiral) S. S. Robinson, U. S. N., published by the Naval Institute. "Ranks with the very best of all published radio matter. . . . Not only worth its cost but is perhaps the best radio book that ever came to this desk." — <i>QST</i> Book Review	4.00
Thermionic Vacuum Tube , by H. J. Van der Bijl	5.00
Radio Manual , by Geo. E. Sterling, edited by R. S. Kruse. For students, operators and inspectors	6.00
Principles of Radio Communication , by Prof. J. H. Morecroft. An elaborate general textbook. 935 pp., 5 $\frac{3}{4}$ x 9	7.50
Ideas for The Radio Experimenter's Laboratory , by M. B. Sleeper25

Prices include postage

Read 'em and learn!

AMERICAN RADIO RELAY LEAGUE, INC.

1711 Park Street

Hartford, Conn.

Something New



A Resistance Unit

that embodies an entirely new development in construction — the only doubly-insulated, moisture-proof, wire-wound, non-inductive accurate resistor. 8/32 screw terminals permit its instant use in any type of circuit in any convenient manner as well as in standard grid-leak mountings or fuse-clip mountings or by soldering.

The SUPER AKRA-OHM

besides containing all these unusual features has a very low temperature coefficient, a minimum distributed capacity. Made to dissipate one watt but will stand an overload without injury. Type 6-M has a tolerance of accuracy of approximately 1% plus or minus. Closer tolerances made on special order.

Complete stock of all values enable us to make immediate shipments. Full information and prices will be furnished promptly on request.

Shallerross Mfg. Company
ELECTRICAL SPECIALTIES
700 PARKER AVENUE
Collingdale, Pa.

Resistor
NON-INDUCTIVE
WIRE WOUND
RESISTOR

denser. This time only a slight shift in the beat note, between the incoming signal and the receiver, will be heard as the resonance point is passed. In this manner the exact point of resonance can be determined with much greater precision, and will always occur at the same setting until the floor rises up and hits the meter. This assumes that your meter has been well and substantially constructed.

If the standard frequency signal is not being received with fair volume, an auxiliary oscillator may be resorted to. Don't let the big words scare you into thinking they mean some high-hat and hard-to-construct laboratory apparatus. It's just another way of saying "an extra receiver." Tune in the standard frequency signal to zero beat or a low beat note. Next tune the auxiliary oscillator until its signal is heard in the receiver, and adjust to some convenient beat note. This time as the meter is varied a slight shift will be heard in the beat note of the oscillator with the receiver. If some incoming signals are loud enough to disturb the operator the antenna may be disconnected during this part of the work, provided the antenna coupling is loose enough so that this does not appreciably change the frequency of the receiver.

If the auxiliary oscillator be especially made for the purpose, it may be calibrated, and is then called an oscillating or heterodyne frequency meter. If properly constructed, it will hold its calibration much better than an ordinary receiver, and will be sufficiently accurate and much more convenient for the average traffic station. It need be calibrated and operated in but one band. If operating in the 3500-ke. band, its second harmonic will fall in the 7000-ke. band and will be readily heard in the receiver. The frequency of a distant station in the 7000-ke. band will be exactly twice the frequency indicated by the meter. For further description of the use of harmonics, see the article by Mr. Grammer above referred to.

The standard frequency stations have gone to the trouble of handing you just what you want, when you want it in such a way that your meter can be calibrated with the least amount of work, time, and trouble. But though this reduces your work to a minimum it does the exact opposite for the transmitting station. The transmission of these frequencies at the high degree of accuracy maintained is a real job, not the sinecure it is generally assumed to be. Even the matter of making sure that each transmission is sent when scheduled regardless of colds, headaches, heartaches, YLs, OWs, or what have you, is something that very few stations can accomplish with regularity.

The only "remuneration" these stations receive is the written thanks their operators receive from those who use their work. These stations, at least in regard to standard frequency work, are engaged in rendering a service, not a DX contest, and the written thanks of the man in the same state are as much appreciated as those of the man many thousands of miles away. Such letters

Wholesale Prices

for Dealers, Agents and Set Builders—prompt deliveries



OUR huge Wholesale Radio catalog No. 19 (2ND EDITION) is a valuable encyclopedia — a liberal Radio education. Mailed immediately on request—absolutely

FREE

1500 Illustrations and
6000 articles

FROM many years in the Radio Mail Order Business, we have learned how an organization must be efficiently run to gain and retain the good will of our customers. Radio Specialty Co. ships orders promptly! — offers you 100% quality merchandise on a strict money-back basis if not thoroughly satisfied — and sells at rock-bottom net prices.

Our catalog contains the largest assortment of completely assembled all-electric AC Receivers at amazingly low prices, and other Radio Merchandise including such lines as Pilot-Silver-Marshall — Carter-Aero — Yaxley — Tobe — Hammarlund — Amer-Tran — Cunningham — Dongan — Thordarson — Muter, etc., etc. The latest improvements in Radio are listed and thoroughly described in this great catalog: AC All Electric Sets with self-contained ABC power supply — Public Address Amplifier systems — A.C. Set Converters — A and B eliminators — Dynamic Speakers and Units — Magnetic Speaker Chasses — 235 and 250 Tube Amplifiers — Airplane Cloth Speakers — Push-Pull Power Amplifiers — Electric Phonograph Turn-Tables — Combination Radio and Electric Phonograph Consoles — Speaker Tables — Short Wave Sets and Adapters — Shield Grid Tube Kits — Television Parts — Electric Household Appliances, Tools, Workshops — CAMERAS — etc.

Send for Catalog No. 19 (2ND EDITION) today

Radio Specialty Co. 100S Park Place
New York Radio's Oldest Mail Order House

HAMS KNOW



THIS FROM A HAM IN TEXAS—

Los Fresnos, Tex.
6-24-29

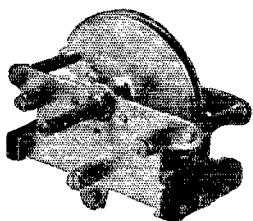

*Taper plate 191-E
Ideal for short wave receivers*

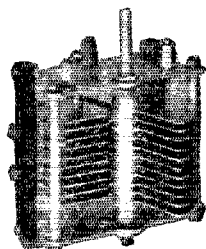

*Transmitting type 164-B
Capacity—.00022 mmfd.*

Sirs:

I am contemplating upon building a good Amateur Transmitter in the very near future and would appreciate a catalogue from you. When it comes to condensers for transmitting, I can think of nothing better than Cardwells.

Any pointers or late ideas in Amateur Transmitters would be appreciated.

Very truly yours,
J. A. B., Jr.



IT IS refreshing these days to see untainted testimonials. A product that lives up to its promises for superlative performance will always have enthusiastic endorsers. Cardwell has never suffered from a lack of them.



RECEIVING Condensers in all standard capacities. **Transmitting** Condensers for powers up to 50 K.W.-Fixed (Airdielectric) transmitting condensers. Literature will be promptly sent on request.

CARDWELL CONDENSERS

Allen D. Cardwell Mfg. Corp.
81 PROSPECT STREET
Brooklyn, N. Y.

IF YOUR DEALER DOES NOT
STOCK ÷ ÷ ORDER DIRECT

ACME WIRE PRODUCTS

Coils — Magnet Wire Wound
Magnet Wire All Insulations
Varnished Insulations
Parvot Filter and By Pass Condensers

All products made to Recognized Commercial Standards including those of:

National Electric Mfrs. Assn.
Radio Manufacturers Assn.
American Society for Testing Materials

For 25 years manufacturers and suppliers to the largest and most discriminating users.

THE ACME WIRE CO.
NEW HAVEN, CONN.

Branch Offices:

New York Cleveland
52 Vanderbilt Ave. Guardian Bldg.
Chicago
842 N. Michigan Ave.

should be addressed to Experimenters' Section, A.R.R.L., 1711 Park Street, Hartford, Conn., where their data are recorded in connection with wave-propagation problems and then forwarded to the station concerned. Not more than one station should be reported on the same page or card. For those who will report with some degree of regularity, the Section will furnish mimeographed reporting blanks upon request.

Above all, fellows, show your appreciation to the stations if you wish these services continued.

The writer is always glad to receive criticisms or suggestions for the improvement of these services, provided they are not of such nature as would materially increase the work of the transmitting stations.

The A.R.R.L. Official Frequency System

(Continued from page 38)

announced for the benefit of those able to use such accuracy, but for all general amateur purposes the frequency of transmission of both stations may be assumed equal to the figures as herein given. While no responsibility, financial or otherwise, is assumed for the accuracy of these transmissions, every effort will be made to have it exceed the figure given.

Reports on Standard Frequency Transmissions are solicited from all who take advantage of this service. No matter how far from or how near to the transmitting station you may be, your report will be of value to us. Standard blanks which will facilitate your filling out and our handling of the reports are available on request. All such requests and reports should be addressed to: Experimenters' Section, American Radio Relay League, 1711 Park St., Hartford, Conn.

After your report has been checked and acknowledged, it will be forwarded to the Standard Frequency Station upon whose signals it comments.

OFFICIAL FREQUENCY STATIONS

(Required accuracy 3-10 of 1%)

W1AAC, W1AVW-W1ZL, W1AWW,
W1AXA, W1BD, W1BZQ, W1CCW, W1CK,
W2BO, W2CDC, W2CLA, W2DS, W2EF,
W2MU, W2UV, W4BY, W4LK, W5EW, W5OX,
W5SP, W5ZAV, W6AKW, W6AM, W6AYC,
W6AVJ, W6BB, W6BGM-W6CVO, W6BMW,
W6BRO, W6BZU, W6CAE, W6CDY-W6CPX,
W6CMP, W6EC-W6XE, W6QL, W6QX,
W6WN, W6ZV, W7AAT, W7GQ, W8APZ,
W8BAV, W8BZT W8EQ, W8GZ-W8ZG,
W9AHQ, W9ACG, W9BGH, W8BGK, W9BVC,
W9CPM, W9EFO, W9EGU, W9IG, G2PD,
G2NM, G5BY, G5YK, G15NJ, VE2BE,
VE3CO, VE3FC, VE4BT, VK5BG, VK5LF,
VK7CW and ZL2AC.

STANDARD FREQUENCY TRANSMISSIONS OF WWV

Schedules of standard frequency transmissions from WWV, The Bureau of Standards, Wash-



Takes Out the Hum In Any Dynamic

IN spite of the many methods utilized to eliminate the hum in A. C. dynamic speakers, many of the best dynamics still have a hum which is sufficiently pronounced to be objectionable.

You will be surprised at the completeness with which an Aerovox 1500 mfd. "A" condenser, connected across the field coil or across the rectifier output will eliminate the hum and increase the sensitivity of the speaker.

Complete details and comparative data showing the results of using an "A" condenser to eliminate hum will be furnished on request.

A complete catalog of all Aerovox condensers and resistors will be sent free on request.



ASTOUNDING RADIO VALUES



LIST \$10.00

P. T. 537 FILAMENT RHEOSTATS

Rated to carry 15 amps.

An absolute necessity for the control of U.V. 203, 203A, 204, 204A and U.V. 851 Transmitting Tubes and 217, 217A, 217C and U.V. 1651 Rectifying Tubes.

Special \$3.75

PORCELAIN LOW-LOSS SOCKETS

MODEL U.R. 542

For use with U.X. 866, 852, 865, 860, 245, 210 and 250 tubes

On account of its low specific inductive capacity and its high insulating qualities, these Sockets are excellent for Short Wave work and especially adapted to the above tubes.

Special 50c

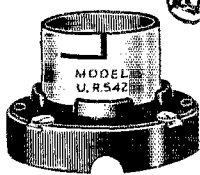

LIST \$1.00

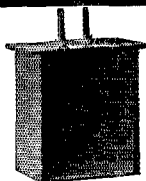

Designed to carry 250 mills

2 HENRY FILTER REACTORS

D. C. Resistance 20 ohms

Fine for use as Generator Filter, also as plate or Grid, Reactor, List Price \$10.00

Special \$3.50

Manufactured by the world's largest electrical concern whose name we cannot mention.....

LIST \$25.00

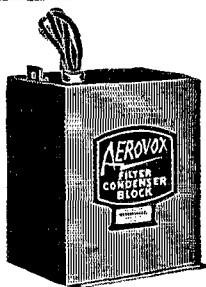

SIZE 6" x 5" x 3 1/2"

AEROVOX OR Dubilier HIGH VOLTAGE FILTER CONDENSER BLOCKS

Finest non-inductive High Voltage Filter Block ever made. Designed for use with UX-250 Power Tubes but can be used safely in filter circuits of transmitters or high power Amplifiers in any combination of capacities desired.

Each Unit is equipped with long, heavy, flexible leads, convenient for easy wiring, and also has mounting brackets.

The insulation resistance of these Condenser Blocks is in excess of R.M.A. and N.E.M.A. standard requirements.

Due to the request of manufacturers of these Condenser Blocks we cannot divulge the high list price of same.

All brand new, never been used, latest design.

SPECIAL

\$3.25

PER BLOCK

RATED D. C.	
CAPACITY	WORKING VOLTAGE
2.0 MFD.	1000 V
1.0 " "	800 V
3.0 " "	400 V

KOLSTER K5 DYNAMIC REPRODUCER IN WALNUT CABINET WITH BUILT-IN 210 POWER AMPLIFIER. LIST \$175

SPECIAL \$49.50

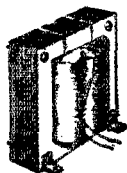

50 HENRIES FILTER CHOKES

85 MILLS

These are very efficient Chokes for use in Filter Circuits for your Transmitter, A and B. Eliminators or Power Packs.

The Choke Coils are very well constructed and are made with air gaps to prevent magnetic saturation from direct current.

SPECIAL \$1.50

LAST MINUTE SPECIALS

R.C.A. Uni-Rectron Power Amplifiers — Model A. P. 935 List \$88.50 ea.	SPECIAL \$19.75 ea.
E210 BRADLEYSTATS, list \$4.00, fine for A.C. Line Voltage Control	1.60 "
Kolster K 5 Dynamic Reproducers. List \$175	49.50 "
U. S. ARMY Aeroplane Spark Transmitters, Gov. cost \$47 ea.	4.75 "
G. E. Kenotron Rectifying Tubes (Type T.B.1)	1.25 "
Gould Kathode Unipower, Automatic Radio "A" Power (6 volt), list \$39.50	13.75 "
G. E. V.P. 14 — 5 watt Transmitting Tubes (A good power amplifying tube)	1.50 "
Eby A. C. Adapter Harness with volume control for 6 tube sets. List \$10.00	3.75 "
Kolster 135 Volt "B" Eliminators, List \$39.50 (without UX213 or 280 tube)	10.50 "

AMERICAN SALES CO., 19-21 Warren Street, New York City

Start the Radio Season with a Real Power Amplifier

Power Parts by Dongan

Designed especially for UX 245 Tube the following Parts will build you the very latest and finest kind of Power Amplifier — the type used with the new high-priced receivers.

No. 994 Power Amplifier Transformer either No. 2189 Push Pull Output Transformer	\$12.00
with No. 2142 Push Pull Input Transformer	\$4.50
or No. 3107 Straight Output Trans- former	\$12.00
with No. 2158 Audio Transformer	\$4.50
D-946 Standard Condenser Unit	\$22.50
No. 5554 Double Choke (use in Filter Circuit)	\$11.00
No. 2124 Transformer (for Push Pull Radio and Phonograph Amp)	\$6.00

Get complete information on the new and approved types of Power Amplifiers using UX 245 and UX 250 Tubes and Dongan Approved Parts. For immediate delivery of any of these parts send check or money order.

Dongan Electric Manufacturing Co.
2999-3001 Franklin St., Detroit, Mich.

It's EASY to Get a HANDBOOK

DIRECTIONS:

Realizing that Handbook must be had, proceed as follows:

- (1) Fill out below, tear off.
- (2) Reach in pocket, produce U. S. A. \$1 bill, old or new size (we don't care).
- (3) Clip together, mail us.

Handbook Factory,
1711 Park, Hartford.

SEND IT AT ONCE.

(Name)

(Street or P. O. Box)

(City and State)

ington, D. C., will be found on page 19 of the August issue of QST.

— J. J. L.

W9CJC

(Continued from page 35)

time to form an unbiased opinion without taking someone else's word for facts.

Little traffic is handled, although a message is never turned down, and if a message is accepted, it is either delivered or relayed. Rag chewing and experimentation are the main interests of Mr. Carter, who resorts to keeping schedules or handling a small amount of traffic when this becomes tiresome, or when the finances become low. This variety of interests makes an experienced amateur, and permits the formation of friendships in several phases of the amateur game that is bound to be of value.

Improving the All-Purpose Super-Heterodyne

(Continued from page 28)

Doubling the pick-up turns at 14,000 kc., for instance, confuses tuning only slightly, and the proper number of pick-up turns wipes out interlocking for all practical purposes. But since extremely critical adjustment is not necessary, the tedious part of the work is cut to a negligible point. Three turns too much of L_3 on OD, for another example, did not wipe out true resonance, leave alone making it undiscoverable, although it made the detector setting appreciably critical. An extremely important point is that one can use just sufficient pick-up to reduce interlocking without compromising sensitivity because pick-up is ample or in excess at the point where interlocking has practically ceased. Adjusting the

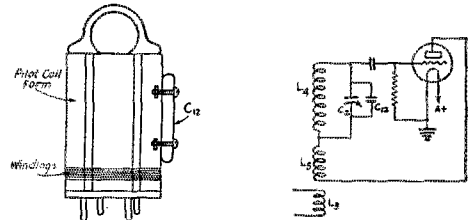

FIG. 7 — CONSTRUCTION AND CONNECTIONS OF THE SPECIAL OSCILLATOR COILS OJ AND OK. C_1 — 200- μ f.d., Sanyamo fixed condenser for OJ, 250- μ f.d. for OK.

pick-up to the quarter turn is not necessary, although those who like such fine cutting may imagine a gain by such care. Finally, instead of excessive interlocking appearing as soon as the frequency was raised above 2000 kc., it did not appear until above 7000 kc., and from there up to 16,000 the limit of my trials could be reduced to practical non-existence without the inefficiency of a loss in sensitivity.

OTHER RECOMMENDATIONS

Notice Fig. 6a. This shows the original order of circuit units within the set. 6b shows the recom-

Synchronous Motors for Television

In addition to building reliable and satisfactory motor generators, "Esco" has had many years of experience in building *electric motors* for a great variety of applications.

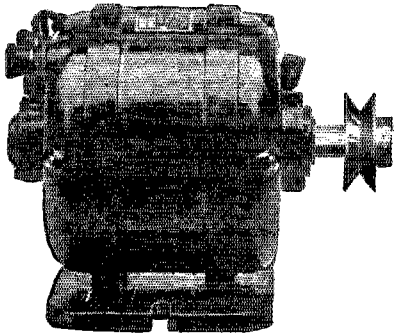

Synchronous motors, small, compact, reliable self starting are now offered for *Television* equipment. They require no direct current for excitation, are quiet running and fully guaranteed.

Other types of motors suitable for Television may also be supplied.

Write us about your requirements.

ELECTRIC SPECIALTY CO.

25 South St.

Trade "ESCO" Mark

Stamford, Conn.

Oscillating Quartz Crystals

Increased Production Methods allow us to announce new prices effective immediately on our guaranteed crystals—easy oscillators that are built for **Power Work**.

We grind these crystals to your approximate frequency, the frequency of each crystal stated accurately to within one tenth of one percent.

1715-2000 Kilocycle band.....	\$12.50
3500-4000 Kilocycle band.....	17.50
One-inch oscillating blanks.....	5.00

We are in position to supply power crystals for broadcast and commercial station work complying with the necessary requirements of frequency precision as demanded by Governmental regulations. Prices will be sent on request.

American Piezo Supply Company
1101 Huron Building Kansas City, Kansas
WLBF.....W9BKO

QUARTZ OSCILLATING CRYSTALS

Scientifically Prepared for Maximum Power and Unconditionally Guaranteed
1 in. square sections of your approximate specified frequency, supplied at the following prices:

75-100 meters.....	\$12.50
100-200 meters.....	10.00
200-600 meters.....	15.00
1 in. Tested blanks, 200-400, 400-600 meters.....	5.00
Dustproof Bakelite mounts.....	3.00

Sections of any practicable dimensions made to order
Prompt Delivery

J. T. Rooney, B. Sc., 4 Calumet Bldg., Buffalo, New York
"Twelve years' crystallographic experience"

BROADCAST MICROPHONE

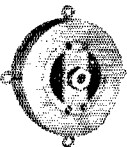

Finest broadcast microphone made. Double button. Stretched diaphragm type. Covers entire frequency range. Write for circular.

\$50

Broadcasters Service Bureau
San Jose California

THE RADIO BOOK

that has been endorsed and is in constant use by United States Gov't and over 300 Universities, Schools and Technical Colleges in this and foreign countries.

"Radio Theory and Operating"

By **Mary Texanna Loomis**

President, Loomis Radio College
Member Institute of Radio Engineers

Fourth Edition revised and enlarged to 992 pages, 800 illustrations and right up to date. Flexible Kraft Leather binding.

Price \$3.50 — Postage Paid

For sale by bookdealers throughout U. S. and many foreign countries, or may be purchased direct from the publishers. Send check or money order to

LOOMIS PUBLISHING COMPANY

Dept. 5

Washington, D. C.



The New and Better WIRE-WOUND GRID LEAK For Transmitters

UNIQUE construction allows for use of more wire of larger diameter than in other types of wire-wound resistors. Monel metal contact bands and soldering lugs provide equal expansion and positive connections. Guaranteed not to develop noise or open circuits. Made in three sizes (100, 40 and 15 watts) and ten resistance values, tapped for all usual needs, \$1.50 to \$5.50 each. Mail coupon for details.

ELECTRAD INC.

ELECTRAD, INC.,
Dept. Q9, 175 Varick St., New York, N. Y.
Please send details on your new WIRE-
WOUND GRID LEAK for transmitters.

Name Address

wended order, recommended because this permits the leads to L_3 to be properly short, an important point since they are alive with signal, oscillator and intermediate frequencies.

Stick to the shielding described in March *QST*. While I say this I have to admit that I have yet to build one of these sets in which the oscillator shielding was necessary when the oscillator wiring was short and direct, the by-passing and r.f. choke O.K. and the detector and oscillator coils separated by three inches. This is true even at 14,000 kc.

In those sets constructed with two audio stages, when the second detector approaches or is in oscillation, the second detector r.f. choke always proved dissatisfactory unless a Hammarlund 85 m.h. unit was employed.

Notes on Ethereal Adornments

(Continued from page 22)

taken in erecting and operating a single-feed Hertz antenna:

1. Choose the frequency on which you desire to operate.

2. Construct the antenna by following either the two formulas given above or the graphs. If you are more meticulous you may follow the entire procedure outlined.

3. Tune the transmitter to the fundamental (the chosen frequency) by means of an accurate frequency meter. Leave it there. A Hertz must be operated as near the fundamental or a harmonic as possible to secure high efficiency. Operating away from the fundamental or harmonic throws the whole system off.

Always remember the station is no better than the operator or the emitted signal, so before you tell us how rotten the antenna is, take the other factors into account.

I.A.R.U. News

(Continued from page 59)

is still growing rapidly, and has received several compliments from Dutch officials due to its good organization. Our official booth at the exhibition also brought us into close contact with several high Dutch officials, who were quite astonished to find such a perfect organization where they had always supposed there was only a disorderly group of ether-pirates. Our stand was visited by H. R. H. the Prince, by several ministers, our future radio inspector, Mr. G. Emmerik, and several other officials.

Now for a short description of the exhibit:

First, we had a complete station, the first licensed amateur station in Holland, working under the call PAOAA and built and operated entirely by our members. The booth and transmitter are shown herewith. Although they may not be clearly discernible, there are included, from left to right, an electric pick-up, modulator,

DODGE RADIO SHORTKUT

Masters Code—Kills Hesitation
Increases Speed—Produces Results

500 USERS CONFIRM STATEMENT
FEW REPORTS FROM FANS

- W9CTY W9CSU states:—Letters quoted July *QST* written by neighbor using my stationery and name. Please do not repeat.
3 hours with DRS could read code as print
Quickly fixed sigs in mind and stay put
Spare time work one week mastered code
Code impossible except with your method
DRS made code memorizing simple and easy
Four hours, spare time work, to qualify
Easy to learn code your way and does stick
Scratch to license in spare time 2 weeks
For memorizing code DRS best thing seen
One hour's study DRS secured my license
Mastered code in spare time one week
One hour on code and soon had license
DRS for quick results — Licensed in week
Until tried DRS thought knew the code
in 20 minutes had code set — soon licensed
in four hours came up from 4 to 12 per
Long struck at 5 — in 2 evenings copied 18
Long struck at 5 — in 2 weeks copied 15
Four sessions few minutes each on code
Old way waste of time—Code put in 2 hours
Mastered code in 2 hours. DRS is all OK
Stuck at 8 — first evening did 12 — now 25
Failed on Sig Maker — made grade with DRS
Hour on code. Passed easily in 2 weeks
Old way 3 months 5 per — DRS week 15 per
Long struck at 5. Qualified in one hour
Mastered code in 30 minutes: soon licensed
- WIBEH
W1BUC
W1US
W2AXO
W2BC
W2BXY
W3BPR
W3RY
W4BR
W5AVO
W5SP
W6AVH
K6BOJ
W6DGG
W6GLM
W7AAD
W7AHI
W7EI
W8AKJ
W8BLJ
W8RKB
W8CJK
W8CTV
W8SM
W8WGL
W8BWW
W9DLJ

WANTED — REPORTS FROM DRS USERS

DODGE HIGH SPEED

THE Booster — Comet Op: speed 27 raised to 42 in 4 weeks — few min. practice each evening.
Radio Shortkut \$3.50, High Speed \$2.50. Money Order. Foreign Add 50 Cents. C.O.D. if send One Dollar.

C. K. DODGE

Box 100 Mamaroneck, New York

For Short-Wave Phone Reception

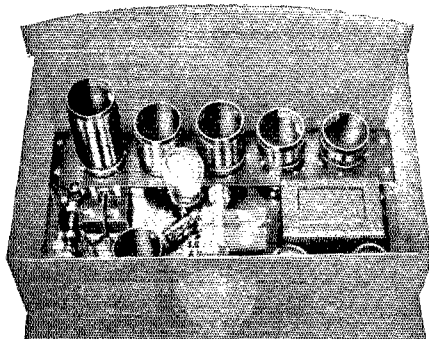

Write for information
and prices today.

A new NATIONAL Screen-Grid Thrill Box, the Screen-Grid SW-4 THRILL BOX, has been especially designed for reception of phone as well as code. The special audio system, with a high- μ tube in the first stage and a 171-A Power Tube, gives excellent loud-speaker performance. Code comes in just as well.

A Screen Grid R.F. tube eliminates "tuning holes" and prevents annoying radiation. Design gives steady reception with swinging antenna, adapting the THRILL BOX to use on motorboats and yachts. Operates on batteries or takes plate supply when desired from lighting circuit, through NATIONAL Velvet-B. Tuning and sensitivity control unusually constant and smooth throughout range of 15-300 meters.

Provided with dignified and attractive steel cabinet that harmonizes with any surroundings. Made by the makers of the NATIONAL Velvet Vernier Dials, used by Amateurs the world over.

NATIONAL

4 Tube Screen-Grid THRILL BOX SW-4

NATIONAL CO. INC., Malden, Mass.

Est.  1914

P A C E N T

Duo Lateral COILS

The complete line of all standard turn ratios preferred by leading laboratories and engineers.

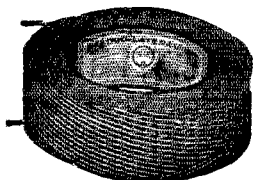

Write for information
and prices

PACENT ELECTRIC CO., Inc.
91-7th Avenue New York City

50,000 HAMS CAN'T BE WRONG!

Fall is coming. Send \$1 to-day for your copy of the 5th edition of the Handbook and be all set for your rebuilding problems.

SPECIAL TO AMATEURS

Barawik's new shortwavedept. has everything that amateurs desire. The Barawik Radio Guide gives full details. Send for it.

FREE RADIO GUIDE

SEND FOR IT!

Shows the latest wrinkles, newest developments in radio at startlingly low prices. Get the set you want here and save up to 50%. The best in parts, kits, complete factory-built sets and supplies. Orders filled same day received. Write for free 264-page copy NOW. Wholesale prices to net builders, dealers, agents.
BARAWIK CO. 119 Canal Sta., CHICAGO, U. S. A.



National Products Rectobulb

RELIABLE and efficient rectifier tube — low impedance due to mercury vapor — long life due to low temperature filament and oxide coated cathode of large area — of sturdy design which defies the rough handling incident to shipping them.

Normal Rating.....	250 Mils
Normal Plate Volts.....	3000
Filament Amps.....	1.7
Filament Volts.....	10

The accepted standard for Ham Work—of increasing appeal to the Engineer in small Fone Transmitters as used in Patrol Work and Air Service—Ideal for Small Broadcasters.

Send postpaid if cash with order — Safe delivery anywhere in U. S. A. GUARANTEED

Price, \$10 each

Announcing repair of UX852.....	\$16.50
We repair 203A tubes.....	\$19.00
204A tubes.....	\$75.00
WE 211 tubes.....	\$16.50
WE 212 tubes.....	\$40.00

ALL REPAIRS FULLY GUARANTEED

Chicago Radio Apparatus Co., North Central Agents

National Radio Tube Co.
3420 18th Street San Francisco, Calif.

Type 866 Rectifier Tubes

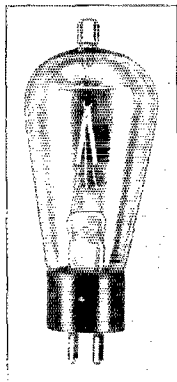

CHARACTERISTICS

<i>Mercury Vapor</i>	
<i>Voltage Drop</i>	15
<i>Fil. Volts</i>	2.5
<i>Fil. Amps.</i>	5.0
<i>Peak Inverse Volts</i>	5000
<i>Peak Plate Amps.</i>	0.6
<i>Total Height</i>	6 1/2"
<i>Diameter</i>	2 3/8"

LIFE GUARANTEED

\$8.00 Money Order

EDWIN C. EWING, JR.

Room 930, 29 S. LaSalle St.
Chicago, Illinois

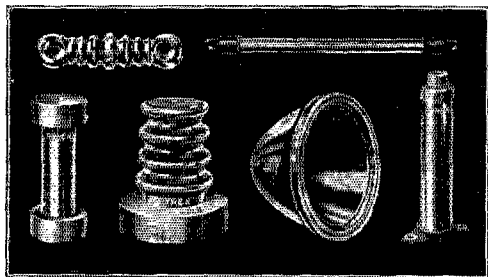

*For full utilization of radio energy,
use PYREX Insulators throughout*

PERFECT transmission or reception demands this. To know important differences between what your radio system should do and what it actually does, send for and read the PYREX Insulator booklet. Then if your dealer offers an inferior substitute, insist upon PYREX Insulators and if necessary, buy from us direct.

CORNING GLASS WORKS

Dept. 64, Industrial and Laboratory Division
Corning, N. Y.



microphone, a clock with pointers (nobody could see how late it was!), the receivers, a charging panel, a monitor, several switches, the r.f. power amplifier, and on the wall the antenna panel with a couple of G.R. hot-wire ammeters and three condensers to tune the feeders of our Zeppelin-system to any band desired. Around to the right we find the crystal oscillator, a 30-watt low-power transmitter, and the power panel. The receiving antenna is also used to hang several trophies, including some ex-champagne bottles. On the wall over the modulator panel is a complete wiring diagram of the whole darned works, to impress the visiting BCL's. Hi!

The transmission results during the show were splendid. Our phone, with 200-watt input, was heard in the Dutch East Indies, although the QRM of other demonstrations made the reception something which turned the average operator mad in about half an hour. Due to this, many QSO's were lost, and it was possible to copy only the loudest of loud signals. Many interested visitors who picked up the extra phones hanging near the railing laid them down instantly, with a face indicating wonder that it was possible to receive anything at all through the turmoil.

On the other side of the room the manager of our stationery office tried to sell huge masses of *QST*'s, handbooks, and other material of similar nature. The rest of this booth gave a description of international and national amateur organizations, lots of photos (including the I.A.R.U. Congress at Paris, and of Mr. Maxim and Mr. Warner between them) and piles of ham apparatus of both recent and by-gone days. There was also an exhibit of wavemeters made by our QRH office, and other apparatus.

It was a great thing, that radio exhibition. Heaven only knows how many hours the members of the Hague section of the N.V.I.R. worked to get things fixed up. That last night before the opening of the show, when not a single milliwatt would go into the antenna, and the "insides" of the power panel started to go up in smoke suddenly, will last forever in the memories of those present.

We kept awake that night only through the assistance of pepper-and-mustard sandwiches (cut up with tin-snips, incidentally) and many drinks out of a pyrex bowl.

By the time this gets into print, PAOAA will have become only a memory — but not a dim one. Once more amateurs have shown to the outer world a tiny bit of that strong spirit which will hold us together forever — international HAM SPIRIT.

BRITISH NOTES

From R.S.G.B.

No outstanding features were noticed during the early part of the summer. On the 7-mc. band conditions were normal for the time of the year. This band, owing to severe interference, is being neglected by many Britishers. Much of the trouble is due to the invasion of semi-commercial sta-

JUST OUT!

September 1929

With these big features—

NEW AMATEUR CALLS

In many countries, due to the adoption of the new Prefixes, lists of amateur calls have been changed completely.

WHO'S WHO ON SHORT WAVES

A brand new section, giving frequency, call, and location of commercials, shortwave fones, television stations, etc., heard between 3,000 and 30,000 Kilocycles.

NEW PREFIXES

You need this big number to identify stations heard, new Prefixes, such as D, OA, X, ZS, etc. We have the most complete list published.

Issued quarterly, March, June, September and December. Single copies \$1.00 each in U. S. and Canada, \$1.10 Foreign. Yearly subscription \$3.25, Foreign \$3.50.

RADIO AMATEUR CALL BOOK, Inc.

506 South Dearborn St., Chicago, Ill.

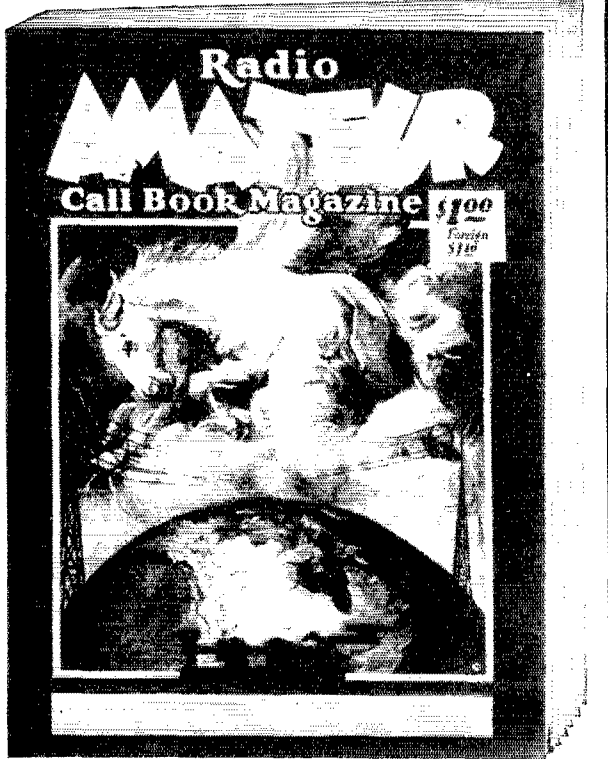

WIRELESS EGERT ENGINEERING INC.

179 GREENWICH ST., N. Y. City

WE

eliminate any type of man-made static.

design and construct special Radio and Electrical relaying systems.

build Special Transmitters, and long or Short wave receivers to order. Amplifiers constructed and designed to order.

See the new SHORT WAVE 4 Just Announced by our Company. The Best Short Wave Set you can buy to-day.

DAY AND EVENING CLASSES IN

RADIO OPERATING

Next terms start Sept. 1st and Oct. 15th

For further information and circular, address

The Registrar

FEDERAL RADIO AND RAILWAY INSTITUTE

517 Wells Street

Milwaukee, Wisconsin

TRANSFORMERS

Guaranteed — Mounted — Complete

2 K. W. 2000—2500 each side..... \$40.00

700 watt 1000—1500 each side..... 14.50

250 watt 500—750—1000 each side

unmounted \$9.75; mounted \$11.50

Auto-Transformers, Chokes, Polyphase and 25-cycle

Transformers. Add \$2.00 for fil. winding

9CES FRANK GREBEN

1927 So. Peoria Street, Pilsen Sta.

Chicago, Ill.

It Teaches the Code!

Learn Telegraphy with TELEPLEX

TELEPLEX is the practical code instructor. Works like a phonograph. Waxed tape records send signals like a real operator. Complete code instructions furnished with every Teleplex. Sends messages, radiograms, etc.—regular code traffic like an expert operator. Used by all leading schools. Endorsed by U. S. Navy. **Guaranteed to teach you the code or it costs nothing.** Speedy, simple, clear. Ideal for advanced students or beginners.

FREE 10 DAYS TRIAL!

So sure are we that you will be absolutely satisfied with your purchase, that we will let you try it in your own home **ON 10 DAYS FREE TRIAL!** You are the sole judge. Where can you match that astounding offer? **ACT TO-DAY!** Write for full facts about Teleplex. No obligation.

TELEPLEX CO., Dept. I-12, 76 Cortlandt St., New York, N. Y.

Chi-Rad's

New 1930

RADIO CATALOG

Sent FREE to Set Builders

NOW ready — Chi-Rad's latest money-saving catalog. All the latest parts, accessories, kits and sets such as: — New Super-Wasp Shield-grid Short Wave Receiver, kit \$29.40 or completely constructed \$42.50; New National Shield-grid Short Wave Receiver, kit \$33.00 or completely constructed \$39.00; 3000 volt New type R3 Rectobulbs \$10.00.

Send today for your free copy

Chicago Radio Apparatus Co.

Dept. Q

415 S. Dearborn St., Chicago, Ill.

tions into the band and the continued use of high power for local use. At certain hours DX is quite impossible, but many stations continue using their high-power sets, knowing that they could effect QSA5 contacts with less than 10 watts. Unless concerted action is taken shortly it will cause many low-power stations to leave this band permanently.

On 14 mc, conditions continued to be favorable, but towards the end of May, VK stations were weaker in the early morning. It was noticed on the evening of May 21st that local European and W stations were both very loud. This is rather an unusual phenomena.

On 28 mc, very little actual DX has been accomplished, but many G stations are active, and as soon as conditions improve it is anticipated that much new work will be done.

Interest on 56 mc. is increasing, and in this connection it is pleasing to record that two British amateurs, Mr. Parry (G6PY) and Mr. Somerset (BRS125), have offered special prizes to be won by the pioneer DX men on these ultra-high frequencies. R.S.G.B. will be pleased to put foreign or colonial amateurs in touch with their members experimenting on 56 mc.

In connection with the QSL card forwarding service of the R.S.G.B., we wish to advise all amateurs that in future we shall be pleased to handle cards from all foreign amateurs, providing they are sent to the Headquarters, at 53 Victoria St., London, S.W. 1.

The Fourth Annual Convention of the Society will be held in London on September 27-28, and on this occasion we hope to welcome many of our overseas and foreign colleagues. The annual Radio Exhibition will take place at Olympia, London, from September 23d to October 2d.

AUSTRALIA

From W.I.A.

Every month shows an increased development in the activities of the Australian Section and a stronger position in the Radio World. The amateur movement in Australia has now reached the useful position where we are recognized as the authority on matters pertaining to short wave and low-powered transmitting apparatus, and a number of requests have been received lately by the Federal Executive of the Institute for assistance in solving technical problems. At an inquiry conducted by the Commonwealth Government recently into the cause of a number of aeroplane accidents in which radio equipment was proved to be obsolete, the Institute was requested to give evidence and suggest measures for future action to insure the successful functioning of the radio equipment in the event of a forced landing. The recommendations have been embodied in the report of the Commission.

Considerable interest has been taken in the high frequency test of the G. E. Co. through W2XAW for July and August, and arrangements have been made for extensive observation to be taken in every State of the Commonwealth. The

FROST-RADIO

wants you to have a copy of its valuable 16-page Parts Catalog

We want every reader of QST who has not yet received a copy of our big 16-page Parts Catalog to use the coupon for requesting his copy today. This catalog contains a vast amount of useful information, in addition to illustrating and describing the complete line of Frost-Radio parts and accessories. It describes our big special offer to radio set builders. It tells about special book-ups, short cuts, "how to do things better." Get your copy of this book right away. Remember, it's FREE for the asking. So just mail the coupon now and get your copy by return mail.

HERBERT H. FROST, INC.

Main Office and Factory: ELKHART, IND.

HERBERT H. FROST, Inc.
100 North La Salle Street, Chicago
Send me your big 16-page Parts Catalog by return mail. I understand that it will be sent to me FREE and postpaid.

Name
Address
City State

FINAL TESTS

Naturally — every TRIAD tube is constantly, rigidly tested throughout its entire manufacturing process — a special test follows each individual operation. Yet TRIAD does more than that! When completed, each TRIAD tube is subjected to nine additional and final tests for vital characteristics — tests so stringent that nothing short of absolute perfection can survive them! This infinite care has made possible the guarantee that goes with every TRIAD tube — a minimum of six months' satisfactory service or a proper adjustment.

Tune in on the TRIADORS every Friday evening, from 8 to 8.30 P.M. (Eastern Daylight Time) over WJZ and associated N.B.C. stations.

TRIAD MFG. CO., Pawtucket, R. I.

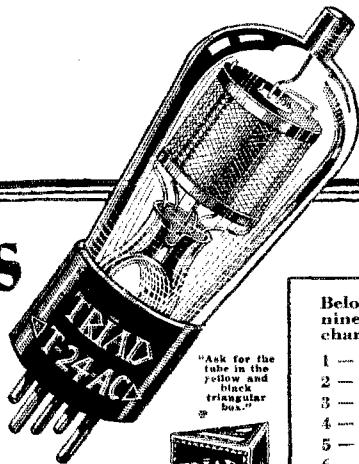

"Ask for the tube in the yellow and black triangular box."



Below are listed the nine final tests for vital characteristics.

- 1 — Gas
- 2 — Emission
- 3 — Filament current
- 4 — Plate current
- 5 — Oscillation
- 6 — Grid Voltage
- 7 — Multiple conductance
- 8 — Plate Impedance
- 9 — Amplification constant

TRIAD

INSURED

RADIO TUBES

BECOME A RADIO OPERATOR

See the World, Earn a Good Income,
Duties Light and Fascinating
LEARN IN THE SECOND PORT U.S.A.

Radio Inspector located here. New Orleans supplies operators for the various Gulf ports. Most logical location in the U. S. A. to come to for training.

Nearly 100% of radio operators graduating on the Gulf during the past seven years trained by Mr. Clemmons, Supervisor of Instruction.

All graduates placed. Runs to all parts of the world. Member of the A. R. R. L. — Call "W5GR." Day and Night Classes — Enroll any time.

Write for circular

GULF RADIO SCHOOL

844 Howard Ave. New Orleans, La.

HILET POWER TRANSFORMERS

Mounted 700 watts, 1000-1500 volts each side, \$14.50, unmounted 250 watts, 500-750-1000 each side, \$9.75, 100 watt 325 volts each side, two 7 1/2 V windings, \$6.50, 100 watt filament any voltage \$4.50 Chokes with adjustable core 250 MA \$7.50, 100 MA \$6.00. Specials to order. Write for lists and specifications. High-grade material and all guaranteed.

RADIO PARTS SALES CO. ORANGE, N. J.

SPECIAL TO AMATEURS

Barawik's new shortwavedept. has everything that amateurs desire. The Barawik Radio Guide gives full details. Send for it.

FREE RADIO GUIDE

SEND FOR IT!

Shows the latest wrinkles, newest developments in radio at startlingly low prices. Get the set you want here and save up to 50%. The best in parts, kits, complete factory-built sets and supplies. Orders filled same day received. Write for free 264-page copy NOW. Wholesale prices to set builders, dealers, agents.
BARAWIK CO. 119 Canal Sta., CHICAGO, U. S. A.



The NEW Easy-Working

VIBROPLEX No. 6

Reg. Trade Marks: Vibroplex; Bug; Lightning Bug

In Attractive Colors *Blue Green Red*

Hundreds of operators have traded in old models for this NEW Vibroplex, because it is EASIER to handle. Your old Vibroplex accepted as part payment

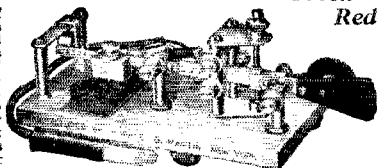

Blue, Green, Red or Black...\$17 Nickel-Plated....\$19

Famous Improved VIBROPLEX

Used by tens of thousands of operators because of its ease and perfection of sounding. Colors: Blue, Green, \$17 Red or Black \$19 Nickel-Plated.....\$19

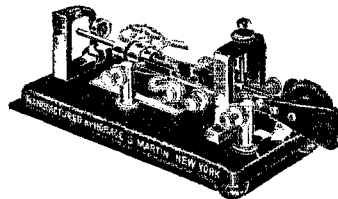

Special Radio Model Extra Large, Specially Constructed. Points for direct use without relay. Colors Blue, Green, Red or Black.....\$25

Specify color when ordering

Remit by Money Order or registered mail
THE VIBROPLEX COMPANY, Inc.
825 Broadway, New York City
Cable Address: "VIBROPLEX" New York

A NEW RUSH SERVICE

THE new addition to the Hardwick-Hindle Plant guarantees speed. In 72 hours it can begin turning out exactly the resistor you want.

The most modern equipment known — a huge new electrical furnace — an efficient, experienced personnel — all work together to provide the manufacturer with the resistor he wants *quickly*.

Our new catalog showing a complete range of resistors, mountings and brackets is yours for the asking. Send for it on your business letterhead.

HARDWICK, HINDLE, Inc.

Sales Dept.
122 Greenwich Street
New York City



Factory
215 Emmet Street
Newark, New Jersey

RESISTORS

Radio Operators

Send for this Folder
Now . . . It is **FREE**

If you really want to be a First Class operator — you can. Nature plays no favorites. She has given you the tools — **The Candler System** shows you how to use them. Overcomes every handicap. **DOUBLES** speed of slow operators. Makes fast operators **FASTER**. Puts you in **BIG PA Y** class in few weeks. McElroy, world's champion radio operator endorses no other system. Satisfactory results or no pay. Folder tells all about it. Send name and address now!

THE CANDLER SYSTEM CO.,
6343 So. Kedzie Ave., Dept. RL, Chicago, Ill.



Specialists in
STANDPEAK
**TRANSMITTING AND
FILTER CONDENSERS**

GERD ELECTRIC CO., INC.
187 SYLVAN AVE. NEWARK, N. J.

JACOBS ANTENNA SPREADER

Patented Sept. 8, 1925; Sept. 7, 1926
Both 5 in. and 7 in. diameters

A universal device made of metal for the quick and efficient construction of 4, 6 or 8 wire Cage antenna or counterpoise. \$8.00 per dozen; \$4.50 for a half dozen.

CHARLES F. JACOBS (W2EM)
279 Park Place Brooklyn, N. Y.

opportunity has also been taken of obtaining duplicate reports for our own use so that we can analyze the results and endeavor to discover something of the conditions affecting 28-mc. propagation. It is hoped that one result will be to prove whether the signals penetrate inland, as the work which has been attempted by men working there seems to indicate.

During the few months in which the Air Force Communication Reserve has been in operation, nearly 2000 words of traffic have been handled by reserve stations, and the success of the scheme has been better than we hoped for. A further development of our aero activities is the formation of a combined W.I.A.-Aero Club Section to undertake experimental work in connection with aero-plane installations. Experimental apparatus of members of the section will be utilized in planes supplied for the purpose by the Aero Club in each state.

A fair amount of short wave phone activity is taking place in all states at present on the 14-mc. and 7-mc. bands in addition to the usual phone on the special 200-meter band used temporarily by permission of the P.M.G. Department here.

28-mc. work during the past month has not been any better than reported previously, although the results being attained by high frequency men are very good. Weather conditions during most week-ends when the best part of the work is done have been for the most part anything but ideal. Arrangements are being made by several stations for work to be undertaken above 28 mc., but so far nothing definite has been attempted.

— W. G. Sones,

Hon. Publicity Officer to the Federal Executive.

We record with deepest regret the death of Phil Nolan, VK2YL, a leader in amateur work in Australia and one of the best-known amateurs in the world.



73 TO ALL THE HAMS 73

Power Transformers and CHOKES

At Less Than Manufacturer's Cost

This is the bankrupt stock of the Scanlan Transformer Co.

- No. 505 Power Amp. Secondary 600 volts — 600 volts, 1 1/4, 7 1/2 and 7 1/2. Center Tapped and 2 Chokes \$6.50
 For two 281, two 226, two 250
- No. 500 Secondary 300 volts — 300 volts, 1 1/2, 2 1/2, 5 and 5. Center Tapped and 2 Chokes \$4.50
 Will take care of a 10 tube set or less
- No. 875 Secondary 375 volts — 375 volts, 5, 5, 2 1/2, 1 1/2. High and low primary and 2 chokes \$4.25
 Suitable for a 10 tube set or less
- No. 413 Filament Transformers for six 236, one 227, and 2 171 A tubes \$1.95
- No. 644 Scott double chokes \$1.90
- No. 641 Scott Audio input transformer \$1.90
- No. 642 Scott Audio output transformer \$1.90
- No. 640 Scott Audio copper shielded \$1.90
- No. 30 Henry Chokes, unmounted,90
- No. 102 2 1/2 Amp. Dry Charger, less Raytheon cartridge \$1.50
- Vitrified Power Pack Resistances 180 volt, 16600 ohms, tapped at 1500, 7800, 15100 and 16600.95
- Used 5 tube radio sets in table model cabinets. Require minor adjustment \$6.90

Write for list

Chas. Hoodwin Co.

4240 Lincoln Ave. Dept. 827, Chicago, Ill.
BANKRUPT RADIO STOCKS

ROYAL-EASTERN

NEW 1930 Radio and Electrical catalog will be sent to you absolutely free of charge. Our new 1930 catalog is bigger and better than before — everything that is worth while in radio is listed. It is just chock full of the cream of electrical appliances and radio apparatus.

We are now booking orders for the new HAMMARLUND HI-Q 30.

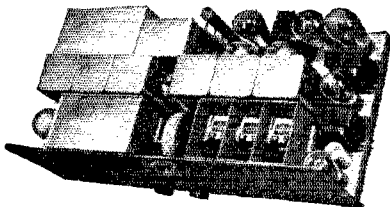

Send your order in early. The new Hammarlund job is a peach of a set — it surely does *perform* and we don't mean maybe. The new 1930 HI-Q is complete — everything goes on the chassis — power supply and tuner.

No outside power supply — Uses 3 A.C. Screen Grid Tubes; 1 A.C. CX-327 Detector Tube; 2 No. 45 Power Tubes in push-pull. Permanent phonograph pick-up outlet is incorporated. A real *one dial* receiver.

SEND YOUR ORDER PRONTO!

Of course, you want our catalog. So, write immediately. We know you will be pleased. Remember! — We have been serving the Electrical and Radio trade for 32 years. You realize what it means to do business with a well established firm.

ROYAL-EASTERN ELECTRICAL SUPPLY COMPANY
 12 West 22nd Street New York City, N. Y.

Branches:

Brooklyn Long Island City New Rochelle, N. Y.

SOME CLASS

To a station using mercury arc. Recent broadcast installation six-phase nine kilowatts. Commercials replacing 500 cycles with arc. They know why. A tip for relay and super-DX stations where absolute reliability and maximum kick must be realized to maintain the stations' dominating position. Unparalleled performance, instantaneous automatic starting, long life. Filters to pure DC for phone or CW. High peaks and overload limits.

RECTIFIER ENGINEERING SERVICE, Radio W8ML
 4837 Rockwood Rd., Cleveland, Ohio

MARVELOUS NEW PATENTED SCREW-HOLDING SCREW DRIVER

Non-magnetic. Holds screws tight! Removes them INSTANTLY from inaccessible places. Factories, radio, electricians, machinists, etc. buy on sight! Indispensable. Price \$1.50 only. (Sent postpaid receipt money order.) DISTRIBUTORS: (genuine opportunity, earn big money Exclusive territory. Write for details.

JIFFY-TITE MFG. CO. 1212 Water St. Boston, Mass.

A Radio Parts Guide

THE NEW YAXLEY Catalog



Send for it today for complete listings of Radio Convenience Outlets, Connector Plugs, Rheostats, Fixed and Grid Resistances, Jacks, Jack Switches, Phone Plugs, etc.

YAXLEY MFG. CO.

Dept. S, 1528 W. Adams Street, Chicago, Ill.

QST OSCILLATING CRYSTALS

Constant Temperature Control Equipment

We are now in a position to supply you with Thermostatically Controlled Heater units for accommodating two crystals (one used as a spare) with provision for instantaneous change-over, said unit maintaining a guaranteed constant temperature to a *ten-th of one degree Centigrade*. This unit is easily adjusted and is entirely automatic, operating from the 100-Volt supply mains. Delivery 10 days after receipt of order. Price \$400.00. More details upon request.

We also grind crystals for use in the Broadcast Band accurate to plus or minus 500 cycles of your assigned frequency for \$55.00 fully mounted.

Prices for grinding crystals in the Amateur bands are as follows:

1715 to 2000 Kc band	\$30.00, unmounted
3500 to 4000 Kc band	\$27.50, "
7000 to 7300 Kc band	\$45.00, "

SCIENTIFIC RADIO SERVICE

P. O. Box 86, Dept. F

The Crystal Equipment Specialists

Mount Rainier, Maryland

HAM-ADS

(1) Advertising shall pertain to radio and shall be of nature of interest to radio amateurs or experimenters in their pursuit of the art.

(2) No display of any character will be accepted, nor can any special typographical arrangement, such as all or part capital letters be used which would tend to make one advertisement stand out from the others.

(3) The Ham-Ad rate is 15c per word, except as noted in paragraph (6) below.

(4) Remittance in full must accompany copy. No cash or contract discount or agency commission will be allowed.

(5) Closing date for Ham-Ads is the 25th of the second month preceding publication date.

(6) A special rate of 7c per word will apply to advertising which, in our judgment, is obviously non-commercial in nature and is placed and signed by a member of the American Radio Relay League. Thus, advertising of bona fide surplus equipment owned, used and for sale by an individual or apparatus offered for exchange or advertising inquiring for special equipment, if by a member of the American Radio Relay League takes the 7c rate. An attempt to deal in apparatus in quantity for profit, even if by an individual, is commercial and takes the 15c rate. Provisions of paragraphs (1), (2), (4) and (5) apply to all advertising in this column regardless of which rate may apply.

PLATE POWER for your set, the very heart of its performance. For quietness DX ability, life-long permanence, absolute dependability, lowest ultimate cost, no other plate source even approaches the achievement of an Edison steel-alkaline storage B battery. Built painstakingly: every joint pure nickel, upset electrically welded. Genuine Edison Electrolyte. Our list describes complete batteries, construction parts, enameled aerial wire, silicon steel. Available immediately, filament and plate transformers for the new 866 rectifier, complete plate power units. Rectifier Engineering Service, radio W8ML, 4837 Rockwood Road, Cleveland, Ohio.

THE most complete line of modern short wave receivers for every particular service. Four to nine tube designs. Radiophone-CW transmitters, of any power or type. We make a complete line of apparatus including speech amplifiers, filter coils, transformers, rectifiers, variable condensers, inductances, etc. Any special apparatus, designs, made to order using your parts if desired. Prices on request. New bulletin lists complete line of apparatus. Write for copy. Ensell Radio Laboratory, 1208 Grandview Ave., Warren, Ohio.

SPECIALLY made rectifier aluminum with small percentage copper, stand more amperage, last longer, square foot \$1.25. Lead \$1.00. Elements, holes punched with bolts and nuts, new kind 1" x 1/2" 15c, 1" x 3/4" 17c, pair prepaid. Best Silicon steel 14" cut to order 25-35c lb. Postage extra. Geo. Schulz, Calumet, Mich.

AMATEURS—experimenters, builders. We serve over 4000 I.R.E., A.R.R.L., etc., experimenters and "nuts." Full discounts. 500,000 stock approved parts—no sets. Over four pounds catalog, circuits, data, prepaid, 50c. Weekly bulletins (new items, results of experiments, etc.) 20 weeks, \$1. Sample experimenters "Over the Soldering Iron" magazine, 25c. Transmitting data, price list, etc., 25c. Kladag Radio Laboratories, established 1920, Kent, Ohio.

PANEL engraving—finest workmanship on radio laboratory apparatus. Request price list. A. L. Woody, 19 S. Wells St., Chicago.

WANTED—Navy standard receivers, SE143, SE1220, SE1420, IP500, IP501—also spark gap units. State price and condition. Paul Trautwein, 38 Park Place, New York City.

WANTED—your radio wants. Parts for that receiver, transmitter or power supply. Special apparatus. Pontiac Engineering Co., 1100 Ave. I, Brooklyn, N. Y.

SPECIAL summer prices on crystals 3500 Kc band \$14.00, 1700 Kc band \$9.00. Blanks \$4.00. W9DRD, Herbert Hollister, Edwardsville, Kansas.

G. E. transformers 1100-2200-4400 each side center tap, used by Michigan, Cornell and Naval Reserve, \$12 f.o.b. Detroit. F. G. Dawson, 5740 Woodrow Ave., Detroit, Mich.

TRANSFORMERS—100 watt, 110 volt, 60 cycle, 750 volts each side center tap, one 7 1/2 volt filament winding, \$7.25. Same as above, but two filament windings, \$8. Above will operate two 210 tubes. Same as above, but 150 watts for operating two 250 tubes, \$9.25. Same as above, but 250 watts for operating two to four 210 or 250 tubes, \$11.50. Heavy construction, no heating, all mounted. Heavy duty transformers and chokes for amateur or broadcast stations supplied to specifications. Scott Coil & Transformer Co., New Albany, Miss.

NAVY Dynamotors General Electric 24/1500 volt, \$37.50; 24/750 volt, \$27.50; 12/350 volt, \$18. Crocker-Wheeler 24/1500 volt, 450 watt, \$15. Holtzer-Cabot 12/500 volt, \$20. Westinghouse 6-15 volt, 500 watt, \$15; 10/350 volt, \$18; 27.5/350, \$15. Twins for 700 volts, \$28. 900 cycle, \$22.50; 1/4 kw. 500 cycle, \$15. Complete list, Henry Kienzle, 501 East 84th St., New York.

FREQUENCY precision is the most urgent need of modern radio. Let us calibrate your new frequency meter from Piezo standards. American Piezo Supply Co., Dept. B, 1101 Huron Bldg., Kansas City, Mo.

QSL cards, Nuff sed, W8CUX, Millington, Mich.

LET us build or bid on your station, broadcasting, amateur phone, or CW. Satisfaction guaranteed. Prices the lowest in the country. Try us. Uncle Dave L. Marks, 117 North Pearl Street, Albany, N. Y.

TRANSMITTING tubes. Wanted any size. We buy any size station. What have you? Uncle Dave L. Marks, 117 North Pearl St., Albany, N. Y.

SPECIAL: Amertran 1200 volt each side of center 2-7 1/2 volt center tapped filament windings at \$8.00 each, 3/16 inch Signal Corp. silver contact keys 95¢ each, 30 Henry 150 mill, chokes \$1.90 each. Signal high frequency buzzers 95¢ each. Two microfarad 1000 volt unmounted condensers 85¢ each. Westinghouse Aeroplane generators \$4.50. Microphone cases \$2.25. Mershon condensers \$2.00 each. Flechtheim 1500 volt pig-tail leads one microfarad condenser \$2.75, with two microfarads \$4.50, with four microfarads \$6.50. Freshman 375 volt and two 7 1/2 center tapped windings \$2.75. Thordarson 220 and 285 volts center tapped transformer \$1.95. All sizes of variable condensers 75¢ to a \$1.00. Thousands of other buys. Send for monthly ham sheet. Uncle Dave, 117 North Pearl St., Albany, N. Y.

SELL—odd parts and meters. Write for list. Coe, Ft. Sam Houston, Texas.

NEW set Aero receiver coils \$4. Two REL 40 meter transmitting inductances \$3 each. One UX-860 \$22. One UX-852 \$30. One 15 volt AC filament meter \$5. W5AD

USED parts bought, sold, exchanged. W9CKA, Corwith, Iowa. QSL's, two color \$1.00. Samples, W9CKA, Corwith, Iowa.

BROADCASTING Generator Set with extra DC armature. Direct current 1500 volts, 1.5 amp. Alternating current single phase, 2 HP, 110-220 volts. Price \$125.00. Wright Appliance Company, Philadelphia, Pa.

TRADE—Almost new Remington typewriter for complete 1929 type transmitter. John C. McPhee, San Tan Apartments, Mesa, Arizona.

WANTED, Pacific Radio volume one or first six numbers of volume one. Ernest Ford, 305 South Wilson, Alhambra, Calif.

WESTON model 425 thermo-galvanometer, new in original boxes, \$8.25 each, postpaid. Frank Coates, 3605-5th Ave., Sioux City, Iowa.

BROADCASTING motor generator sets, 2000 volts, 1000 watts, 2 commutators, 3 phase drive, \$195. 1 phase drive \$215. 1000 volts 3500 R.P.M., 2 commutators, 1 phase drive 200 watts \$70. 300 watts \$85. 750 volts 3500 R.P.M., 2 commutators 1 phase drive 200 watts, \$45.00. 300 watts \$60. 500 volts 200 watts, 1 phase drive, \$35. 350 volts 150 watts 1 phase drive \$27.50. The above bargains are limited. We can furnish your needs in motor generators or motor-generator sets regardless of size or voltage. Write Du-Rite Electric Co., 1735 Maypole Ave., Chicago, Ill.

LAST time at this price. Polymet transmitting filter condensers 1000 d.c. working volts, 2 mfd, \$2.15. W1AOZ, Woodrow Darrow, Waterford, Conn.

W8AUL selling out some of his surplus apparatus. Write for list. 4414 Water Street, Wheeling, W. Va.

JEWELL No. 54, 0-2000 volt d.c. with external resistor, \$14. 0-1000, \$13. No. 74 0-750 volts a.c. \$11. Write for list and specification of chokes and transformers. M. Leitch, Park Drive, W. Orange, N. J.

5000V. 4000W. 7 1/2 Hp. 3-phase drive double commutator motor-generator, complete \$550. 500 Cycle 1 KW. ballbearing motor-generator, 110V. DC. drive \$175. 250 Cycle 1-1/2 KW. ball-bearing motor-generator 110V. DC drive \$165. 2-5 KW. Rotary spark gap 110V. DC drive \$35. 1000V. 200W. Escal 1-phase drive \$75; 300W. GE \$95. 750V. 250W. new General Electric motor-generators \$52.50, 200W. \$42.50. 32V. drive motor-generators, 750V. 150W. \$37.50; 200 W. \$42.50; 300W. \$65.00. 400V. 100W. generators \$8.50; 1/2 Hp. \$450 speed motors \$10.50; 1/2 Hp. \$16.50. 1/2 Hp. 110V. AC synchronous 1800 speed motors \$20. 8V. 5 ampere generators \$6.50. Queen City Electric, 1734 Grand Avenue, Chicago.

CRYSTALS: A-1 oscillators, one each of the following approximate frequencies: 3640, 3627, 3585, 3575, 3568, 3553, 3550, 3546, 3531, 3520 kc. \$11.50 each. C. E. Pearce, 427 Asia St., Baton Rouge, La.

HAMS: Get our samples and prices on printed call cards made to order as you want them. W9APY Hinds, 19 S. Wells St., Chicago, Ill.

AMAZING screw-holding screw driver! Factories, garages, workers buy on sight! Profit 75¢ each. Exclusive territory. Free trial offer. Jiffy 1184 Winthrop Bldg., Boston.

SELL National screen grid short wave receiver. Bargain at \$16. W8D(L), Rouseville, Penna.

QSLs, stock and individual. Cartoons, wall cards, voltage signs, etc. Seiden's, Cranesville, Penna.

55% discount on Karas 3-1 audio transformers, regular price \$2.25. Write us on National, Elkon, Weston, Electrad, Pilot, Yaxley, Sangamo, Signal, Frost, Tohe, Clarostat, and Hammarlund. Hatry & Young, Hartford, Conn.

WE build that special set. Four tube S-W band-spreading receiver, tuned audio if specified, \$75. QST all purpose superhets and kits. Hatry & Young, Hartford, Conn.

W6DXX reports: "Licensed in two weeks. Now do 25 per." For other reports see display section. C. K. Dodge.

SELL — 450 watt 100 watt dc generator, fine shape, \$12.00. 10 300 dynamotor, a bargain at \$12.00. W7EL, Stevensville, Montana.

THORDARSON 650-volt power-filament transformers for 7½-wattors \$6.90. Aluminum square-foot 85¢; lead 85¢. Potter Condensers: 1-mfd. 2000-test voltage \$2.50; 1-mfd. 2500-test \$3.25; 2-mfd. 1000-test \$2.50; 2-mfd. 2000-test \$4. "Ham-List" 4¢. Curtis Sales Company, 1109 Eighth Avenue, Fort Worth, Texas.

SPECIALS: Transformers and chokes for transmitters, public address and electric set power packs. From factory to you. Guaranteed. 110 volt 60 cycles, 150 watt, 500-0-500, 7½, \$4.50. 550-0-550, 8v, \$5. 650-0-650, 7½, 7½, \$7. 0-600, 7½, \$3. 250 watt 550, 750 each side, 8v, 8v, \$9. 10 volt 75 watt center tapped filament transformers \$2.75, 8v, 8v, 80 watt \$3. 10 to 50 Henry 250 MA adjustable choke \$5. Electric set transformers, 300-0-300, 5, 5, 2½, 1½, \$4. 350-0-350, 5, 2½, 2½, \$4.50. 650-0-650, 7½, 7½, 2½, 1½, \$9.50. 30H 85 MA double choke \$1.75. 50 H 125 MA double choke \$2.50. Condenser coils. Working voltage 540, 2-4-4-1-1 MF \$2.75. Uncased 2 MF, 45¢. 4 MF, 80¢. Cased 1 MF 1000 volt \$1.10. 2 MF \$1.90. 4 MF \$2.90. Transformers and chokes built to your specifications. Send for catalog. Electrone Laboratories, 834 N. Randolph St., Philadelphia, Pa.

BUGS, new 7 bucks, guaranteed. Glass lead-in bowls and fittings, \$1.50. W9GAC.

NATIONAL Thrill Box SW-4, six coils \$20. 730 Silver Marshall kit and cabinet \$8. General Radio wave meter 40-600 meters \$3. Radio Corp. UP-1368 power transformer \$10. Double R.E.L. transmitting inductance Type L \$4. Fifteen Dial Omnigraph, thirty dials \$8. Murdock 3000 head set \$1.50. W. Baker, 2300 Hoover Ave., Dayton, Ohio.

LEAVING for Brazil, complete station w/d power supply \$38. Pictures on request. Write W8DMK, Jewell Knoth, Utica, Ohio.

QSL cards, two colors, \$1.00 per hundred. Free samples. W8DTY, 257 Parker Ave., Buffalo.

OMNIGRAPHS, Teleplexes, transmitters, receivers, dynamotors, Vibroplexes, 50 wattors, "S" tubes, motor generators. Bought, sold, traded. Ryan Radio Co., Hannibal, Mo.

FILTER condensers: Freshmann unmounted 2 mfd., 2000 volt — 75¢. Four for \$2.60. Eight for \$4.80. Splittorf 19 mfd., 1000 volt working blocks — \$4.20. AmerIran type 250 power transformers, 250 watts, 120V, 7½, 7½, 10 volt center-tapped secondaries — \$11.75. 30 H, 150 MA power chokes. Mounted — \$2.25. 30 H, 100 MA — \$1.75. Imported 50 wattors — \$9.50. W.E. MicropPhones — 90¢. Pure rectifier elements: 1x4-9¢; 1x5-10½¢; 1x8-12¢. Send for "Specials". William Harrison, 35 Ft. Washington Ave., New York City.

WANTED — Two UV204As in perfect operating condition. W6UI 1761 East First St., Long Beach Calif.

WANT: Dynamotor. Sell or trade: RCA 210, 281, 203-A, 211, 852, 204-A, WE211D, 212D, 85 and 170 meter Ntals; Leach relay, Jewell meters, Super-Wasp receiver, mercury arc, Recto-bulbs, sync, 500 watt tube, bug, Teleplex, condensers, transformers. Write for anything you need. W9ARA, Butler, Mo.

BEST cash offer takes oscillator-amplifier transmitter described in February 1928 QST. Dudley, c/o QST.

RADIO MEN WANTED

FOR TALKING MOTION PICTURES
FOR AIR TRANSPORT LAND STATIONS

These are but two new fields in which men with radio training are employed. Our modern, rapid, efficient, and thorough courses of instruction are so arranged that a man with previous training may take only the subjects he needs or desires.

MARINE, BROADCAST, SERVICE AND SPECIAL COURSES

Write for prospectus

EASTERN RADIO INSTITUTE

899 BOYLSTON ST. BOSTON, MASS.

Established 1913. Recommended by A. R. R. L.

Q R A SECTION

50c straight with copy in following address form only:

W2BCH — A. S. Harrison, 6941-62nd St., Glendale, L. I.
W2QO — L. C. Hardy, 50 Lindsley Ave., Newark, N. J.
W8AX — Edward M. Glaser, 1182 First St., Muskegon, Mich.
W8LE — Marcus Glaser, 1182 First St., Muskegon, Mich.

W1MK

A. R. R. L. Headquarters

R. B. Parmenter, Chief Op. "rp."

The following calls and personal sines belong to members of the A. R. R. L. Headquarters gang:

W1BDI-W1XL F. E. Handy "fh."
W1BEH-W9BR — B. Dudley "hd."
W1EH K. R. Warner "kb."
W1BUD A. L. Budlong "bud."
W1CEI J. J. Lamb "jm."
W1ES A. A. Hebert "ah."
W1FT-W2JR — G. Donald Meserve, "dm."
W1PX C. G. Kenefick "ek."
W1SZ-W1BIZ C. C. Rodimon "rod."
W1UE E. L. Battey "ev."

Do you know that the 1929 Handy and Hull Handbook is available in bound form — \$2.00 per copy, postpaid?

When ordering a copy of this new fifth edition, look at your present copy and determine if you want the 1929 copy in more permanent form.

PIERCE AIRO Gardwell
Dubilier THE ACME WIRE CO.
PYREX WESTON
RADIO ENGINEERING LABORATORIES
Raytheon Ward Leonard
Farrand ELKON
Knapp ELKON PARVOLTS
AD. AURIEMA, Inc.
Manufacturer's Export Managers
116 Broad Street, New York, N. Y.
Scientifically equipped to economically export dependable receiving and transmitting radio apparatus

To Our Readers who are not A.R.R.L. members

WOULDN'T you like to become a member of the American Radio Relay League? We need you in this big organization of radio amateurs, the only amateur association that does things. From your reading of *QST* you have gained a knowledge of the nature of the League and what it does, and you have read its purposes as set forth on page 6 of this issue. We should like to have you become a full-fledged member and add your strength to ours in the things we are undertaking for Amateur Radio. You will have the membership edition of *QST* delivered at your door each month. A convenient application form is printed below — clip it out and mail it today.

A bona fide interest in amateur radio is the only essential qualification for membership

AMERICAN RADIO RELAY LEAGUE
Hartford, Conn., U. S. A.

I hereby apply for membership in the American Radio Relay League, and enclose \$2.50 (\$3 in foreign countries) in payment of one year's dues, \$1.25 of which is for a subscription to *QST* for the same period. Please begin my subscription with the issue. Mail my Certificate of Membership and send *QST* to the following name and address.

.....

.....

Do you know a friend who is also interested in Amateur Radio, whose name you might give us so we may send him a sample copy of *QST*?

.....

.....

Thanks

For Your Convenience

QST'S

INDEX OF ADVERTISERS IN THIS ISSUE

Acme Wire Company	80
Aero Products, Inc.	3rd cover
Aerovox Wireless Corporation	80
Allen-Bradley Company	74
Aluminum Company of America	75
American Piezo Supply Co.	83
American Sales Company	51
Arcturus Radio Company	70
Aurlema, Inc., Ad	93
A.R.R.L. Application Blank	94
A.R.R.L. Bookshelf	77
A.R.R.L. Handbook	2nd cover, 93, 83, 85
Barawik Company	85, 89
Broadcasters Service Bureau	83
Burgess Battery Co.	4th cover
Candler System Co.	90
Cardwell Mfg. Corp., Allen D.	79
Central Radio Labs	76
Chicago Radio Apparatus Co.	88
Corning Glass Works	86
Crosley Radio Corp.	2
Cunningham, Inc., E. T.	68
Dodge, C. K.	84
Dongan Elec. Mfg. Co.	82
Eastern Radio Institute	93
Electrad, Inc.	84
Electric Specialty Co.	83
Ewing, Jr., Edwin C.	86
Federal Radio & Railway Institute	87
Ferranti, Inc.	64
Frost, Inc., Herbert H.	88
General Radio Company	4
Gerl Electric Company	90
Greben, F.	87
Gulf Radio School	89
Hardwick, Hindle, Inc.	90
Hoodwin Co., Chas.	91
Jacobs, Chas. F.	90
Jewell Electrical Instrument Co.	69
Leeds Radio Company	71
Loomis Publishing Co.	83
Manhattan Electric Bargain House	73
Massachusetts Radio School	76
McGraw-Hill Book Co.	66
Milten Mfg. Company	91
National Carbon Company	95
National Company	85
National Radio Tube Co.	85
Paacent Electric Co.	85
Radio Amateur Call Book Co.	87
Radio Engineering Labs.	63
Radio Paris Sales Co.	89
Radio Specialty Company	78
Radio-Victor Corporation of America.	71
Rectifier Engineering Service	91
Rooney, John T.	85
Royal Eastern Electrical Supply Co.	91
Saugamo Electric Co.	Insert
Scientific Radio Service	91
Shallcross Company	78
Silver-Marshall, Inc.	65
Teleplex Company	87
Thordarson Elec. Mfg. Co.	67
Triad Electric Co.	89
Van Nostrand Company, D.	96
Vibroplex Company	89
Western Radio Mfg. Co.	76
Weston Electrical Instrument Corp.	72
Wireless Expert Engineering	87
Yaxley Mfg. Company	91

▶▶▶ WITH **EVEREADY**
RAYTHEON 4-PILLAR
TUBES, YOU CAN GET THE MOST
 FROM YOUR PRESENT RADIO RECEIVER

People in all parts of the country are telling of the greater power, increased distance, improved tone, and quick action of these remarkable new tubes. The reason is that Eveready Raytheons are built stronger — immune to the bumps and jolts of shipment and handling.

They come to you in as perfect condition as when they leave our laboratory test-room.

The Eveready Raytheon *4-Pillar construction* is exclusive and patented. Examine the illustration at the bottom of this page. See how the elements of this tube are anchored at eight points.

screen-grid type which have heavier elements, and in tubes used for push-pull audio amplification, where uniform characteristics are most essential. Eveready Raytheon *4-Pillar* tubes come in all types. At your dealer's. He also has the famous BH tube for "B" units.

This is of particular importance in tubes of the 280 rectifier and 224

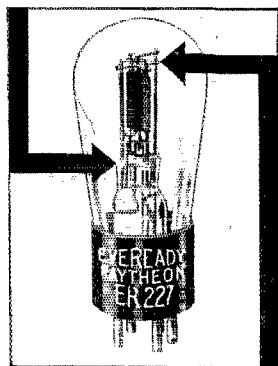

Showing the exclusive, patented Eveready Raytheon *4-Pillar* construction. Note the sturdy four-cornered glass stem, the four heavy wire supports, and the bracing by a stiff mica sheet at the top.

NATIONAL CARBON CO., Inc.

General Offices:
 New York, N. Y.



Unit of Union Carbide
 and Carbon Corporation



TRADE MARKS



Eveready Raytheon Screen-Grid tube, ER 224. Without Eveready Raytheon's *4-Pillar* construction, this type of tube is delicate, liable to severe damage in shipment.

Here's Something You've Been Waiting for—
The First American Book on
TELEVISION

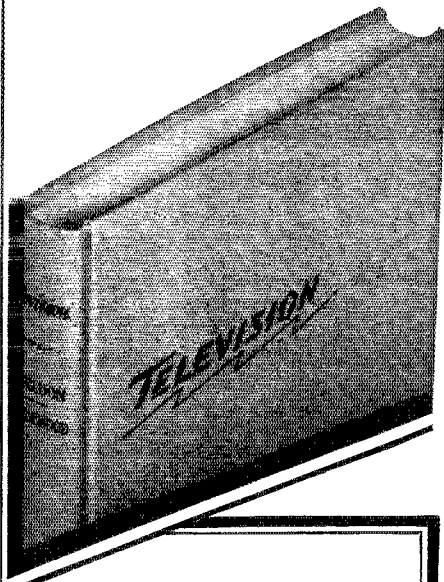

A Handbook for Operators, Experimentors, and Students Who Want to Keep in Step with the Progress of This New Science

Every radio operator and experimenter has wanted a complete, scientific exposition of TELEVISION — and now at last it is available in a book that presents fully the theory, the problems of practical application, and the solutions of those problems as they have thus far been worked out. The book has been prepared by two well-qualified authorities:

**H. HORTON SHELDON and
E. N. GRISEWOOD**

of the Department of Physics, New York University

This is a pioneer work — the first American book on the subject — and has been written from the viewpoint of the American student concerned either with operation or construction.

A Practical Guide Book

It first offers a clear cut understanding of fundamental theory; explains the operating methods; gives detailed descriptions of the apparatus thus far developed; and demonstrates the operating methods and problems of the various types of practical television systems. Supplemental descriptions are included of the latest amateur equipment and television circuits — data of great practical value to those interested in either operation or construction. All the information is right up to the minute. Many illustrations add greatly to the value of the book.

Examine It Free

You will want to judge for yourself the value of the book and we will be glad to place a copy in your hands, without cost or obligation, for ten days' examination. Within that time either return the book to us or remit its price — \$2.75. Order on the approval coupon below.

Order on This Coupon

D. VAN NOSTRAND COMPANY, Inc.,
250 Fourth Avenue, New York.
Send me "TELEVISION" for examination. Within ten days after receipt I will either return the volume or send you \$2.75 — the price in full. (QST 9-29)

Name.....
Street and Number.....
City and State.....
Profession.....

**A Brief Outline
Of the 18 Chapters**

1. Elementary television and picture-transmission.
2. Historical development of television.
3. Fundamental optical principle underlying television systems.
4. Action of electromagnetic waves in television.
5. Light-Sensitive Cells: the selenium cell.
6. Photo-electric cell: reaction and use in television.
7. Neon; Raytheon-Kino, Aeo lights, glow lamps in making talking pictures.
8. Oscillographs: Thomson tube, Braun tube, Cathode ray oscillograph in television circuit.
9. Scanning, Bell, Alexanderson, Dauvillier, Baird, and Jenkins systems.
10. Synchronization in television and in telephotography.
11. Telephotography: Bartlane, Ranger, Bell, and Westinghouse facsimile system.
12. Baird Televisor: color television; phonovisor.
13. Bell System: most elaborate demonstration on television.
14. Jenkins System: Complete details of first simple, inexpensive, and compact picture-transmission receiver.
15. Alexanderson System: latest television system. Mainly described in words of Mr. Alexanderson as given before American Institute of Electrical Engineers.
16. Relays: operation and adaptation of moving-coil galvanometer, Knowles relay.
17. Amateur Equipment: Use of screen-grid tube (222) and resistance-coupled amplification in television receivers. Neon tube circuit, Scanning-disc and motor, Framing of image.
18. Future of television.

AERO COIL

ANNOUNCEMENT!

*New Radio Apparatus
Soon to be Announced
For Benefit of Radio Amateurs*

AERO PRODUCTS, INC., will have some unusual new developments to announce within a short time. For a considerable period, our laboratories have been working on some outstanding improvements of particular interest to every radio amateur. These new items will be very desirable, particularly to the amateur who wants the very latest in short-wave apparatus.

Send Now for Advance Information

Readers of *Q.S.T.* and all amateurs who read this message may write in now to secure advance information on these new developments the minute they are ready to be released. It will pay you to have the information on these new products before you.

Mail This Coupon for Advance Information

AERO PRODUCTS, INC., Dept. 399
4611 E. Ravenswood Avenue, Chicago

Dear Sirs:

Please send me advance information on the new short-wave developments now being perfected in your laboratories as announced in September issue of *Q.S.T.*

Your Name

Street and Number

City

State

U.S.A. 9-29

4611 E. Ravenswood
Ave., Dept. 399

AERO PRODUCTS
INCORPORATED

Chicago, Illinois,
U. S. A.

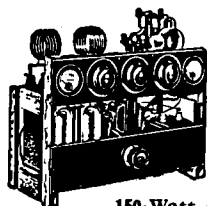

Aero
High-
Power
Xmitter
and

150-Watt Amplifier

For operation on 10-20-40-80-100M. Bands. The first high-power amplifier to use the UX-360 screen grid tubes. 1929 in every detail. 150 Watts of pure D.C. signals with a stability which has caused favorable remarks everywhere. Flexibility that fills every Ham need.

Kit No. 52 — Including the power supply, but not including tubes. List Price. \$259.00
Kit No. 53 — Less power supply and tubes. List Price. \$114.00

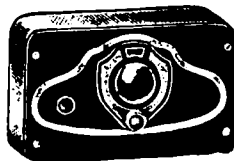

Only
\$15

Aero Listening Monitor

Enables any amateur transmitter to check his own note, to know whether it is pure D.C. or not. It is a safe, sure and accurate way of knowing your station without depending upon the reports of others. Watching the ammeter won't help you — you need the Aero Monitor to be absolutely positive.

Model M-29 Aero Monitor, including Dry Batteries, but no tube. List Price. \$15.00

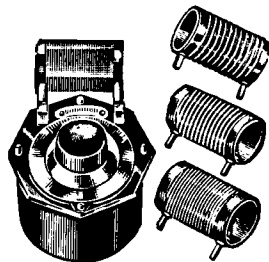

Aero Wavemeter

Using the principle of the "series gap" condensers, and having a definite fixed minimum capacity, the amateur wavelength bands are spread over a great many dial divisions. The velvet vernier dial has 100 divisions, each of which may be read to one-tenth of a division. Each wavemeter is individually hand calibrated. Standard coils shown are 20, 40 and 80 meters, included in price. 5- and 10-meter coils extra.

List Price, each. \$24.00

Aero Shield-Grid Coils

LWT-11 Kit of 3 coils (16 to 90 meters) \$11.50
LWT-10 Kit of 3 coils. List. \$10.50

Aero Transmitting Coil Kits

2040-K — 16 to 52 meter kit \$12.00
4080-K — 36 to 90 meter kit \$12.00
9018-K — 72 to 190 meter kit \$12.00

Inside Information!

Inner seal cementing cells into a solid block

Moisture-proof insulating cell partitions.

Moisture-proof inner container

Double top seal

One piece, drawn, seamless zinc can

Moisture-proof cell wrapper

Black and white striped water-proof container

Re-inforcing strip in top seal

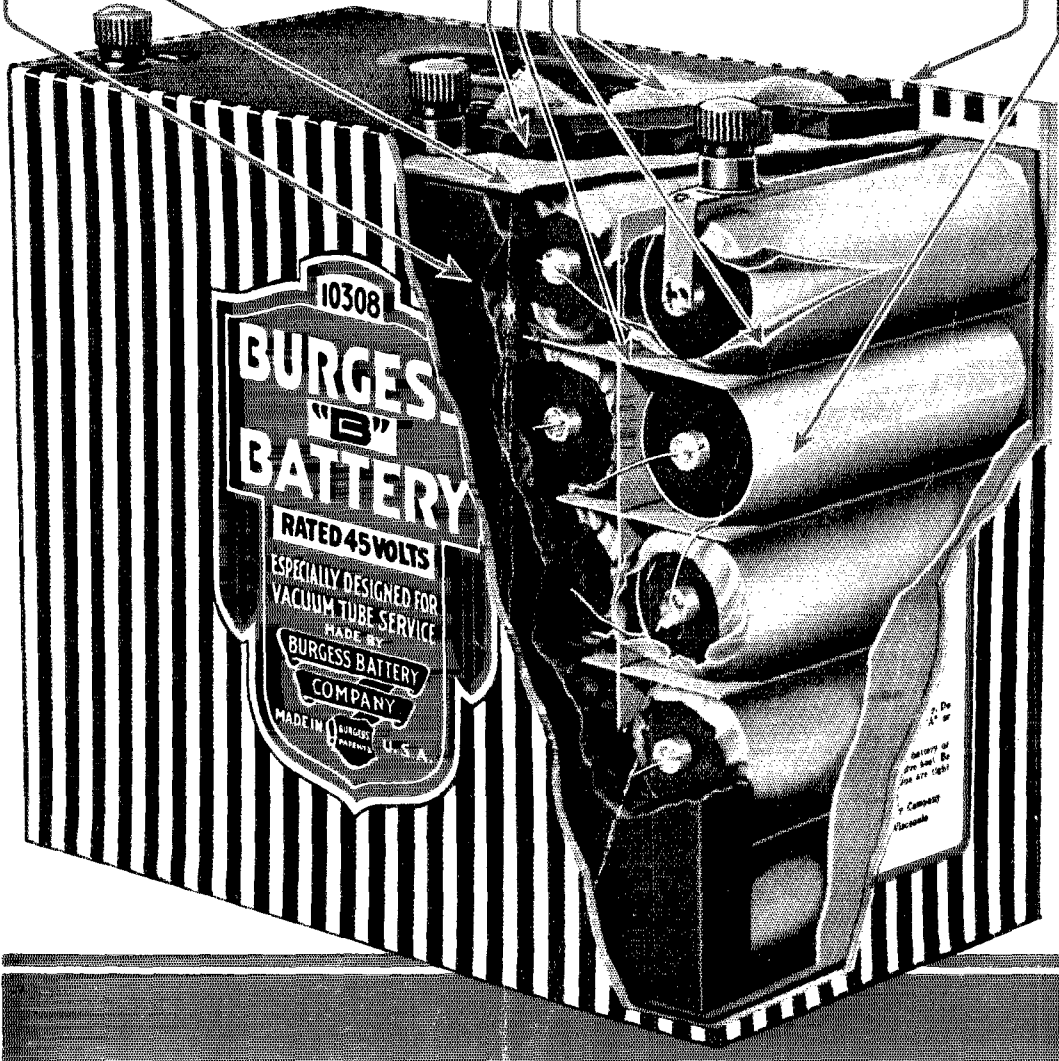

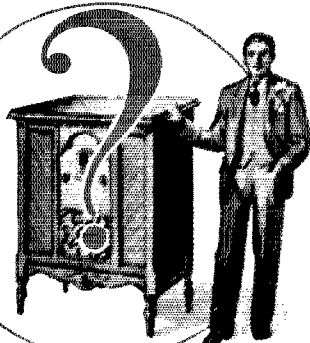

Will it be a sale?

At that critical moment—when one of your dealers is actually demonstrating one of your sets—when the whole family of Mr. and Mrs. Prospective Buyer are passing judgment with their ears—how about the audio end? Will it make the sale?

Will your dealer after the demonstration feel that it *might* have been a

sale if only he had a different line—or will he know that your product backs up his sales efforts?

Today it is *tone* which counts! And that is the reason why many receiver manufacturers are buying transformers from "Sangamo". They know it takes the precision manufacturing of a plant like Sangamo to turn out audio transformers, chokes and impedances that are uniformly of the same high standard.

The risk of *not* having the audio end of the receiver so good as Sangamo is too great to take chances. Real transformer building is a specialty in itself; it is best left to an organization like Sangamo whose research, experience and precision manufacturing facilities guarantee the results.



SANGAMO ELECTRIC CO.

SPRINGFIELD, ILLINOIS, U. S. A.

Manufacturers of precision electrical apparatus for 30 years

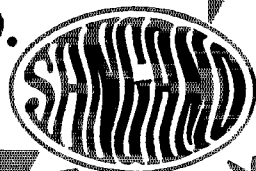

See reverse side

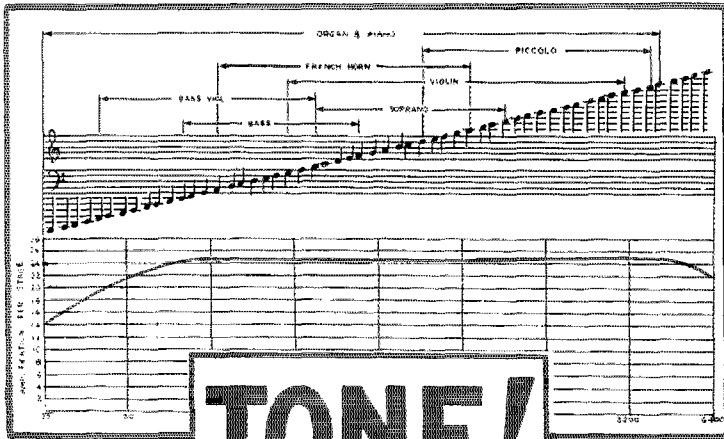

TONE!

Curve of Type "X" or "AX" Sangamo Straight Audio Transformer showing uniformity of amplification at all audible frequencies.

"X" Line Transformers

Type AX straight audio amplification.

Type BX Push-pull Input unit.

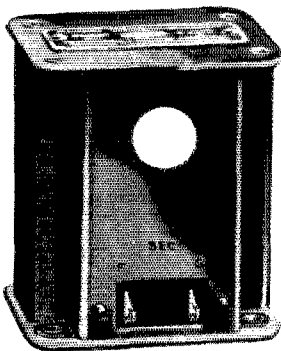

Type CX-171 Push-pull Output Transformer, for 171 or 250 power output tubes for cone speaker.

Type DX, same as CX except for 210 and 112 power tubes.

Type HX Push-pull Output for 171 or 250 Power Output tubes to match the impedance of moving coil of Dynamic loud speakers.

Type GX, same as HX except for 210 and 112 power tubes.

Type E output choke to match impedance of the various type power tubes.

Unusual facilities for furnishing transformers with or without cases ready for mounting and quick assembly with the receiver. Prices on application.

PIN THIS TO YOUR LETTERHEAD AND MAIL
SANGAMO ELECTRIC CO., Springfield, Illinois, U. S. A., Dept. 812

I am interested in engineering data regarding your transformers and condensers.

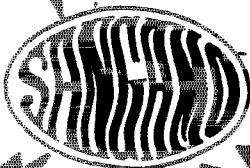

SANGAMO Condensers

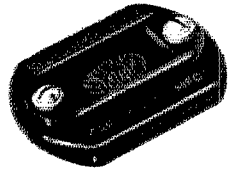

No item can cost so little and cause so much trouble in a receiver as a fixed condenser. This fact is especially appreciated by the manufacturer with an eye to the service problem. Likewise, experience has shown that a fixed condenser is not necessarily a good condenser just because it is molded in Bakelite.

The immunity to thermal changes and to mechanical damage rendered by the Bakelite enclosure is supplemented in Sangamo Condensers by accurate rating and sound construction of the mica condenser within the Bakelite casting.

The standard line of Sangamo Fixed Condensers leaves the factory tested to maximum variation of 10%.

NEW! Condensers for Manufacturers

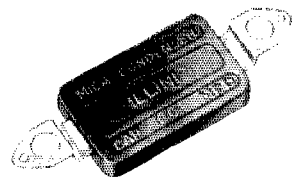

While the Sangamo Condensers shown at the top of the page have always been popular with manufacturers, there has been a demand for condensers of the same quality of a size and shape more suitable for factory set design and production. For manufacturers' use only, we have designed the Sangamo "Illini." The connecting lugs may be bent to any position required without impairing the condenser.

Prices on Request